

Description:

This N-Channel MOSFET uses advanced trench technology and design to provide excellent $R_{DS(on)}$ with low gate charge.

It can be used in a wide variety of applications.

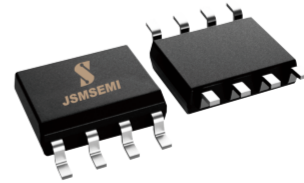

Features:

- 1) $V_{DS}=30V, I_D=20A, R_{DS(ON)} < 6.5m\Omega @ V_{GS}=10V$
- 2) Low gate charge.
- 3) Green device available.
- 4) Advanced high cell density trench technology for ultra low $R_{DS(ON)}$.
- 5) Excellent package for good heat dissipation.

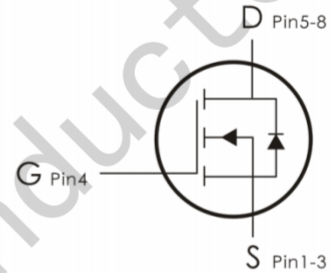

Absolute Maximum Ratings: ($T_J=25^\circ C$ unless otherwise noted)

Symbol	Parameter	Ratings	Units
V_{DS}	Drain-Source Voltage	30	V
V_{GS}	Gate-Source Voltage	± 20	V
I_D	Drain Current – Continuous ($T_A=25^\circ C$)	20	A
	Drain Current – Continuous ($T_A=75^\circ C$)	15.2	
I_{DM}	Drain Current – Pulsed ^① ($T_A=25^\circ C$)	76	
I_S	Diode continuous forward current ($T_A=25^\circ C$)	5	
P_D	Power Dissipation ($T_A=25^\circ C$)	3.1	W
T_J, T_{STG}	Operating and Storage Junction Temperature Range	-50 to +150	$^\circ C$

Thermal Characteristics:

Symbol	Parameter	Max	Units
$R_{\theta JA}$	Thermal Resistance, Junction to Ambient	40	$^\circ C/W$

Electrical Characteristics: ($T_J=25^\circ\text{C}$ unless otherwise noted)

Symbol	Parameter	Conditions	Min	Typ	Max	Units
Off Characteristics						
BV_{DSS}	Drain-Source Breakdown Voltage	$V_{GS}=0V, I_D=250\ \mu\text{A}$	30	---	---	V
I_{DSS}	Drain-Source Leakage Current($T_A=25^\circ\text{C}$)	$V_{DS}=30V, V_{GS}=0V$	---	---	1	μA
	Drain-Source Leakage Current($T_A=125^\circ\text{C}$)	$V_{DS}=24V, V_{GS}=0V$	---	---	100	μA
I_{GSS}	Gate-Source Leakage Current	$V_{GS}=\pm 20V, V_{DS}=0V$	---	---	± 100	nA
On Characteristics						
$V_{GS(th)}$	GATE-Source Threshold Voltage	$V_{GS}=V_{DS}, I_D=250\ \mu\text{A}$	1	1.6	2.5	V
$R_{DS(on)}$	Static Drain-Source On Resistance ^②	$V_{GS}=10V, I_D=15A$	---	5.2	6.5	$\text{m}\Omega$
		$V_{GS}=4.5V, I_D=8A$	---	7.5	9.5	$\text{m}\Omega$
Dynamic Characteristics						
C_{iss}	Input Capacitance	$V_{DS}=15V, V_{GS}=0V,$ $f=1\text{MHz}$	---	1320	---	μF
C_{oss}	Output Capacitance		---	205	---	
C_{rss}	Reverse Transfer Capacitance		---	135	---	
R_g	Gate Resistance	$f=1\text{MHz}$	---	4.4	---	Ω
Switching Characteristics						
$t_{d(on)}$	Turn-On Delay Time	$V_{DD}=15V, I_D=3A$ $R_G=3.3\ \Omega, V_{GS}=10V$	---	11	---	ns
t_r	Rise Time		---	30	---	ns
$t_{d(off)}$	Turn-Off Delay Time		---	24	---	ns
t_f	Fall Time		---	8	---	ns
Q_g	Total Gate Charge	$V_{GS}=10V, V_{DS}=15V,$ $I_D=15A$	---	23.5	---	nC
Q_{gs}	Gate-Source Charge		---	3.3	---	nC
Q_{gd}	Gate-Drain "Miller" Charge		---	4.8	---	nC
Drain-Source Diode Characteristics						
V_{SD}	Source-Drain Diode Forward Voltage ^②	$V_{GS}=0V, I_{SD}=12A$	---	0.81	1.2	V

Trr	Body Diode Reverse Recovery Time	$I_{SD}=10A, V_{GS}=0V$	---	31	---	Ns
Qrr	Body Diode Reverse Recovery Charge	$di/dt=100A/\mu s$	---	20	---	Nc

Notes:

- ① Pulse width limited by maximum allowable junction temperature
- ② Pulse width $\leq 300 \mu s$; duty cycle $\leq 2\%$.

Typical Characteristics: ($T_C=25^\circ C$ unless otherwise noted)

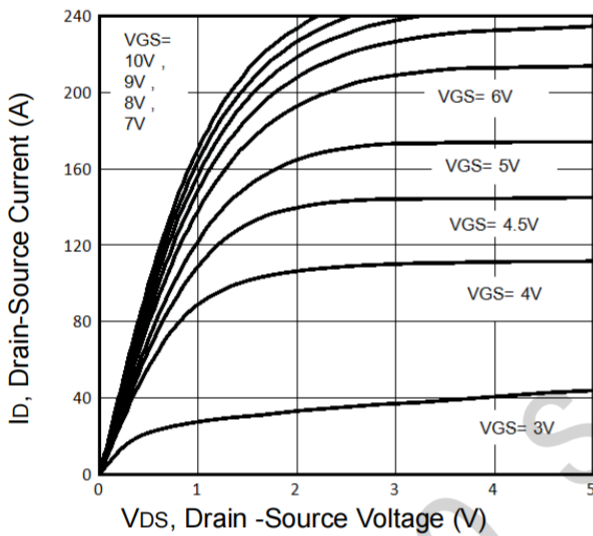

Fig1. Typical Output Characteristics

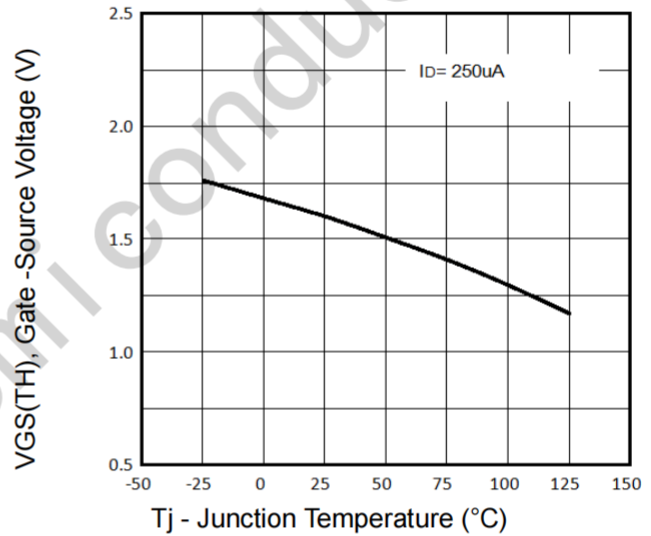

Fig2. VGS(TH) Voltage Vs. Temperature

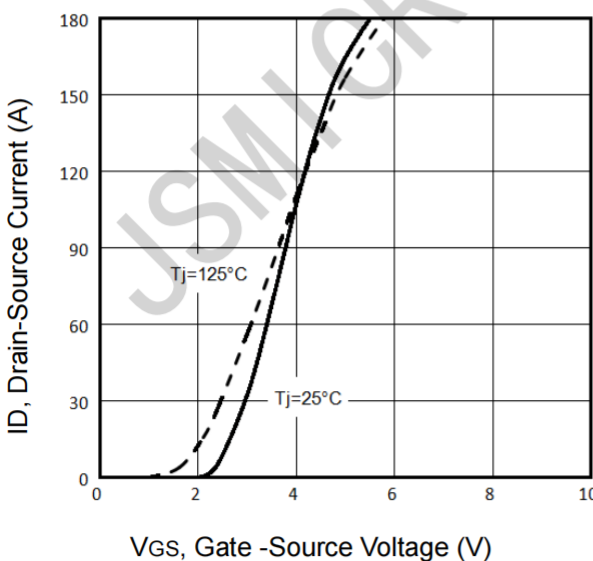

Fig3. Typical Transfer Characteristics

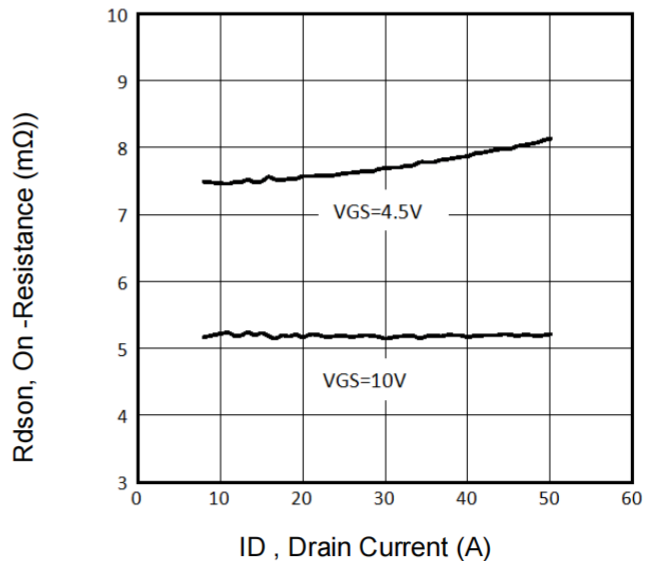

Fig4. On-Resistance vs. Drain Current and Gate Voltage

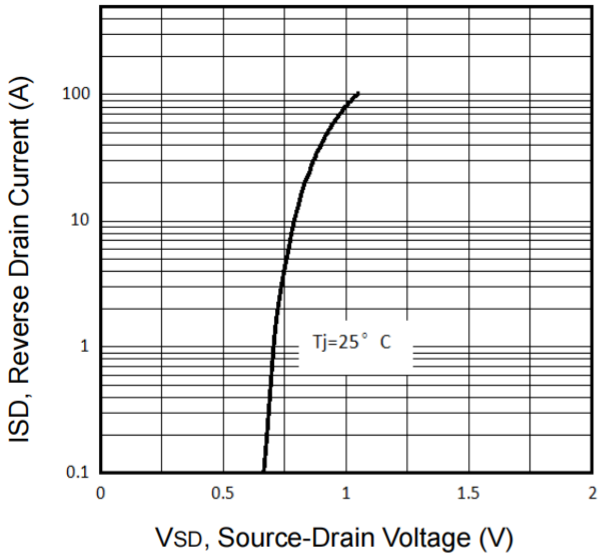

Fig5. Typical Source-Drain Diode Forward Voltage

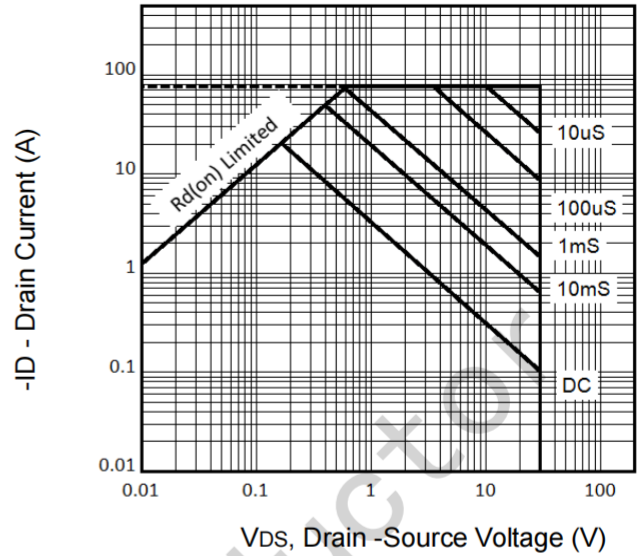

Fig6. Maximum Safe Operating Area

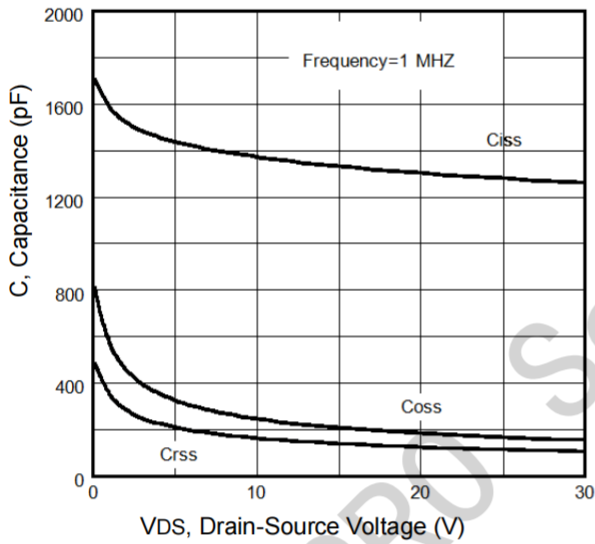

Fig7. Typical Capacitance Vs. Drain-Source Voltage

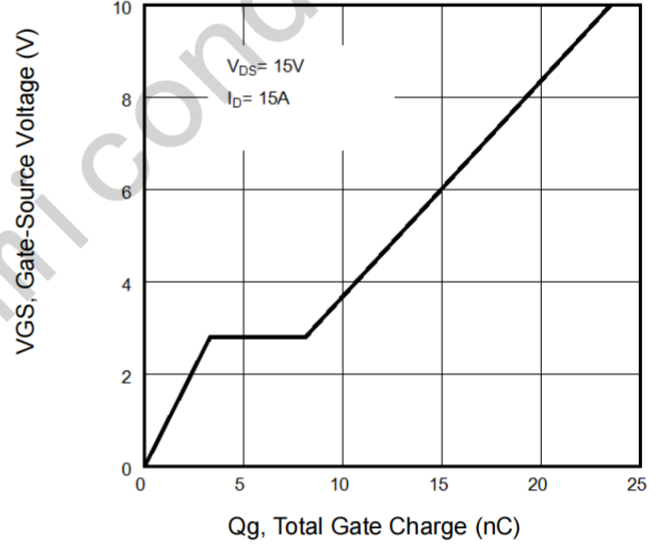

Fig8. Typical Gate Charge Vs. Gate-Source Voltage

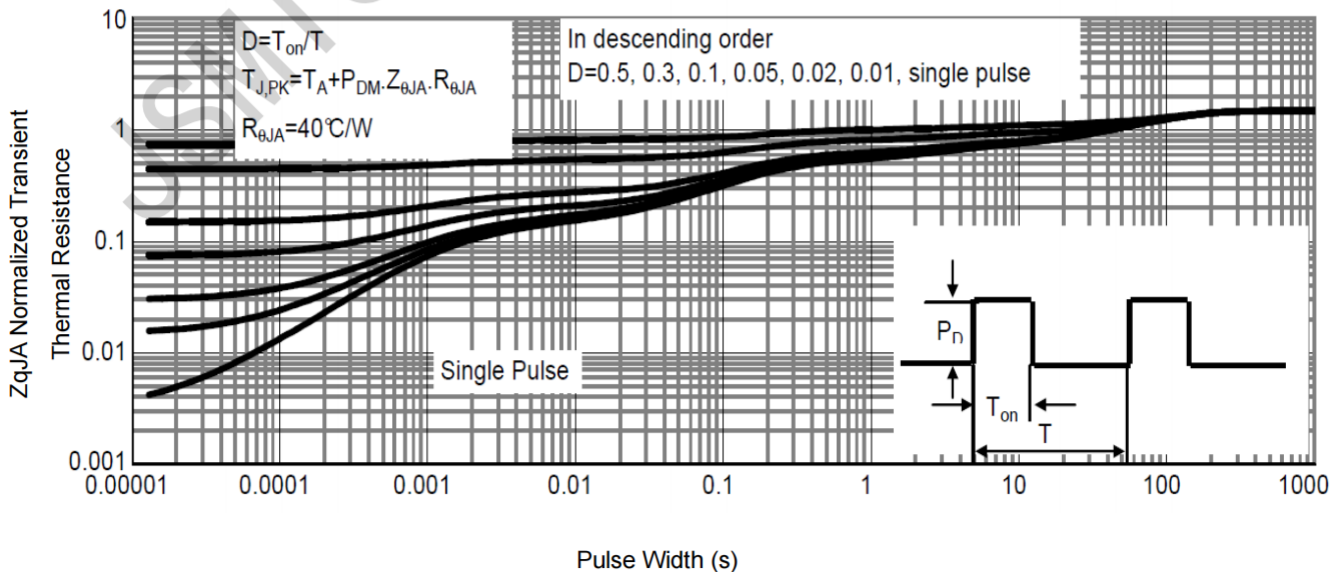
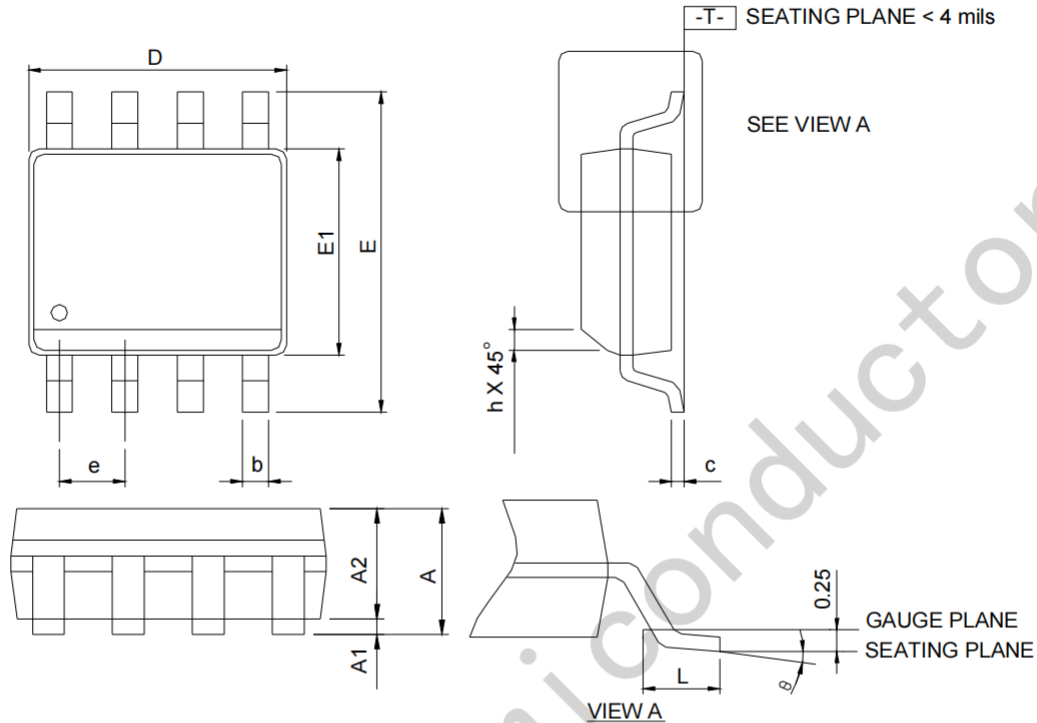

Fig9. Normalized Maximum Transient Thermal Impedance

Package Information

SOP-8



SYMBOLS	SOP-8			
	MILLIMETERS		INCHES	
	MIN.	MAX.	MIN.	MAX.
A	-	1.75	-	0.069
A1	0.10	0.25	0.004	0.010
A2	1.25	-	0.049	-
b	0.31	0.51	0.012	0.020
c	0.17	0.25	0.007	0.010
D	4.80	5.00	0.189	0.197
E	5.80	6.20	0.228	0.244
E1	3.80	4.00	0.150	0.157
e	1.27 BSC		0.050 BSC	
h	0.25	0.50	0.010	0.020
L	0.40	1.27	0.016	0.050
θ	0°	8°	0°	8°

RECOMMENDED LAND PATTERN

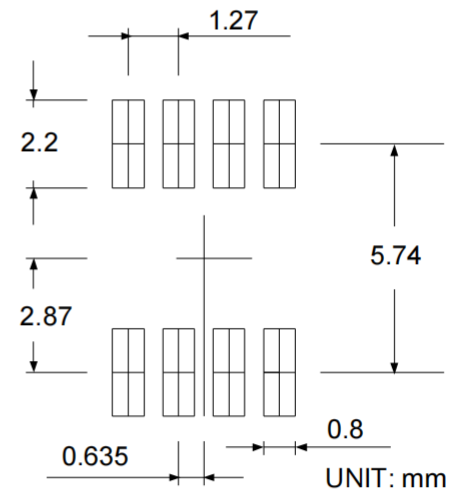

Note: 1. Follow JEDEC MS-012 AA.

2. Dimension "D" does not include mold flash, protrusions or gate burrs. Mold flash, protrusion or gate burrs shall not exceed 6 mil per side.

3. Dimension "E" does not include inter-lead flash or protrusions. Inter-lead flash and protrusions shall not exceed 10 mil per side.