

2177909-1 ✓ ACTIVE

AMP | MCON Interconnection System

TE Internal #: 2177909-1

Automotive Terminals, Receptacle, Mating Tab Width .5 mm [.019 in], Tab Thickness .4 mm [.015 in], 24 – 22 AWG Wire Size, MCON Interconnection System

[View on TE.com >](#)



Terminals & Splices > Automotive Terminals > MCON 0.50 Terminals

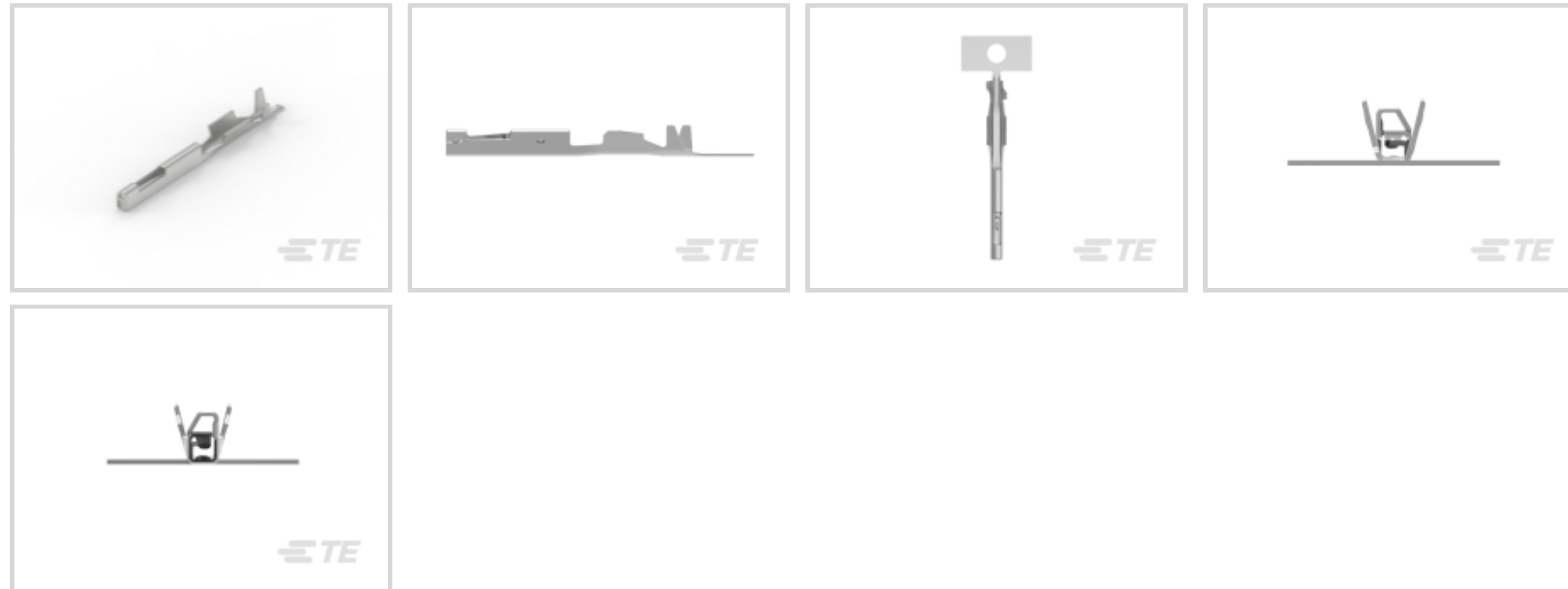

Terminal Type: **Receptacle**

Mating Tab Width: **.5 mm [.019 in]**

Mating Tab Thickness: **.4 mm [.015 in]**

Terminal Transmits: **0 – 24 A (Low Power)**

Wire Size: **24 – 22 AWG**

[All MCON 0.50 Terminals \(4\)](#)

Features

Product Type Features

Receptacle Style	180°
Sealable	No
Primary Locking Feature	Clean Body

Contact Features

Contact Size	1.2mm
Contact Fabrication	Stamped & Formed
Wire Contact Termination Area Plating Material	Tin
Typical Current Rating	3 A
Crimp Type	F-Crimp
Terminal Type	Receptacle
Mating Tab Width	.5 mm [.019 in]
Mating Tab Thickness	.4 mm [.015 in]
Interface Plating	Tin (Sn)



Termination Features

Termination Method to Wire & Cable	Crimp
Product Terminates To	Wire

Dimensions

Compatible Insulation Diameter Range	1.1 – 1.3 mm [.039 – .051 in]
Wire Size	.22 – .35 mm ²
Wire Size Search	22 AWG, 23 AWG, 24 AWG

Usage Conditions

Insulation Option	Uninsulated
Operating Temperature (Max)	80 °C, 85 °C, 90 °C, 100 °C, 105 °C [176 °F] [185 °F][194 °F][212 °F][221 °F]
Operating Temperature Range	-40 – 105 °C [-40 – 221 °F]

Operation/Application

Conforms to KOMAX Automatic Component Insertion Guideline	Yes, per Version 5.0 (March 2018)
Compatible With Wire Base Material	Copper

Industry Standards

Compatible With Agency/Standards Products	LV214
---	-------

Packaging Features

Packaging Quantity	17000
Packaging Method	Reel

Other

Customer Preferred Contact	No
Terminal Transmits	0 – 24 A (Low Power)

Product Compliance

[For compliance documentation, visit the product page on TE.com>](#)

EU RoHS Directive 2011/65/EU	Compliant
EU ELV Directive 2000/53/EC	Compliant
China RoHS 2 Directive MIIT Order No 32, 2016	No Restricted Materials Above Threshold
EU REACH Regulation (EC) No. 1907/2006	Current ECHA Candidate List: JUNE 2023 (235) Candidate List Declared Against: JUNE 2023 (235)



Does not contain REACH SVHC

Halogen Content

Low Halogen - Br, Cl, F, I < 900 ppm per homogenous material. Also BFR/CFR/PVC Free

Solder Process Capability

Not reviewed for solder process capability

Product Compliance Disclaimer

This information is provided based on reasonable inquiry of our suppliers and represents our current actual knowledge based on the information they provided. This information is subject to change. The part numbers that TE has identified as EU RoHS compliant have a maximum concentration of 0.1% by weight in homogenous materials for lead, hexavalent chromium, mercury, PBB, PBDE, DBP, BBP, DEHP, DIBP, and 0.01% for cadmium, or qualify for an exemption to these limits as defined in the Annexes of Directive 2011/65/EU (RoHS2). Finished electrical and electronic equipment products will be CE marked as required by Directive 2011/65/EU. Components may not be CE marked. Additionally, the part numbers that TE has identified as EU ELV compliant have a maximum concentration of 0.1% by weight in homogenous materials for lead, hexavalent chromium, and mercury, and 0.01% for cadmium, or qualify for an exemption to these limits as defined in the Annexes of Directive 2000/53/EC (ELV). Regarding the REACH Regulation, the information TE provides on SVHC in articles for this part number is based on the latest European Chemicals Agency (ECHA) 'Guidance on requirements for substances in articles' posted at this URL: <https://echa.europa.eu/guidance-documents/guidance-on-reach>

Compatible Parts



TE Part # 1801823-3
4POS,MCON 0.5 CB,REC HSG,BLUE, ASSY,SLD

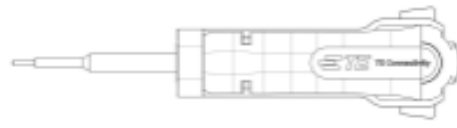

TE Part # 2-1579028-6
EXTRACTION TOOL



TE Part # 2-1579028-8
EXTRACTION TOOL



TE Part # 2151523-2
OCEAN_2.0_APPLICATOR-S-042F042O



TE Part # 2151524-2
OCEAN_2.0_APPLICATOR-S-042F050O



TE Part # 2266703-2
OCEAN_2.0_APPLICATOR-S-042F050O



TE Part # 2305570-1
Strip Terminal Cutter-Side Feed-No Crimp



TE Part # 2836544-2
OCEAN_2.0_APPLICATOR-S-042F042O



TE Part # 2836545-2
OCEAN_2.0_APPLICATOR-S-042F050O



TE Part # 5-2836545-2
OCEAN_2.0_APPLICATOR-S-042F050O



TE Part # 7-2151523-7
OCEAN_2.0_SPARE_PART_KIT-042F042O



TE Part # 7-2151524-7
OCEAN_2.0_SPARE_PART_KIT-042F050O



KIT

REPRESENTATION ONLY

TE Part # 7-2266278-7
OC-042F050O-CRIMPTOOLINGKIT



TE Part # 7-2836544-2
OCEAN_2.0_APPLICATOR-S-042F042O



KIT

REPRESENTATION ONLY

TE Part # 7-2836544-7
OCEAN_2.0_SPARE_PART_KIT-042F042O



TE Part # 7-2836545-2
OCEAN_2.0_APPLICATOR-S-042F050O



KIT

REPRESENTATION ONLY

TE Part # 7-2836545-7
OCEAN_2.0_SPARE_PART_KIT-042F050O



REPRESENTATION ONLY. DIE SET MAY VARY.

TE Part # 2380840-1
SDE F MCON 050 0.13-0.22mm2 ASSY



REPRESENTATION ONLY. DIE SET MAY VARY.

TE Part # 2380841-1
SDE F MCON 050 0.22-0.35mm2 ASSY



TE Part # 2380840-2
SDE F MCON 050 0.13-0.22mm2 DIE SET

Also in the Series | MCON Interconnection System



Automotive Connector Caps & Covers (21)

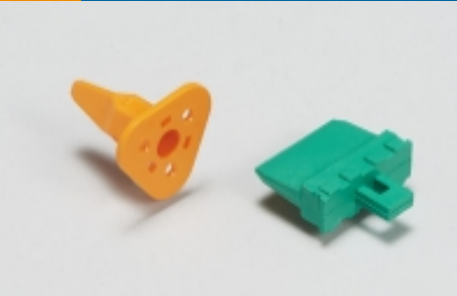

Automotive Connector Locks & Position Assurance(11)



Automotive Housings(288)



Automotive Terminals(119)



Connector Seals & Cavity Plugs(11)



Insertion & Extraction Tools(31)



Other Automotive Connector Accessories(2)



PCB Headers & Receptacles(2)

Customers Also Bought



TE Part #1379659-4
TH/.025 CONNECTOR SYSTEM, HOUSING



TE Part #1801616-1
FUSES HOLDER 10 MINIFUSES

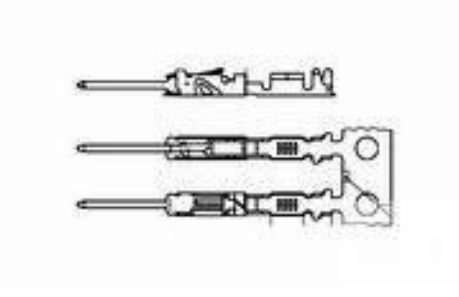

TE Part #1411582-2
STIFTKONT M5300Y60



TE Part #1-1534121-2
MQS ABDECKKAP6P, BR

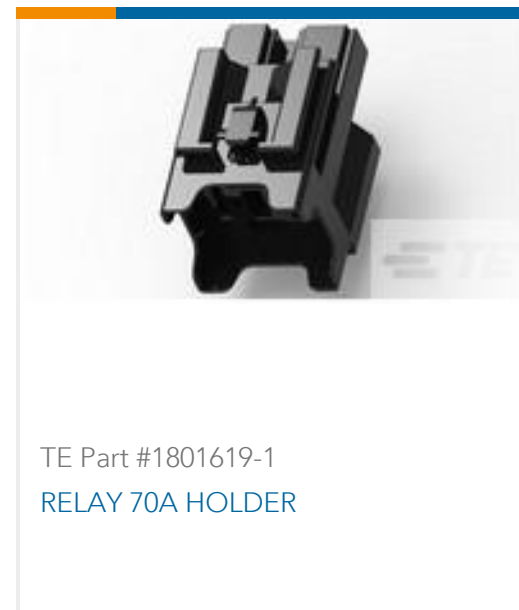
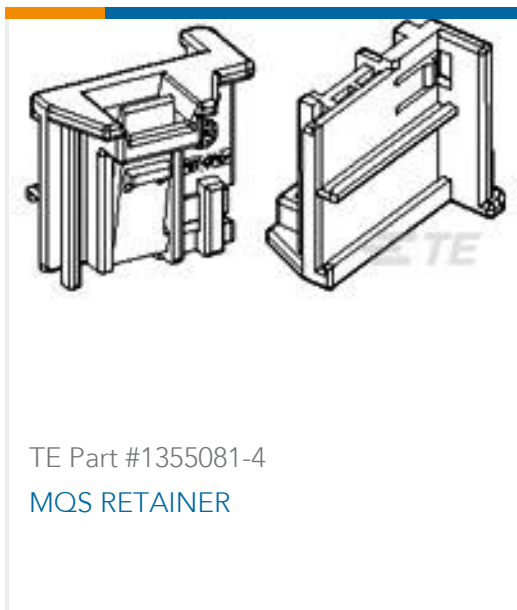

Documents

Product Drawings

MCON 0.50 TERMINAL

English

MCON 0.50 TERMINAL

English

CAD Files

3D PDF

3D

Customer View Model

[ENG_CVM_CVM_2177909-1_A.2d_dxf.zip](#)

English

Customer View Model

[ENG_CVM_CVM_2177909-1_A.3d_igs.zip](#)

English

Customer View Model

[ENG_CVM_CVM_2177909-1_A.3d_stp.zip](#)

English

By downloading the CAD file I accept and agree to the [Terms and Conditions](#) of use.

Datasheets & Catalog Pages

MCON Interconnection System

English

Product Specifications

Application Specification

English



[Agency Approvals](#)

[CSA Certificate](#)

English