

REV. (版本号)	DESCRIPTION (变更说明)	DATE (日期)	APPD (核准)

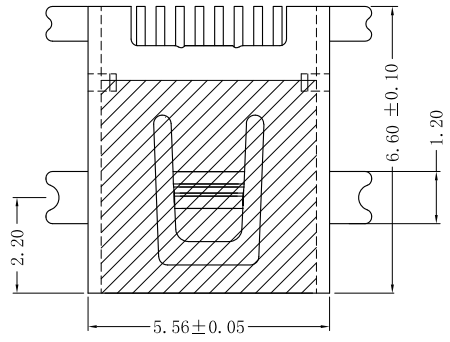

8 PIN MINI USB PIN ASSIGNMENTS

PIN NUMBER	SIGNAL NAME
1	GND
2	TV
3	AUDIO
4	TV_DET
5	D+
6	GND
7	D-
8	VBUS

规格说明:Specifications:

电气特性:Electrical:

1. 额定电流: Current Rating
1.0A/contact terminal
2. 额定电压: Voltage Rating
30V DC
3. 接触阻抗: Contact Resistance
50 milliohms MAX
4. 耐电压: Dielectric Withstanding Voltage:
300 V AC AT Sea Level
5. 绝缘阻抗: Insulation Resistance:
100MEGA ohms MIN

原材料:Raw material:

1. 塑胶: Plastic cement:
Hing Temperature Thermoplastics,
LCP Black
2. 端子: Contact: Copper Alloy C5191
3. 外壳: Shell: Copper Alloy C2680

电镀: Electroplate:

1. 端子: Contact: Plated Gold in Mating Area;
Tin On Solder Talls
2. 外壳: Shell:
Nickel Plating

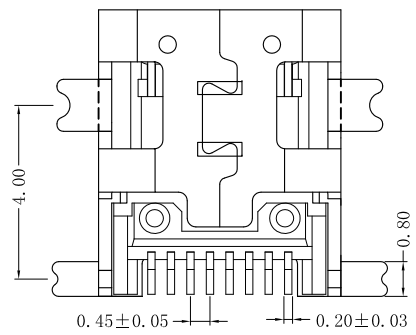
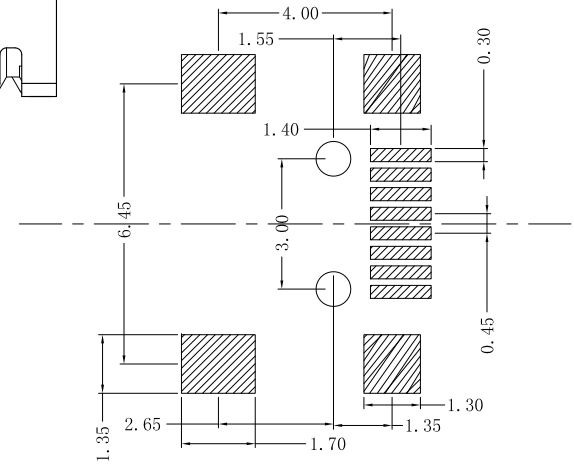
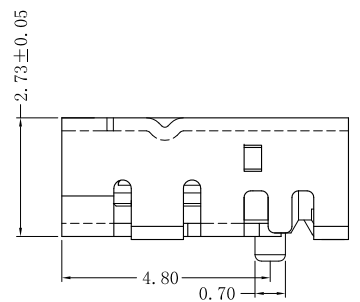
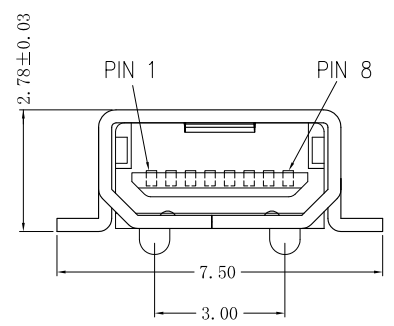

1D外壳

 深圳市宇文发电子科技有限公司 Shen Zhen Yu Wen Fa Electronics Technology Co., Ltd TEL: 0755-27711235 FAX: 0755-27712683	页码 (SHEET)	1/1	单位 (UNIT): MM										
	版本 (REV)	A0	比例 (SCALE) 1:1										
品名 (ITEM NO)	MINI USB 8P/F SMT四脚(模顶/双边倒角)	日期 (DATE)	2013.12.6										
料号 (PART NO)	PU8FW-R21C-012	设计 (DESIGN)	朱汝健										
图号 (DWG NO)	P-U8F-012	审核 (CHECKED)	未注公差 TOLERANCE UNSPECIFIED										
		核准 (APPROVED)	<table border="0"> <tr><td>X.X</td><td>±0.30</td></tr> <tr><td>X.XX</td><td>±0.20</td></tr> <tr><td>X.XXX</td><td>±0.10</td></tr> <tr><td>X°</td><td>±5°</td></tr> <tr><td>X.X°</td><td>±2°</td></tr> </table>	X.X	±0.30	X.XX	±0.20	X.XXX	±0.10	X°	±5°	X.X°	±2°
X.X	±0.30												
X.XX	±0.20												
X.XXX	±0.10												
X°	±5°												
X.X°	±2°												

RoHS Compliant

REV.	ECN NO	DESCRIPTION	REVISER	DATE
A/0				
A/1				

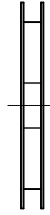

① 胶盘

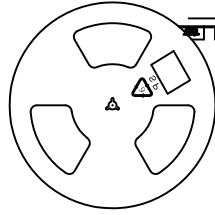
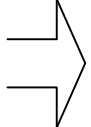

② 1000pcs/盘



产品

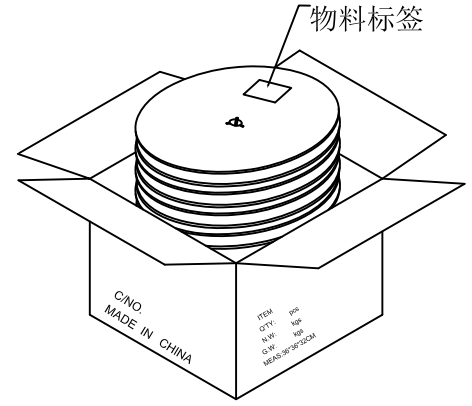
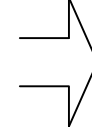

③ 10盘/箱 (10 Kpcs)

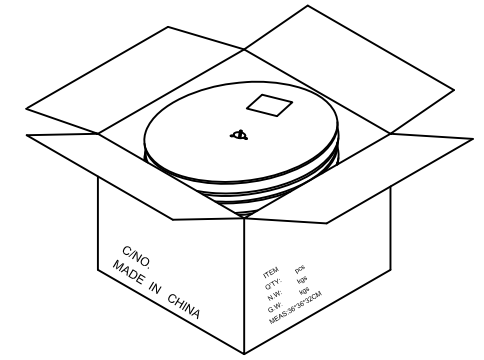

④ 每箱装10盘, 若尾数箱在空间处加装填充物.

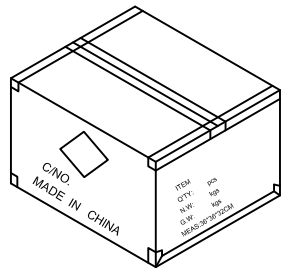
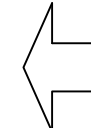

⑤ 外箱用透明胶纸带封"工"字型.

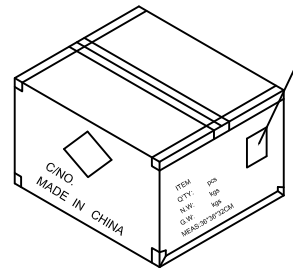
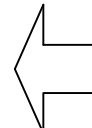

⑥ 依图示粘贴产品或ROHS标签.

备注:

1. 胶盘规格: 330*20mm
2. 每盘装1.0K pcs;
3. 每箱装10盘 (10K pcs);
4. 外箱尺寸:长*宽*高:34*34*23cm; 材质A=B
5. 外箱用透明胶纸带封"工"字型;
6. 依外箱图示位置粘贴好产品或ROHS标签.

图号 (DWG NO)		单位 (UNIT): MM	深圳宇文发电子科技有限公司 TEL:0755-27711235 FAX:0755-27712683	
日期 (DATE)	2011.05.17	比例 (SCALE) 1:1		
版次 (REV): A/0	页/次(PAGE): 1/1		品名 (ITEM NO) MINI USB 8P/F SMT四脚 系列 料号 (PART NO)	
设计 (DESIGN)	李丰桔	包装规范		
审核 (CHECKED)				
核准 (APPROVED)				