

**技术特性/Specifications:**

额定电压 Rated voltage: 250V AC, DC  
额定电流 Rated current: 3A AC, DC  
接触电阻 Contact resistance: 20m $\Omega$  max  
绝缘电阻 Insulation resistance: 1000M $\Omega$  min  
耐压 Withstand voltage: 800V AC/minute  
环境温度 Ambient temperature: -40 $^{\circ}$ C~+105 $^{\circ}$ C  
适用线规 Wire range: AWG#28~#22

REV.	REVISION DESCRIPTION	DATE	APPD

16PIN以上

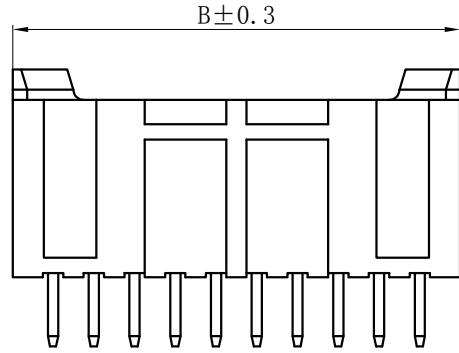

14PIN以下

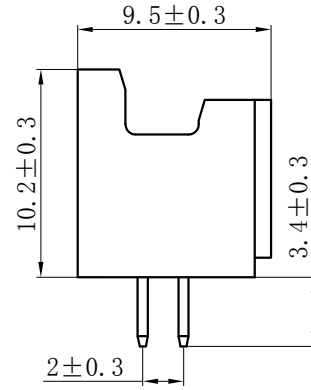
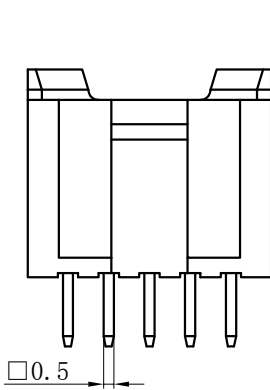

## NOTES

Available in 04 through 40 Circuits.  
 Mates with DL20034-Y Series Housing.  
 Material : Nylon UL94V-0 (2) .  
 0.50mm Square Pin.  
 Pin Material : Brass / Tin-Plated.

30-40PIN

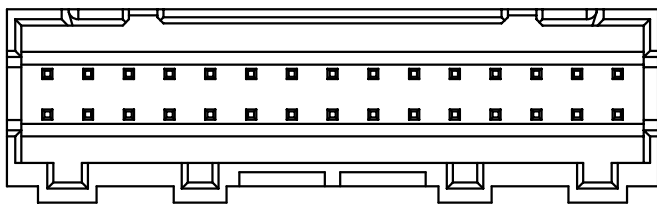

10-28PIN

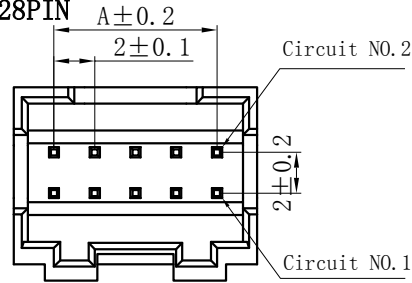

4-8PIN

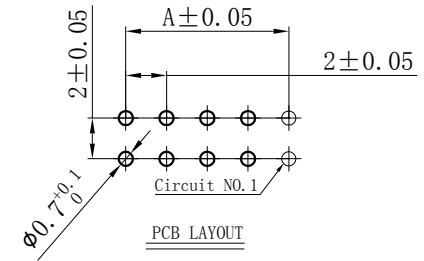
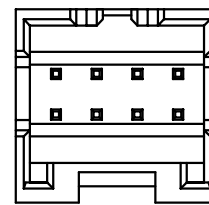

Circuits	Type	Dimensino(mm)		Circuits	Type	Dimensino(mm)	
		A	B			A	B
2X2	PAD-4A	2.00	6.00	2X12	PAD-24A	22.00	26.00
2X3	PAD-6A	4.00	8.00	2X13	PAD-26A	24.00	28.00
2X4	PAD-8A	6.00	10.00	2X14	PAD-28A	26.00	30.00
2X5	PAD-10A	8.00	12.00	2X15	PAD-30A	28.00	32.00
2X6	PAD-12A	10.00	14.00	2X16	PAD-32A	30.00	34.00
2X7	PAD-14A	12.00	16.00	2X17	PAD-34A	32.00	36.00
2X8	PAD-16A	14.00	18.00	2X18	PAD-36A	34.00	38.00
2X9	PAD-18A	16.00	20.00	2X19	PAD-38A	36.00	40.00
2X10	PAD-20A	18.00	22.00	2X20	PAD-40A	38.00	42.00
2X11	PAD-22A	20.00	24.00				

GENERAL TOLERANCES (UNLESS SPECIFIED)		ZHE JIANG DELI CONNECTORS CO., LTD	
.X: ± 0.25	X° : ± 3.0°	PRODUCT NAME:	TITLE: 2.00 mm Pitch
.XX: ± 0.15	.X° : ± 2.0°	DL20034-A (PAD-A)	Wire To Board Wafer
.XXX: ± 0.01	.XX° : ± 1.0°	DR: Chen Quan Long	DATE:22/12/01
FINISH:		CHKD: Wu Hui	DATE:22/12/01
DRAWING NO:		APPD:Ren An De	DATE:22/12/01
			PART NO:
			SCALE: N/A
			PAGE: 1/1
			UNITS: mm
			REV.: A

REV.	REVISION DESCRIPTION	DATE	APPD

### NOTES

Available in 04 through 40 Circuits.  
 Mates with DL20034-Y Series Housing.  
 Material : Nylon UL94V-0 (2) .  
 0.50mm Square Pin.  
 Pin Material : Brass / Tin-Plated.

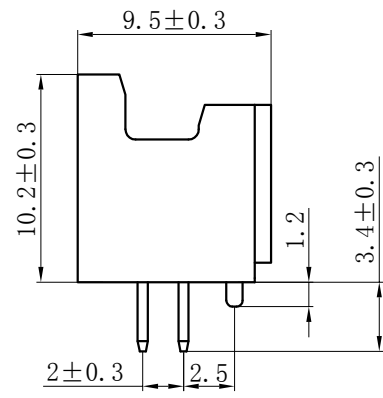
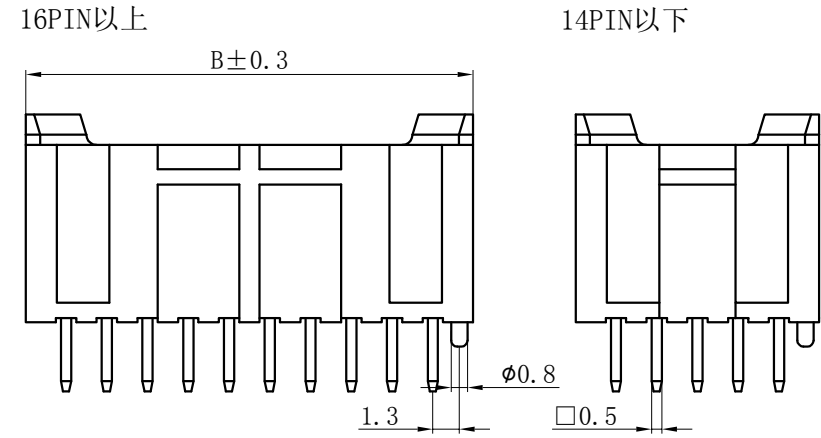

30-40PIN

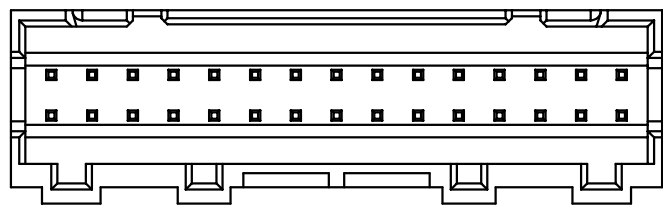

10-28PIN

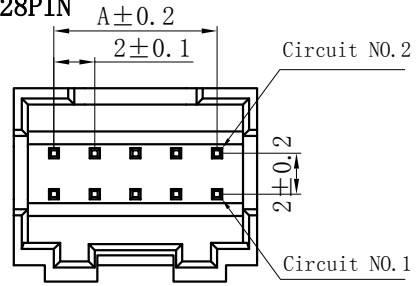

4-8PIN

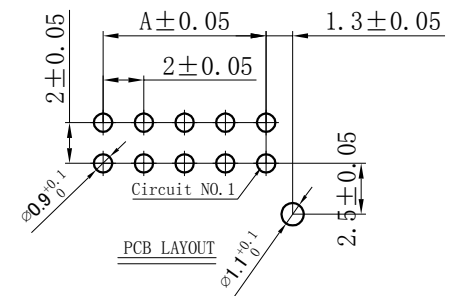
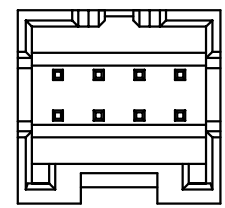

Circuits	Type	Dimensino (mm)		Circuits	Type	Dimensino (mm)	
		A	B			A	B
2X2	PAD-4AS	2.00	6.00	2X12	PAD-24AS	22.00	26.00
2X3	PAD-6AS	4.00	8.00	2X13	PAD-26AS	24.00	28.00
2X4	PAD-8AS	6.00	10.00	2X14	PAD-28AS	26.00	30.00
2X5	PAD-10AS	8.00	12.00	2X15	PAD-30AS	28.00	32.00
2X6	PAD-12AS	10.00	14.00	2X16	PAD-32AS	30.00	34.00
2X7	PAD-14AS	12.00	16.00	2X17	PAD-34AS	32.00	36.00
2X8	PAD-16AS	14.00	18.00	2X18	PAD-36AS	34.00	38.00
2X9	PAD-18AS	16.00	20.00	2X19	PAD-38AS	36.00	40.00
2X10	PAD-20AS	18.00	22.00	2X20	PAD-40AS	38.00	42.00
2X11	PAD-22AS	20.00	24.00				

GENERAL TOLERANCES (UNLESS SPECIFIED)		ZHE JIANG DELI CONNECTORS CO., LTD	
.X: ± 0.25	X° : ± 3.0°	PRODUCT NAME:	TITLE: 2.00 mm Pitch Wire To Board Wafer
.XX: ± 0.15	.X° : ± 2.0°	DL20034-AS (PAD-AS)	
.XXX: ± 0.01	.XX° : ± 1.0°	DR: Chen Quan Long	DATE:22/12/01
FINISH:		CHKD: Wu Hui	DATE:22/12/01
DRAWING NO:		APPD:Ren An De	DATE:22/12/01
			SCALE: N/A
			PAGE: 1/1
			UNITS: mm
			REV.: A

REV.	REVISION DESCRIPTION	DATE	APPD

16PIN以上

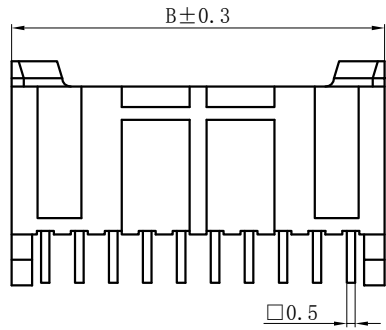

14PIN以下

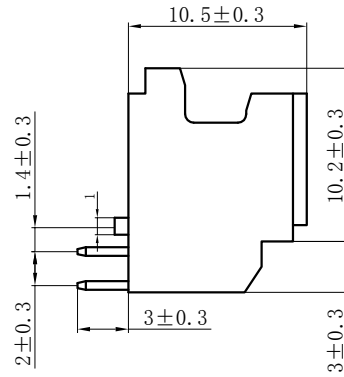
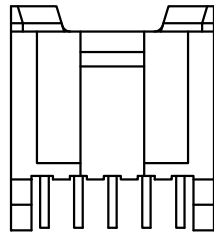

## NOTES

Available in 04 through 40 Circuits.  
 Mates with DL20034-Y Series Housing.  
 Material : Nylon UL94V-0 (2) .  
 0.50mm Square Pin.  
 Pin Material : Brass / Tin-Plated.

30-40PIN

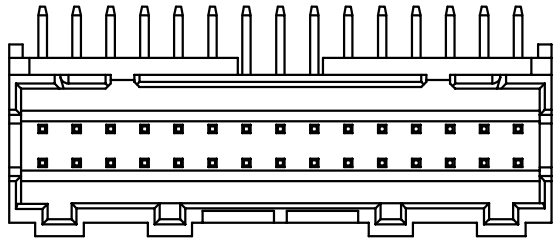

10-28PIN

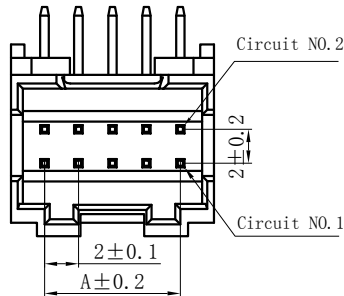

4-8PIN

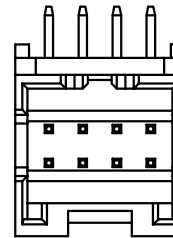

Circuits	Type	Dimensino (mm)		Circuits	Type	Dimensino (mm)	
		A	B			A	B
2X2	PAD-4AWD-S	2.00	6.00	2X12	PAD-24AWD-S	22.00	26.00
2X3	PAD-6AWD-S	4.00	8.00	2X13	PAD-26AWD-S	24.00	28.00
2X4	PAD-8AWD-S	6.00	10.00	2X14	PAD-28AWD-S	26.00	30.00
2X5	PAD-10AWD-S	8.00	12.00	2X15	PAD-30AWD-S	28.00	32.00
2X6	PAD-12AWD-S	10.00	14.00	2X16	PAD-32AWD-S	30.00	34.00
2X7	PAD-14AWD-S	12.00	16.00	2X17	PAD-34AWD-S	32.00	36.00
2X8	PAD-16AWD-S	14.00	18.00	2X18	PAD-36AWD-S	34.00	38.00
2X9	PAD-18AWD-S	16.00	20.00	2X19	PAD-38AWD-S	36.00	40.00
2X10	PAD-20AWD-S	18.00	22.00	2X20	PAD-40AWD-S	38.00	42.00
2X11	PAD-22AWD-S	20.00	24.00				

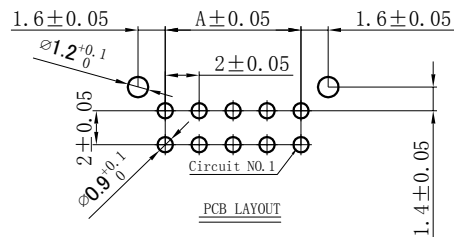

GENERAL TOLERANCES (UNLESS SPECIFIED)		ZHE JIANG DELI CONNECTORS CO., LTD	
.X: ± 0.25	X° : ± 3.0°	PRODUCT NAME:	TITLE: 2.00 mm Pitch
.XX: ± 0.15	.X° : ± 2.0°	DL20034-AWD-S (PAD-AWD-S)	Wire To Board Wafer
.XXX: ± 0.01	.XX° : ± 1.0°	DR: Chen Quan Long	DATE:22/12/01
FINISH:		CHKD: Wu Hui	DATE:22/12/01
DRAWING NO:		APPD:Ren An De	DATE:22/12/01
			SCALE: N/A
			PAGE: 1/1
			UNITS: mm
			REV.: A

REV.	REVISION DESCRIPTION	DATE	APPD

### NOTES

Available in 04 through 40 Circuits.  
 Match with DL20034 series Wafer.  
 Material : Nylon UL94V-0.  
 Accepts DL20034-T Crimp Terminal.

16PIN以上

14PIN以下

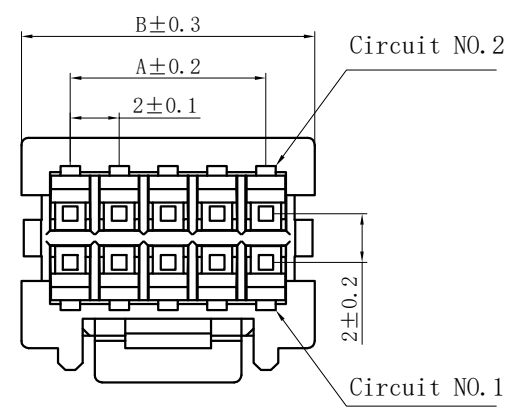
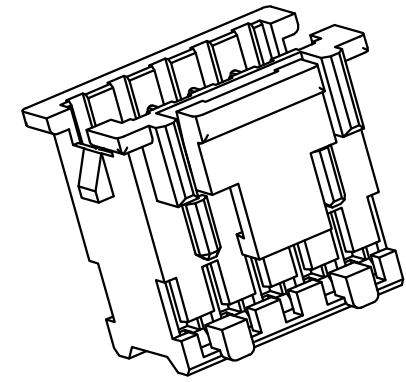
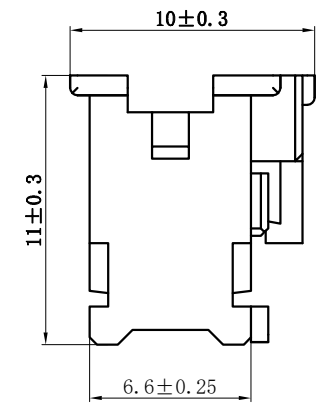
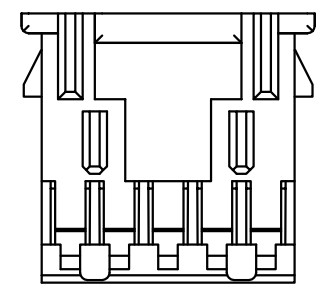
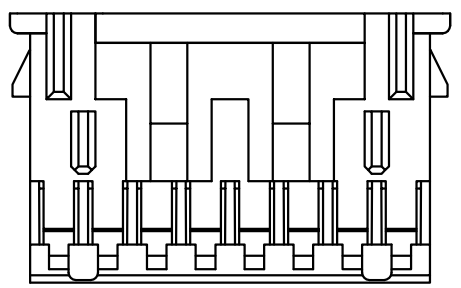

Circuits	Product name	Dimensino(mm)		Circuits	Product name	Dimensino(mm)	
		A	B			A	B
2X2	PAD-4Y-G8-750	2.00	6.00	2X12	PAD-24Y-G8-750	22.00	26.00
2X3	PAD-6Y-G8-750	4.00	8.00	2X13	PAD-26Y-G8-750	24.00	28.00
2X4	PAD-8Y-G8-750	6.00	10.00	2X14	PAD-28Y-G8-750	26.00	30.00
2X5	PAD-10Y-G8-750	8.00	12.00	2X15	PAD-30Y-G8-750	28.00	32.00
2X6	PAD-12Y-G8-750	10.00	14.00	2X16	PAD-32Y-G8-750	30.00	34.00
2X7	PAD-14Y-G8-750	12.00	16.00	2X17	PAD-34Y-G8-750	32.00	36.00
2X8	PAD-16Y-G8-750	14.00	18.00	2X18	PAD-36Y-G8-750	34.00	38.00
2X9	PAD-18Y-G8-750	16.00	20.00	2X19	PAD-38Y-G8-750	36.00	40.00
2X10	PAD-20Y-G8-750	18.00	22.00	2X20	PAD-40Y-G8-750	38.00	42.00
2X11	PAD-22Y-G8-750	20.00	24.00				

GENERAL TOLERANCES (UNLESS SPECIFIED)		ZHE JIANG DELI CONNECTORS CO.,LTD	
.X: ± 0.25	X° : ± 3.0°	PRODUCT NAME:	TITLE:
.XX: ± 0.15	.X° : ± 2.0°	DL20034-Y-G8-750 (PAD-Y-G8-750)	2.00 mm Pitch Housing
.XXX: ± 0.01	.XX° : ± 1.0°	DR: Chen Quan Long	DATE:22/12/01
FINISH:		CHKD:Wu Hui	DATE:22/12/01
DRAWING NO:		APPD:Ren An De	DATE:22/12/01
		SCALE: N/A	PAGE: 1/1
		UNITS: mm	REV.: A

REV.	REVISION	DESCRIPTION	DATE	APPD

### NOTES

Available in 04 through 40 Circuits.  
Mates with PAD-Y Series Housing.  
Material : Nylon UL94V-0(2).  
Green Material RoHS Compliant.  
Accepts PAD-H-T Crimp Terminal.

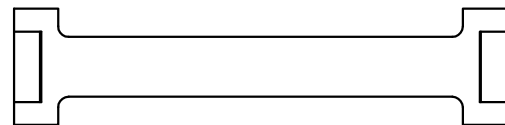
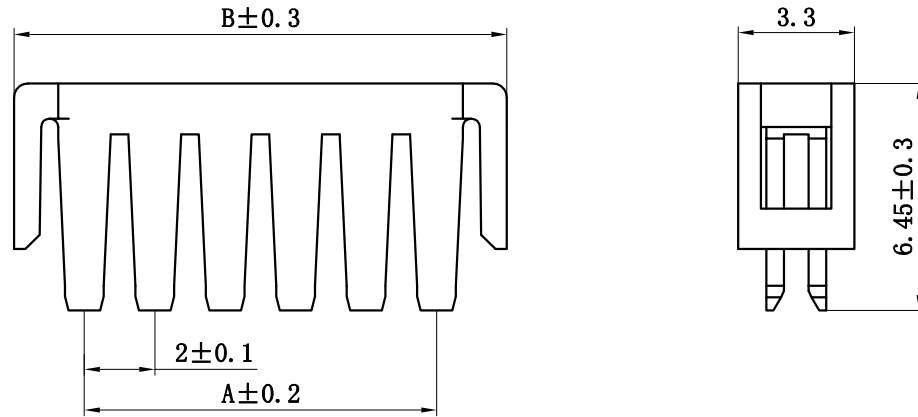

Circuits	Type	Dimension (mm)		Circuits	Type	Dimension (mm)	
		A	B			A	B
2X2	PAD-4S-DJ	2.00	6.00	2X12	PAD-24S-DJ	22.00	26.00
2X3	PAD-6S-DJ	4.00	8.00	2X13	PAD-26S-DJ	24.00	28.00
2X4	PAD-8S-DJ	6.00	10.00	2X14	PAD-28S-DJ	26.00	30.00
2X5	PAD-10S-DJ	8.00	12.00	2X15	PAD-30S-DJ	28.00	32.00
2X6	PAD-12S-DJ	10.00	14.00	2X16	PAD-32S-DJ	30.00	34.00
2X7	PAD-14S-DJ	12.00	16.00	2X17	PAD-34S-DJ	32.00	36.00
2X8	PAD-16S-DJ	14.00	18.00	2X18	PAD-36S-DJ	34.00	38.00
2X9	PAD-18S-DJ	16.00	20.00	2X19	PAD-38S-DJ	36.00	40.00
2X10	PAD-20S-DJ	18.00	22.00	2X20	PAD-40S-DJ	38.00	42.00
2X11	PAD-22S-DJ	20.00	24.00				

GENERAL TOLERANCES (UNLESS SPECIFIED)		ZHE JIANG DELI CONNECTORS CO., LTD			
.X: ± 0.25	X°: ± 3.0°	PRODUCT NAME: <b>DL20034-S-DJ (PAD-S-DJ)</b>		TITLE: 2.0 mm Pitch Wire To Board	
.XX: ± 0.15	.X°: ± 2.0°	DR: Chen Quan Long	DATE: 19/08/01	PART NO:	
.XXX: ± 0.01	.XX°: ± 1.0°	CHKD: Wu Hui	DATE: 19/08/01	SCALE: N/A	PAGE: 1/1
DRAWING NO:		APPD: Ren An De	DATE: 19/08/01	UNITS: mm	REV.: A

REV.	REVISION DESCRIPTION	DATE	APPD

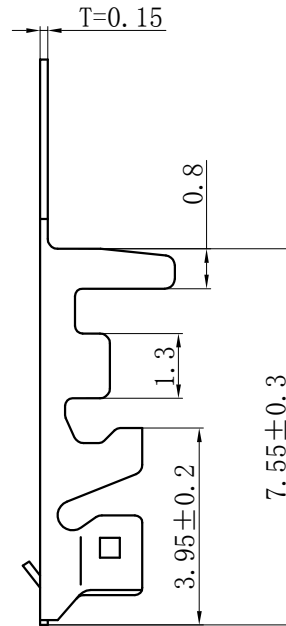
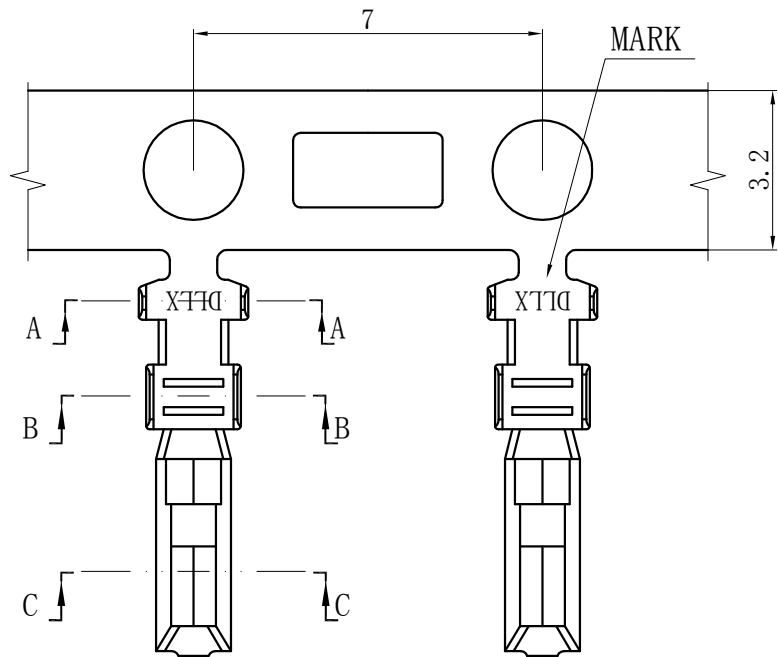

## NOTES

Used in DL20034-Y Series Housing.  
 Accepts AWG #28~22 Wire Range.  
 0.08~ 0.33 mm<sup>2</sup> .  
 Insulation O.D.=0.8~1.5 mm.  
 Material : Phosphor Bronze .  
 Finish: Tin plated.  
 Thickness: 0.15 mm.  
 Plug-in force: Loose fit.

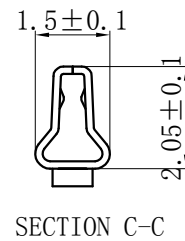
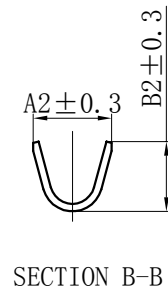
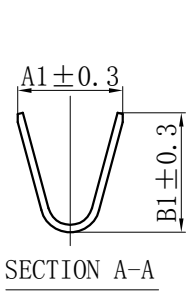

Product name	Dimension mm				适用线规 AWG#
	A1	B1	A2	B2	
PAD-H-T	2.2	2.7	1.8	1.4	24-22
PAD-H-T-D	2.2	2.4	1.6	1.4	28-24

GENERAL TOLERANCES (UNLESS SPECIFIED)		ZHE JIANG DELI CONNECTORS CO., LTD	
.X: ± 0.25	X°: ± 3.0°	PRODUCT NAME:	TITLE: 2.00 mm Pitch Crimp Terminal
.XX: ± 0.15	.X°: ± 2.0°	DL20034-T (PAD-H-T)	
.XXX: ± 0.01	.XX°: ± 1.0°	DR: Chen Quan Long	DATE: 20/01/26
FINISH:		CHKD: Wu Hui	DATE: 20/01/26
DRAWING NO:	APPD: Ren An De	DATE: 20/01/26	SCALE: N/A
			PAGE: 1/1
			UNITS: mm
			REV.: A