

REV. (版本号)	DESCRIPTION (变更说明)	DATE (日期)	APPD (核准)
A1	③ 3.85±0.05 变更为 3.80±0.10	2018.04.28	朱汝健

8 PIN MINI USB PIN ASSIGNMENTS

PIN NUMBER	SIGNAL NAME
1	GND
2	TV
3	AUDIO
4	TV_DET
5	D+
6	GND
7	D-
8	VBUS

规格说明: Specifications:

电气特性: Electrical:

- 额定电流: Current Rating
1.0A/contact terminal
- 额定电压: Voltage Rating
30V DC
- 接触阻抗: Contact Resistance
50 milliohms MAX
- 耐电压: Dielectric Withstanding Voltage:
300 V AC AT Sea Level
- 绝缘阻抗: Insulation Resistance:
100MEGA ohms MIN

原材料: Raw material:

- 塑胶: Plastic cement:
Hing Temperature Thermoplastics,
LCP Black
- 端子: Contact: Copper Alloy C5191
- 外壳: Shell: Copper Alloy C2680

电镀: Electroplate:

- 端子: Contact: Plated Gold in Mating Area;
Tin On Solder Talls
- 外壳: Shell:
Nickel Plating

麦拉片

1H外壳

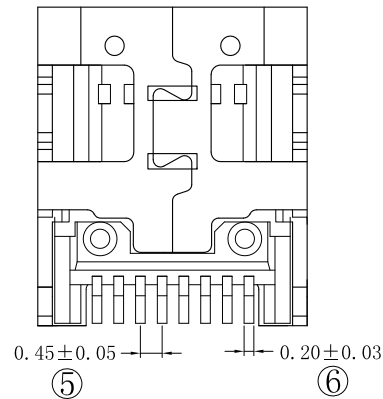
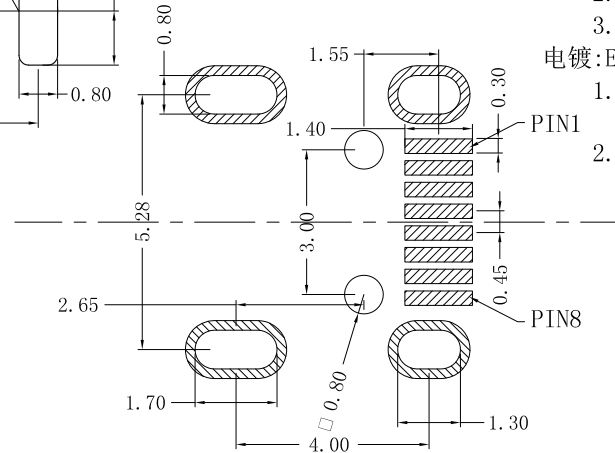
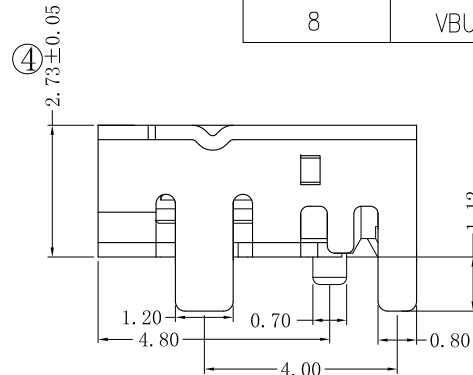
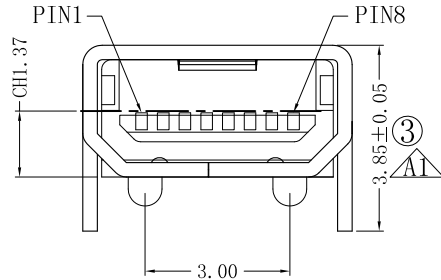
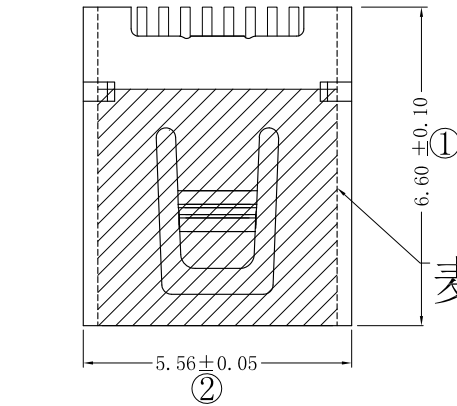

 深圳市宇文发电子科技有限公司 Shen Zhen Yu Wen Fa Electronics Technology Co., Ltd TEL: 0755-27711235 FAX: 0755-27712683	页码 (SHEET)	1/1	单位 (UNIT): MM
	版本 (REV)	A1	比例 (SCALE) 1:1
	日期 (DATE)	2013.12.6	
	设计 (DESIGN)	朱汝健	未注公差 TOLERANCE UNSPECIFIED
	图号 (DWG NO)	P-U8F-011	X.X ±0.30 X.XX ±0.20 X.XXX ±0.10 X° ±5° X.X° ±2°
品名 (ITEM NO)	MINI USB 8P/F DIP90° 四脚(模顶/双边倒角)		审核 (CHECKED)
料号 (PART NO)	PU8FW-R22C-008		核准 (APPROVED)

RoHS Compliant

REV.	ECN NO	DESCRIPTION	REVISER	DATE
A/0				
A/1				

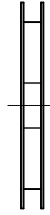

① 胶盘

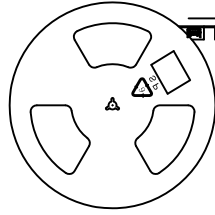
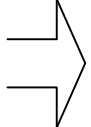

② 1000pcs/盘

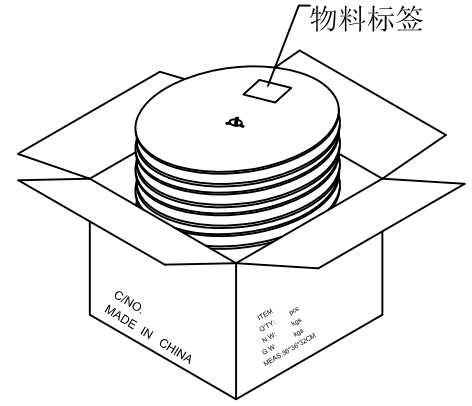
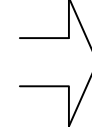
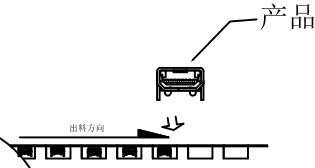

③ 10盘/箱 (10 Kpcs)

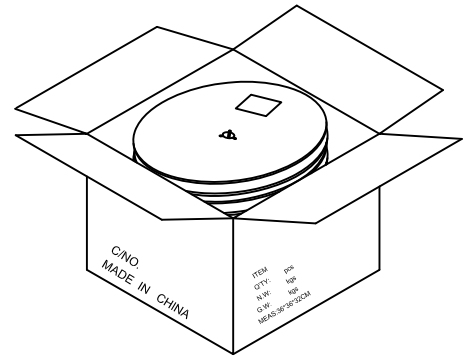
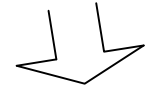

④ 每箱装10盘, 若尾数箱在空间处加装填充物.

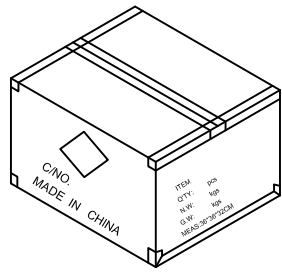
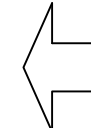

⑤ 外箱用透明胶纸带封"工"字型.

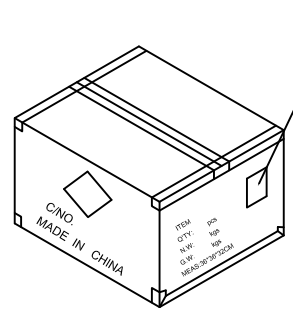
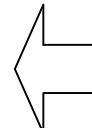

⑥ 依图示粘贴产品或ROHS标签.

- 备注:
1. 胶盘规格: 330*20mm
 2. 每盘装1.0K pcs;
 3. 每箱装10盘 (10K pcs);
 4. 外箱尺寸:长*宽*高:34*34*23cm; 材质A=B
 5. 外箱用透明胶纸带封"工"字型;
 6. 依外箱图示位置粘贴好产品或ROHS标签.

图号 (DWG NO)		单位 (UNIT): MM	深圳宇文发电子科技有限公司 TEL:0755-27711235 FAX:0755-27712683	
日期 (DATE)	2011.05.17	比例 (SCALE) 1:1		
版次 (REV): A/0	页/次(PAGE): 1/1			
设计 (DESIGN)	李丰桔	包装规范	品名 (ITEM NO)	MINI USB 8P/F 系列
审核 (CHECKED)			料号 (PART NO)	
核准 (APPROVED)				