

REV	DESCRIPTION OF CHANGE	REVIEWED BY	ISSUE DATE
A	FIRST ISSUE	X.YAN	2021-08-01

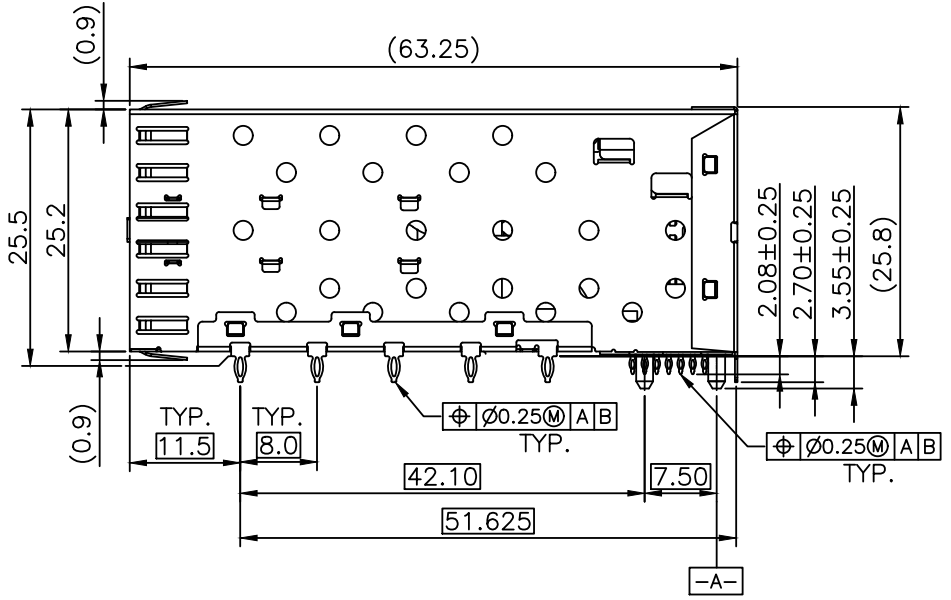
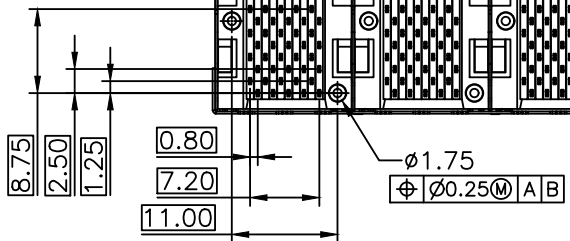
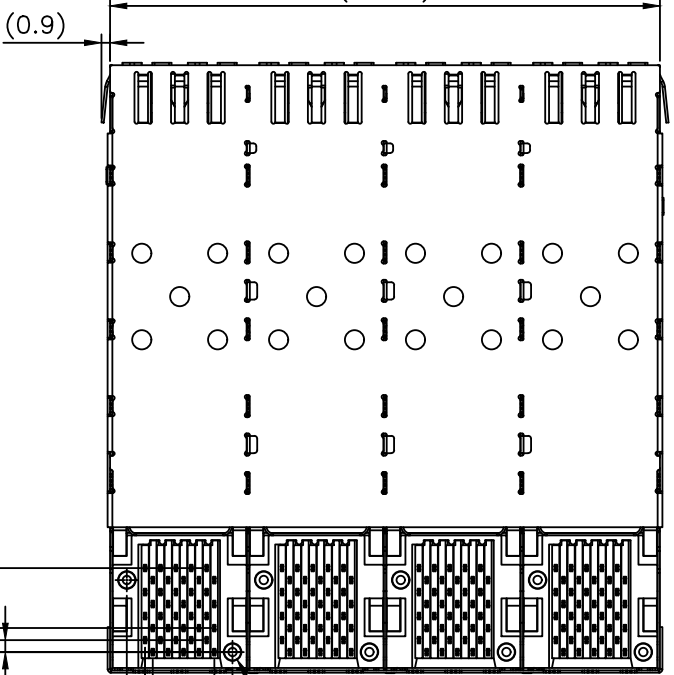
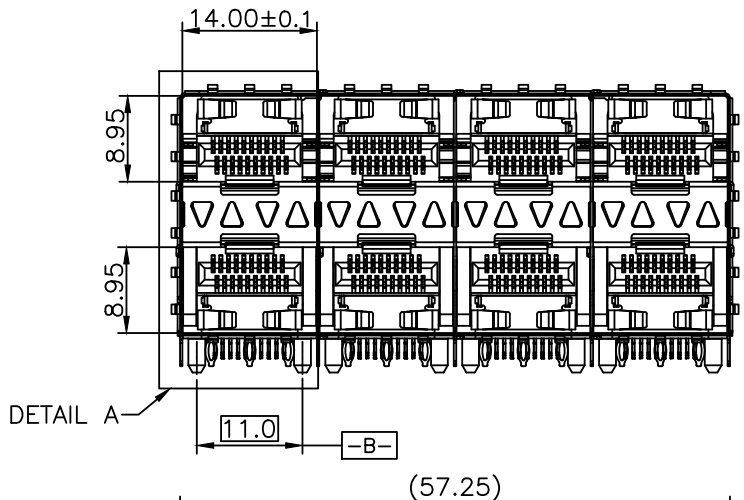

NOTES:

- MATERIAL:
 CAGE: COPPER ALLOY 30u" MIN NI-PLATED, THICKNESS 0.25 MM
 CONNECTOR:
 PLASTIC HOUSING: HIGH TEMPERATURE LCP, UL94 V-0.
 LIGHT PIPE: POLYCARBONATE; COLOR: CLEAR
 SPRING: STAINLESS STEEL, THICKNESS 0.20mm
 CONTACTS: PHOSPHOR BRONZE, THICKNESS 0.20mm
 PLATING: 15u" MIN. GOLD ON MATING AREA,
 150u" MIN. MATE TIN ON SOLDER TAILS.
 PACKAGING: TRAY PACKAGING.
 OPERATING TEMPERATURE: -40°C TO +85°C
 STORAGE TEMPERATURE: -55°C TO +105°C

TITLE SFP 2X4 CAGE+CONNECTOR			CND-tek 深圳磁联达电子有限公司 Shen zhen cnd-tek Electronics Co., Ltd				
PART NO. SFP 1658390 2x4Y			GENERAL TOLERANCE		UNIT:MM	SIZE: A4	
APPROVE	CHECK	DRAW	.X±0.20	.X±1*	SCALE: 1:1	SHEET:1/4	
QG.CHEN	SL.WANG	X.YAN	.XX±0.15	.XX±5*			REV:A
			.XXX±0.10				

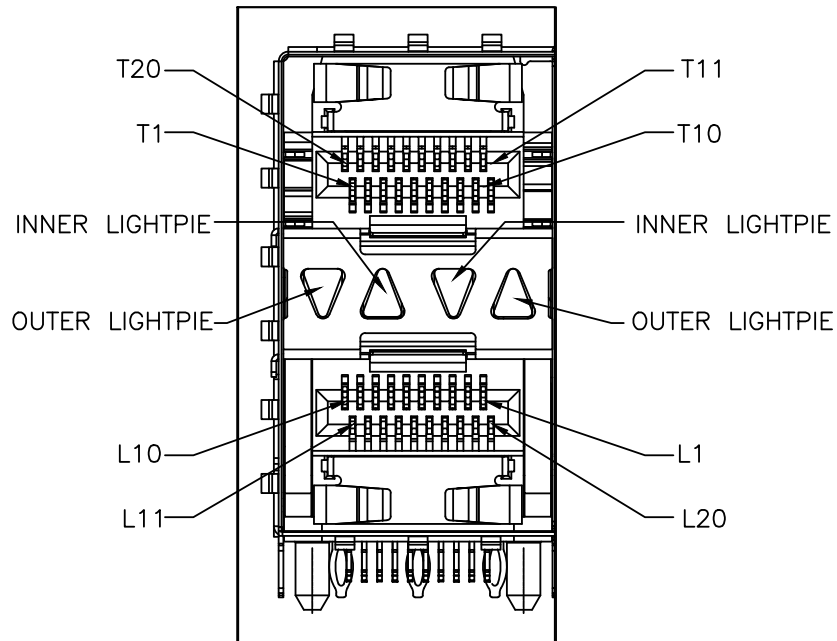
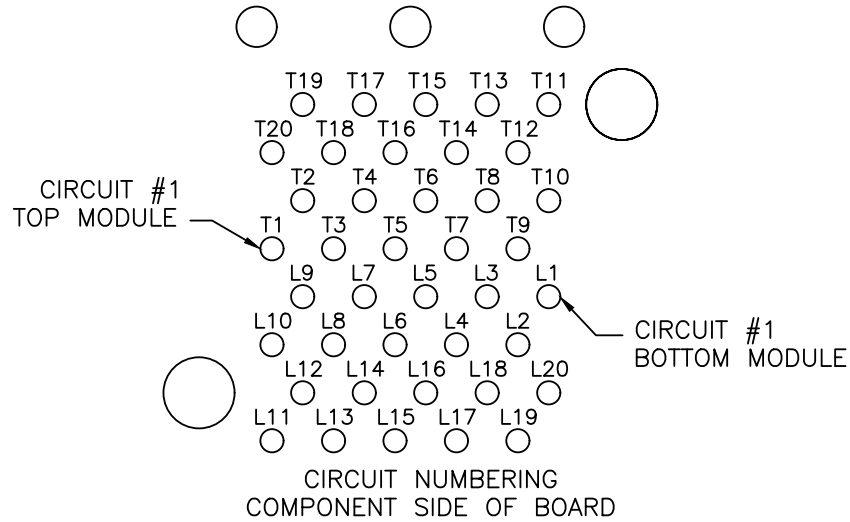

DETAIL A
CIRCUIT NUMBERING
AND LIGHTPIPE INDENTIFICATION

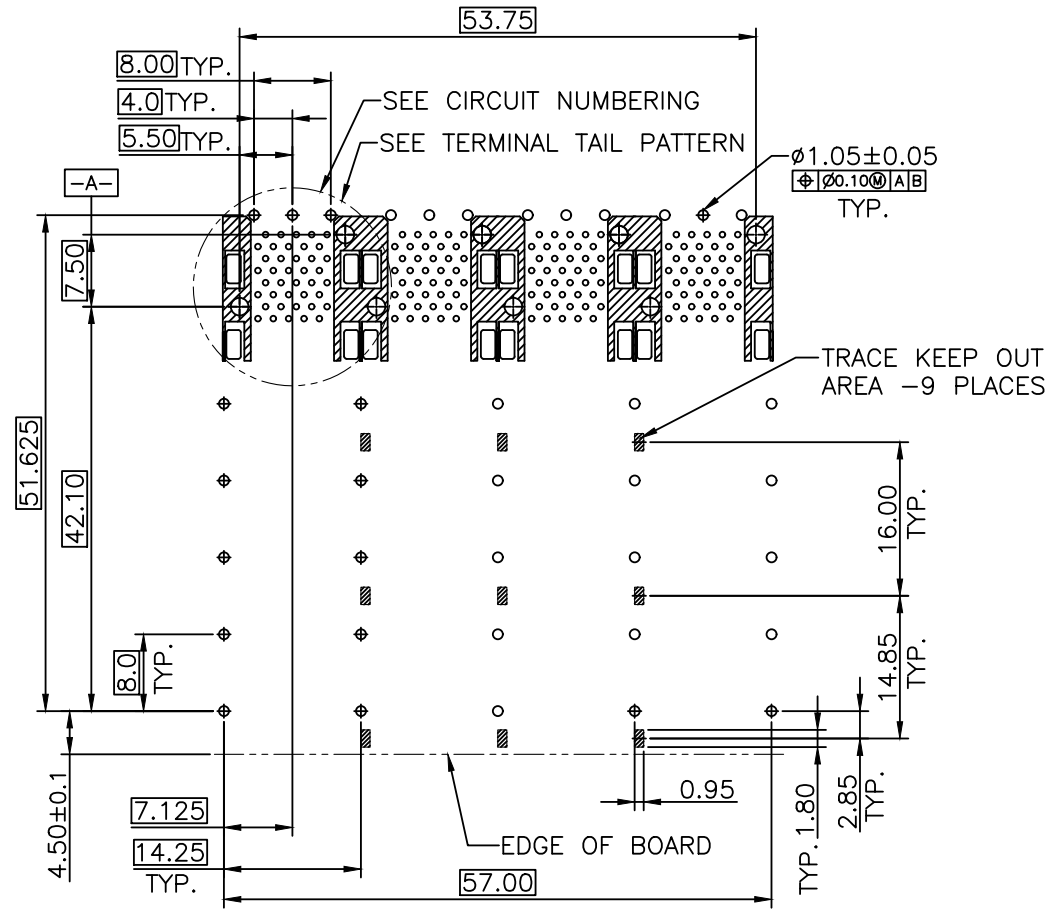

RECOMMENDED PCB LAYOUT - COMPONENT SIDE
RECOMMENDED PCB THICKNESS : 2.36MM(.093 INCH)
(MINIMUM PCB THICKNESS : 1.57)

THE ENTIRE AREA OF THE CONNECTOR FOOTPRINT
TO BE CONSIDERED THE KEEP OUT AREA FOR COMPONENTS
THIS AREA IS INDICATED BY THE DASHED LINE

TITLE SFP 2X4 CAGE+CONNECTOR			CND-tek 深圳磁联达电子有限公司 Shen zhen cnd-tek Electronics Co., Ltd			
PART NO. SFP 1658390 2x4Y			GENERAL TOLERANCE		UNIT:MM	SIZE: A4
APPROVE	CHECK	DRAW	.X±0.20	.X±1°	SCALE: 1:1	SHEET:2/4
QG.CHEN	SL.WANG	X.YAN	.XX±0.15	.XX±5°		
			.XXX±0.10			

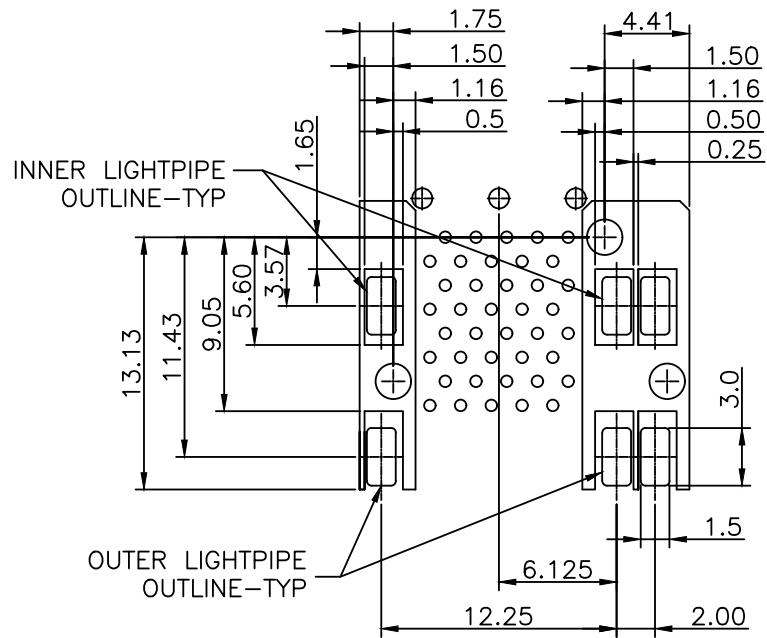

DETAIL-KEEPOUT ZONES

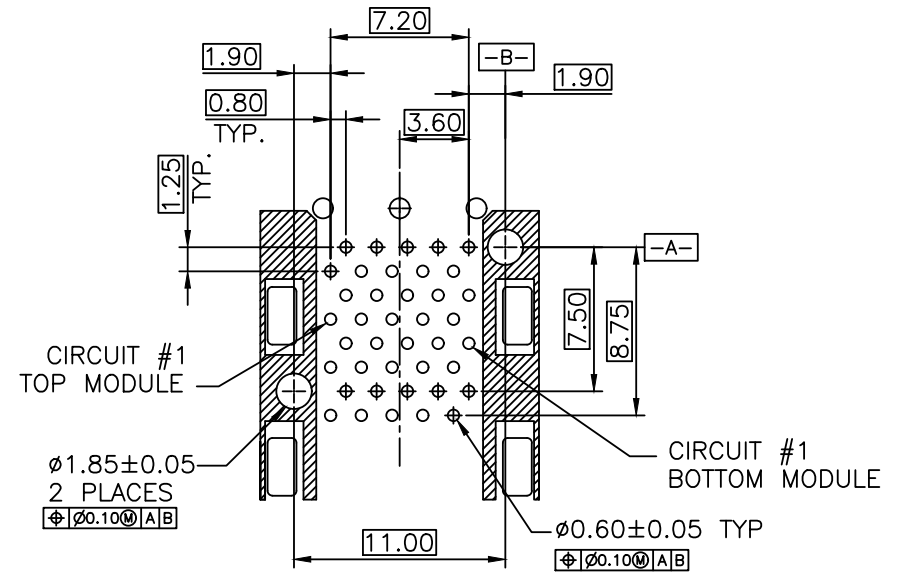

TERMINAL TAIL PATTERN

THE HATCHED AREA IN THIS VIEW INDICATES ZONES THAT ARE OCCUPIED BY THE PLASTIC HOUSING THAT SEATS AGAINST THE PCB AND BY THE VERTICAL METAL CAGE WALL THAT STOPS JUST SHORT OF THE PCB

TITLE SFP 2X4 CAGE+CONNECTOR			CND-tek 深圳磁联达电子有限公司 Shen zhen cnd-tek Electronics Co., Ltd			
PART NO. SFP 1658390 2x4Y			GENERAL TOLERANCE		UNIT:MM	SIZE: A4
APPROVE	CHECK	DRAW	.X±0.20	.X±1°	SCALE: 1:1	SHEET:3/4
QG.CHEN	SL.WANG	X.YAN	.XX±0.15	.XX±5°		
			.XXX±0.10			

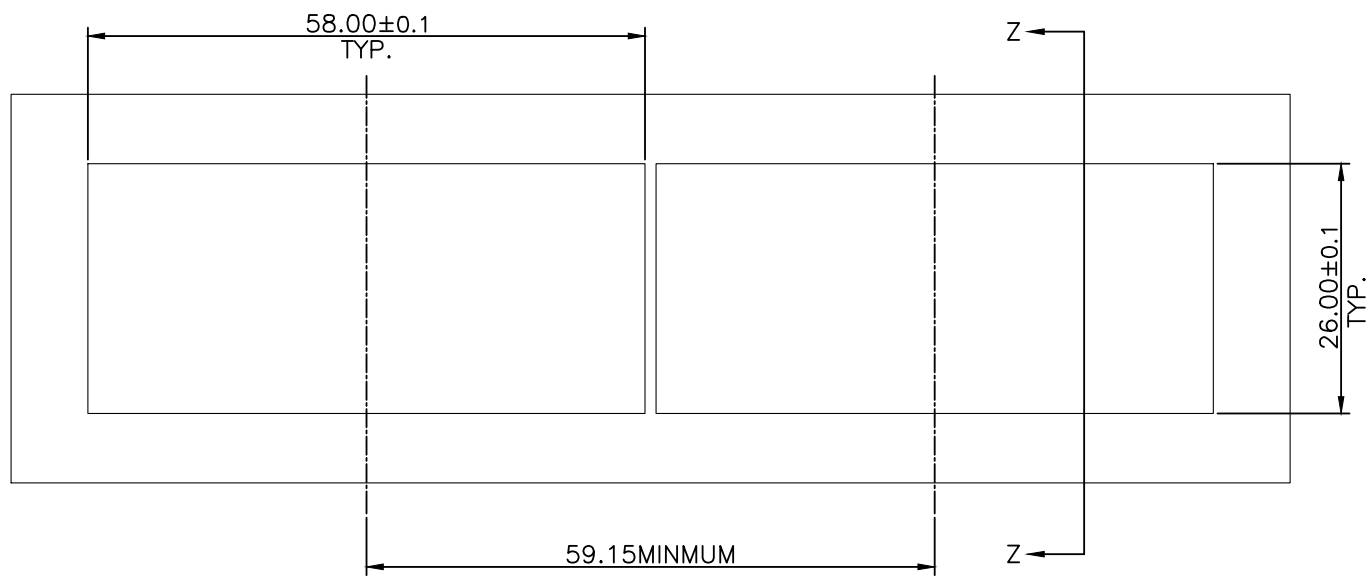

BEZEL CUT-OUT CENTER SPACING DETAIL

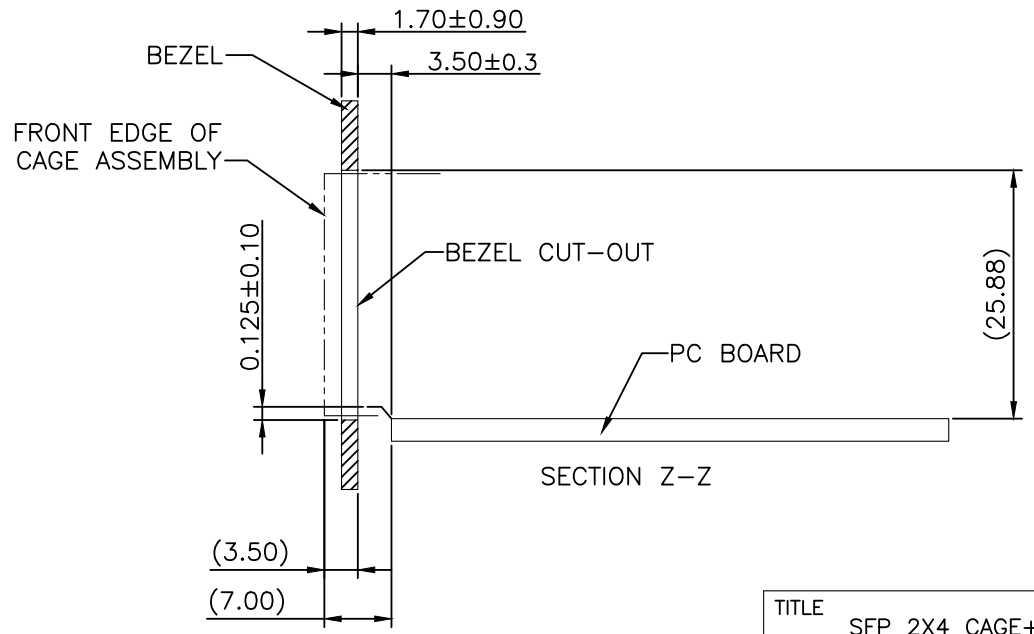

TITLE SFP 2X4 CAGE+CONNECTOR			CND-tek 深圳磁联达电子有限公司 Shen zhen cnd-tek Electronics Co., Ltd			
PART NO. SFP 1658390 2×4Y			GENERAL TOLERANCE		UNIT:MM	SIZE: A4
APPROVE	CHECK	DRAW	.X±0.20	.X±1°	SCALE: 1:1	SHEET:4/4
Q.G.CHEN	SL.WANG	X.YAN	.XX±0.15	.XX±5°		
			.XXX±0.10			