

34149 ✓ ACTIVE

PLASTI-GRIP

TE Internal #: 34149

Closed Ring Tongue Terminal, 22 – 16 AWG, #10 Stud, 4.82 mm [.19 in] Stud Diameter, Closed Barrel, Straight, Tin Plating, PLASTI-GRIP

[View on TE.com >](#)



Terminals & Splices > Ring Terminals

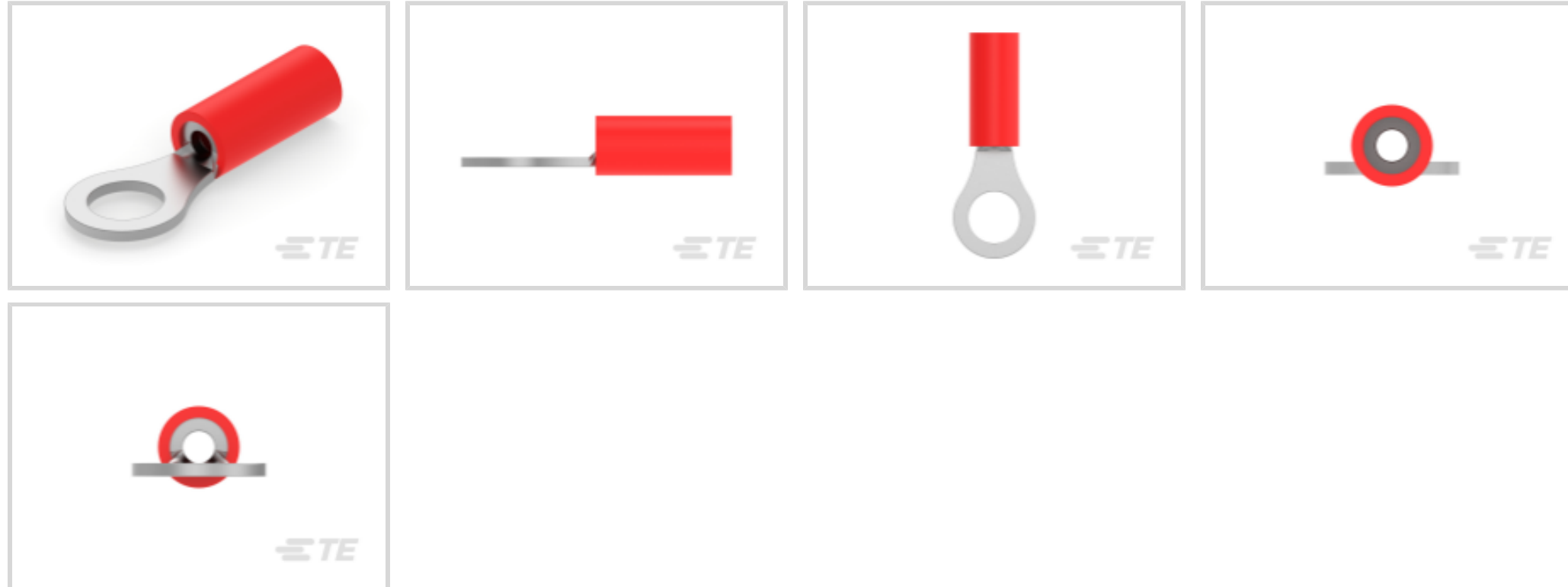

Ring Terminal Product Type: Closed Ring Tongue Terminal

Wire Size: 509 – 3260 CMA

Stud Size: #10

Features

Configuration Features

Number of Holes	1
-----------------	---

Body Features

Product Weight	2.432 g
----------------	---------

Mechanical Attachment

Wire Insulation Support	With
-------------------------	------

Electrical Characteristics

Voltage Rating	600 V
----------------	-------

Industry Standards

Government Qualified Terminal	No
-------------------------------	----

Packaging Features

Packaging Quantity	1000
--------------------	------

Packaging Method	Loose Piece
------------------	-------------

Product Type Features

Ring Terminal Product Type	Closed Ring Tongue Terminal
----------------------------	-----------------------------



Stud Size	#10
Sealable	No
Wire Insulation Support Retention Type	Insulation Support

Contact Features

Barrel Type	Closed
Terminal Orientation	Straight
Terminal Plating Material	Tin

Dimensions

Wire Size	509 – 3260 CMA
Stud Diameter	4.82 mm [.19 in]
Tongue Thickness	.79 mm [.031 in]
Product Length	21.74 mm [.86 in]
Compatible Insulation Diameter (Max)	3.56 mm [.14 in]
Compatible Insulation Diameter Range	2.67 – 3.56 mm [.105 – .14 in]

Usage Conditions

Insulation Option	Partially Insulated
-------------------	---------------------

Operation/Application

Compatible With Wire Base Material	Copper
Compatible With Wire Plating Material	Tin

Other

EU RoHS Compliance	Compliant
EU ELV Compliance	Compliant

Product Compliance

[For compliance documentation, visit the product page on TE.com>](#)

EU RoHS Directive 2011/65/EU	Compliant
EU ELV Directive 2000/53/EC	Compliant
China RoHS 2 Directive MIIT Order No 32, 2016	No Restricted Materials Above Threshold
EU REACH Regulation (EC) No. 1907/2006	Current ECHA Candidate List: JUNE 2024 (241) Candidate List Declared Against: JUNE 2024 (241) Does not contain REACH SVHC
Halogen Content	Not Low Halogen - contains Br or Cl > 900

ppm.

Solder Process Capability

Not applicable for solder process capability

Product Compliance Disclaimer

This information is provided based on reasonable inquiry of our suppliers and represents our current actual knowledge based on the information they provided. This information is subject to change. The part numbers that TE has identified as EU RoHS compliant have a maximum concentration of 0.1% by weight in homogenous materials for lead, hexavalent chromium, mercury, PBB, PBDE, DBP, BBP, DEHP, DIBP, and 0.01% for cadmium, or qualify for an exemption to these limits as defined in the Annexes of Directive 2011/65/EU (RoHS2). Finished electrical and electronic equipment products will be CE marked as required by Directive 2011/65/EU. Components may not be CE marked. Additionally, the part numbers that TE has identified as EU ELV compliant have a maximum concentration of 0.1% by weight in homogenous materials for lead, hexavalent chromium, and mercury, and 0.01% for cadmium, or qualify for an exemption to these limits as defined in the Annexes of Directive 2000/53/EC (ELV). Regarding the REACH Regulation, the information TE provides on SVHC in articles for this part number is based on the latest European Chemicals Agency (ECHA) 'Guidance on requirements for substances in articles' posted at this URL: <https://echa.europa.eu/guidance-documents/guidance-on-reach>

Compatible Parts

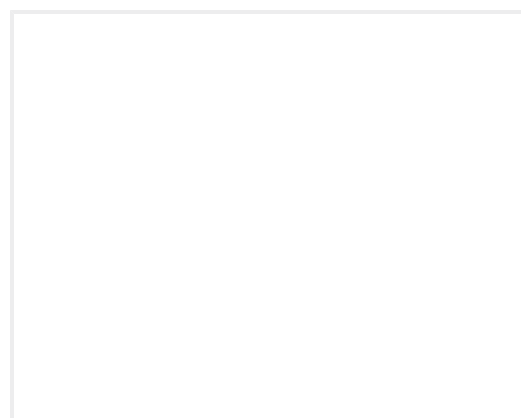

TE Part # 2392021-1
RED BATTERY DAHT KIT 110V (47689-4)



TE Part # 539691-2
ERGO DIE R.B.Y



TE Part # 169404
CERTI-LOK DIE



TE Part # 2063030-1
SDE DIESET, RBY, UL



TE Part # 59300
T-HEAD PIDG PG 26-16 ASSY



TE Part # 525690
DAHT PG PIDG 20-18 ASSY



TE Part # 59824-1
TETRA-CRIMP PIDG PG FASTON 22-10 ASSY



TE Part # 169400
CERTI-LOK FRAME W/O DIES



TE Part # 59250
T-HEAD PIDG 26-14 ASSY

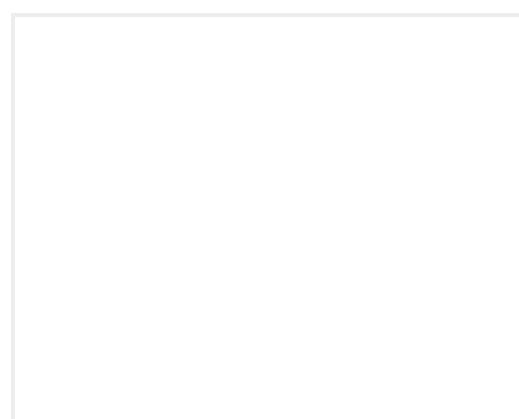

TE Part # 2392021-2
RED BATTERY DAHT KIT 220V (47689-4)



TE Part # 47806-2
DIES PIDG 22-16 DIE SET



TE Part # 58423-1
DIE, RBY IS9252



Also in the Series | **PLASTI-GRIP**

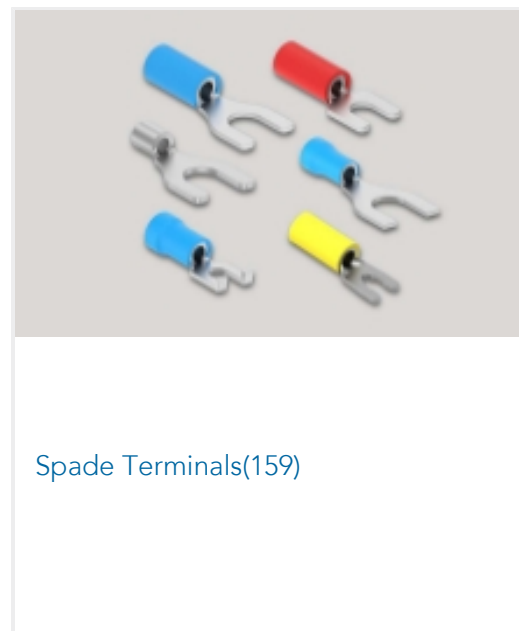
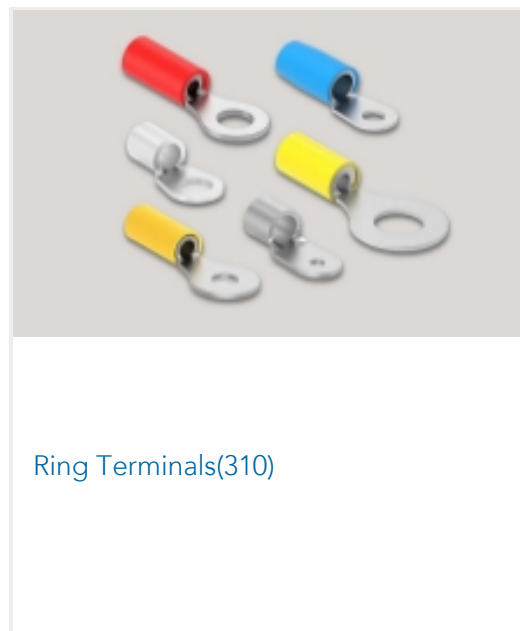
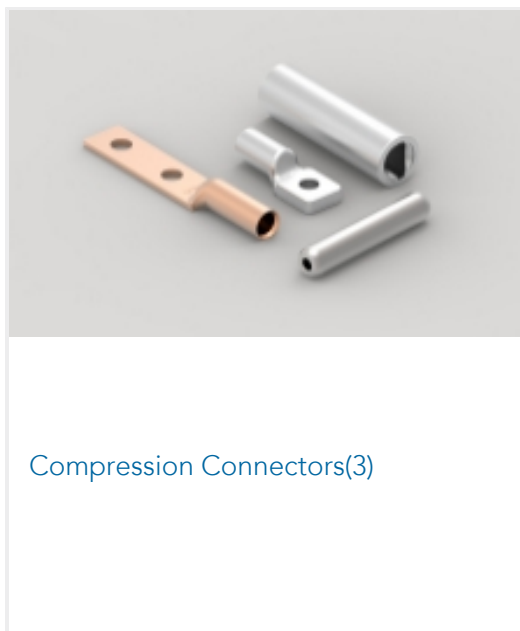

Customers Also Bought

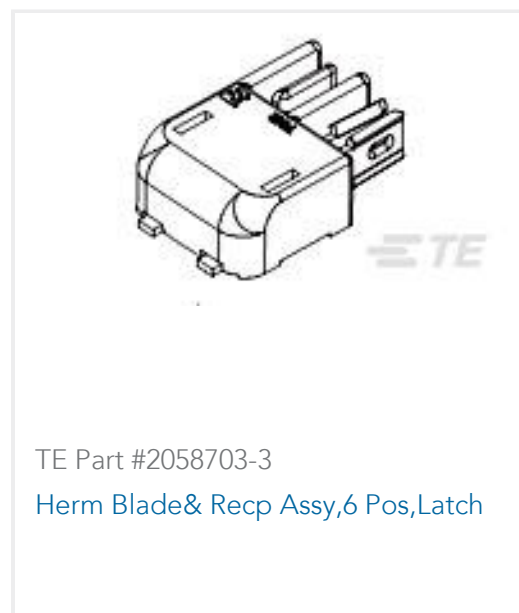



Documents

Product Drawings

[PG R 22-16 COMM 22-18 MIL 10](#)

English

CAD Files

Customer View Model

[ENG_CVM_CVM_34149_S.2d_dxf.zip](#)

English

[3D PDF](#)

3D

Customer View Model

[ENG_CVM_CVM_34149_S.3d_igs.zip](#)

English

Customer View Model

[ENG_CVM_CVM_34149_S.3d_stp.zip](#)

English

By downloading the CAD file I accept and agree to the [Terms and Conditions](#) of use.

Product Specifications

[Application Specification](#)

English

Agency Approvals

[UL Report](#)

English

[UL Report](#)

English

[UL Report](#)

English