

MSKSEMI 美森科

SEMICONDUCTOR



ESD



TVS



TSS



MOV



GDT



PLED

DMP3013SFV-MS

Product specification

Description

The DMP3013SFV-MS uses advanced trench technology to provide excellent $R_{DS(ON)}$, low gate charge and operation with gate voltages as low as 4.5V. This device is suitable for use as a Battery protection or in other Switching application.



Features

- $V_{DS} = -30V$ $I_D = -55A$
- $R_{DS(ON)} < 11m\Omega$ @ $V_{GS} = 10V$

Application

- Battery protection
- Load switch
- Uninterruptible power supply

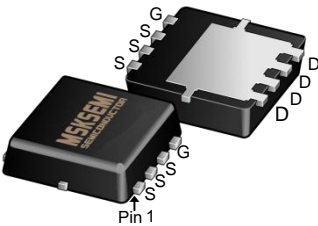
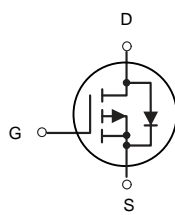
Reference News

DFN3X3-8L	P-Channel MOSFET	Marking
		

Absolute Maximum Ratings ($T_c=25^\circ C$ unless otherwise noted)

Symbol	Parameter	Rating	Units
VDS	Drain-Source Voltage	-30	V
VGS	Gate-Source Voltage	± 20	V
$I_D @ T_c=25^\circ C$	Continuous Drain Current, V_{GS} @ 10V ¹	-55	A
$I_D @ T_c=100^\circ C$	Continuous Drain Current, V_{GS} @ 10V ¹	-23	A
IDM	Pulsed Drain Current ²	-140	A
EAS	Single Pulse Avalanche Energy ³	78.8	mJ
$P_D @ T_c=25^\circ C$	Total Power Dissipation ⁴	21.5	W
TSTG	Storage Temperature Range	-55 to 150	$^\circ C$
T_J	Operating Junction Temperature Range	-55 to 150	$^\circ C$
$R_{\theta JC}$	Thermal Resistance Junction-Case ¹	5.8	$^\circ C/W$

Electrical Characteristics (T_J=25°C unless otherwise specified)

Symbol	Parameter	Test Condition	Min.	Typ.	Max.	Units
V _{(BR)DSS}	Drain-Source Breakdown Voltage	V _{GS} =0V, I _D = -250μA	-30	-	-	V
I _{DSS}	Zero Gate Voltage Drain Current	V _{DS} = -30V, V _{GS} = 0V,	-	-	-1	μA
I _{GSS}	Gate to Body Leakage Current	V _{DS} =0V, V _{GS} = ±20V	-	-	±100	nA
V _{GS(th)}	Gate Threshold Voltage	V _{DS} = V _{GS} , I _D = -250μA	-1.0	-1.5	-2.5	V
R _{DS(on)}	Static Drain-Source on-Resistance <small>note3</small>	V _{GS} =-10V, I _D =-12A	-	8.5	11	mΩ
		V _{GS} =-4.5V, I _D =-8A	-	13	18	
C _{iss}	Input Capacitance	V _{DS} = -15V, V _{GS} = 0V, f = 1.0MHz	-	2800	-	pF
C _{oss}	Output Capacitance		-	346	-	pF
C _{rss}	Reverse Transfer Capacitance		-	319	-	pF
Q _g	Total Gate Charge		-	30	-	nC
Q _{gs}	Gate-Source Charge	V _{DS} = -15V, I _D = -20A, V _{GS} = -10V	-	5.3	-	nC
Q _{gd}	Gate-Drain("Miller") Charge		-	7.6	-	nC
t _{d(on)}	Turn-on Delay Time	V _{DD} = -15V, I _D = -20A, V _{GS} =-10V, R _{GEN} =2.5Ω	-	14	-	ns
t _r	Turn-on Rise Time		-	20	-	ns
t _{d(off)}	Turn-off Delay Time		-	95	-	ns
t _f	Turn-off Fall Time		-	65	-	ns
I _S	Maximum Continuous Drain to Source Diode Forward Current		-	-	-55	A
I _{SM}	Maximum Pulsed Drain to Source Diode Forward Current		-	-	-140	A
V _{SD}	Drain to Source Diode Forward Voltage	V _{GS} = 0V, I _S = -35A	-	-0.8	-1.2	V

Notes:

1. Repetitive Rating: Pulse Width Limited by Maximum Junction Temperature
2. EAS condition: T_J= 25°C, V_{DD}= -20V, V_G= -10V, L= 0.5mH, R_G= 25Ω, I_{AS}= -17A
3. Pulse Test: Pulse Width≤300μs, Duty Cycle≤2%

Typical Performance Characteristics

Figure 1: Output Characteristics

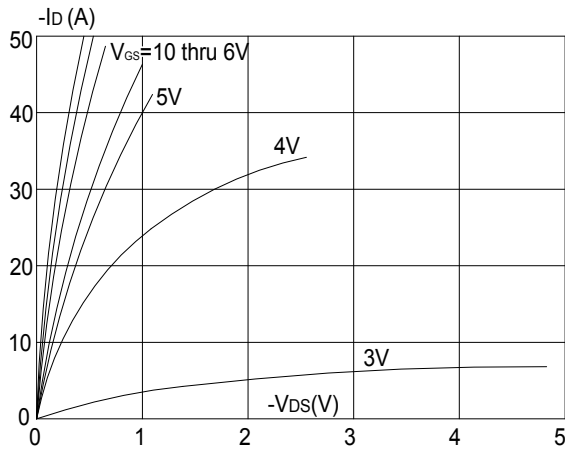

Figure 2: Typical Transfer Characteristics

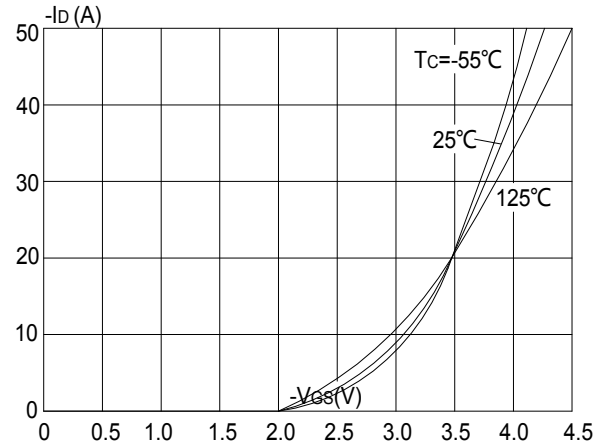

Figure 3: On-resistance vs. Drain Current

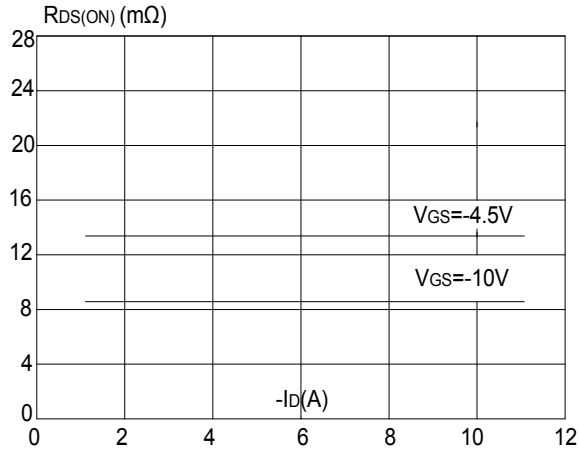

Figure 4: Body Diode Characteristics

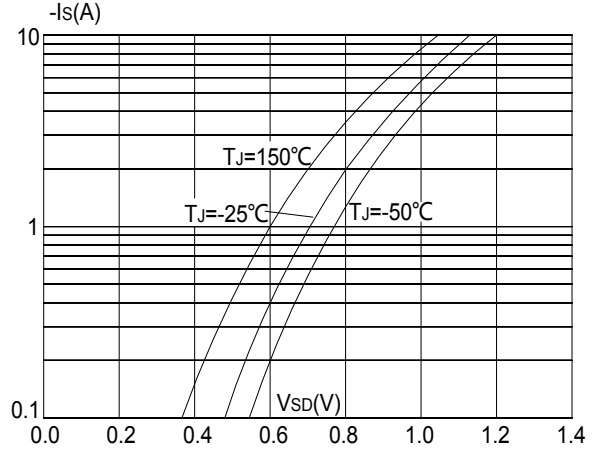

Figure 5: Gate Charge Characteristics

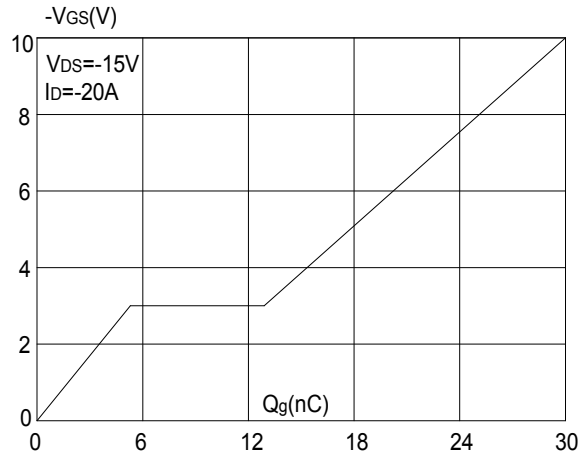

Figure 6: Capacitance Characteristics

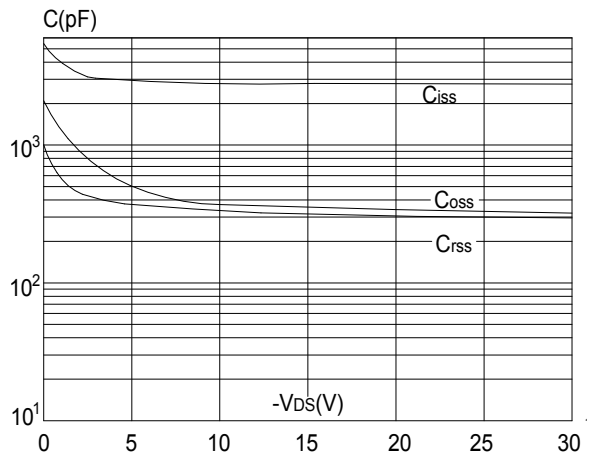

Figure 7: Normalized Breakdown Voltage vs. Junction Temperature

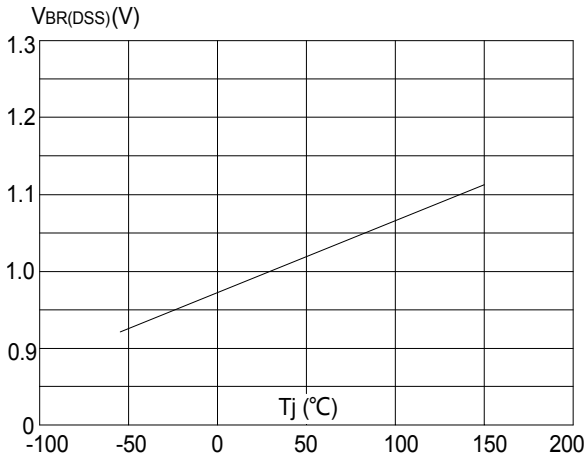

Figure 8: Normalized on Resistance vs. Junction Temperature

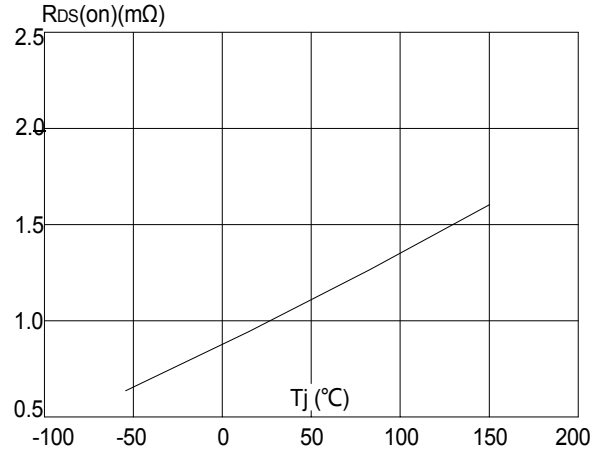

Figure 9: Maximum Safe Operating Area

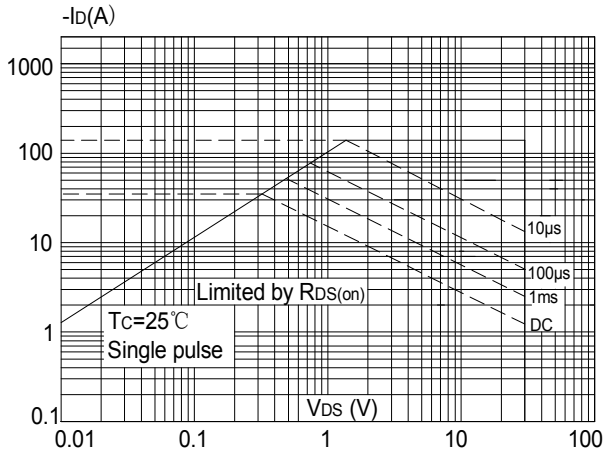

Figure 10: Maximum Continuous Drain Current vs. Case Temperature

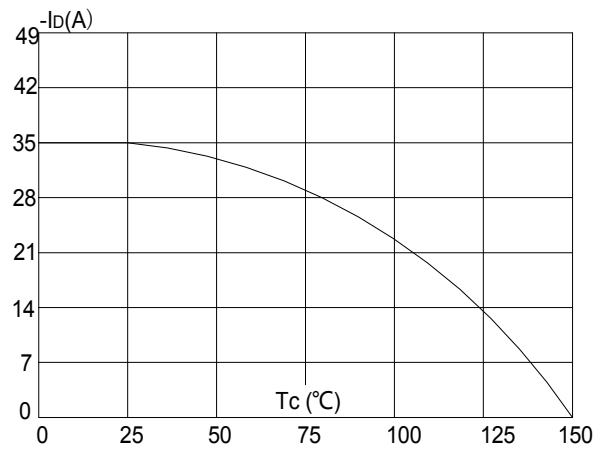
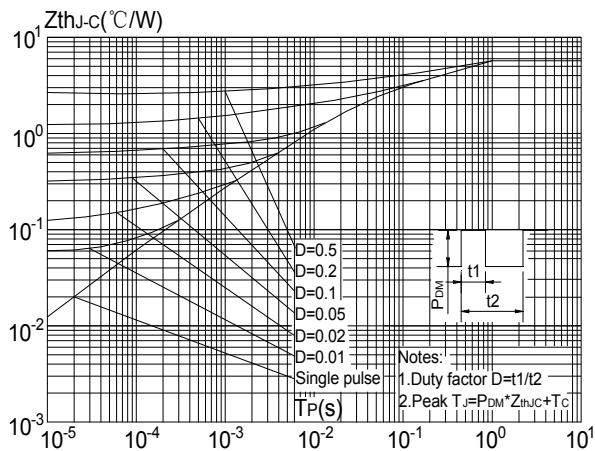
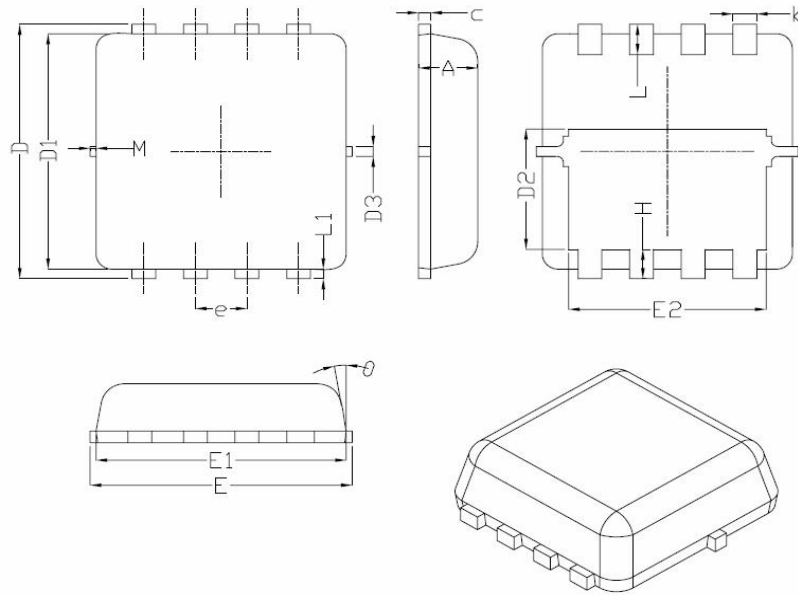

Figure.11: Maximum Effective Transient Thermal Impedance, Junction-to-Case



DFN3X3-8L Package Information



Symbol	Dimensions In Millimeters		
	Min.	Nom.	Max.
A	0.70	0.75	0.80
b	0.25	0.30	0.35
c	0.10	0.15	0.25
D	3.25	3.35	3.45
D1	3.00	3.10	3.20
D2	1.48	1.58	1.68
D3	-	0.13	-
E	3.20	3.30	3.40
E1	3.00	3.15	3.20
E2	2.39	2.49	2.59
e	0.65BSC		
H	0.30	0.39	0.50
L	0.30	0.40	0.50
L1	-	0.13	-
M	*	*	0.15
θ		10°	12°

REEL SPECIFICATION

P/N	PKG	QTY
DMP3013SFV-MS	DFN3X3-8L	5000

Attention

- Any and all MSKSEMI Semiconductor products described or contained herein do not have specifications that can handle applications that require extremely high levels of reliability, such as life-support systems, aircraft's control systems, or other applications whose failure can be reasonably expected to result in serious physical and/or material damage. Consult with your MSKSEMI Semiconductor representative nearest you before using any MSKSEMI Semiconductor products described or contained herein in such applications.
- MSKSEMI Semiconductor assumes no responsibility for equipment failures that result from using products at values that exceed, even momentarily, rated values (such as maximum ratings, operating condition ranges, or other parameters) listed in products specifications of any and all MSKSEMI Semiconductor products described or contained herein.
- Specifications of any and all MSKSEMI Semiconductor products described or contained herein stipulate the performance, characteristics, and functions of the described products in the independent state, and are not guarantees of the performance, characteristics, and functions of the described products as mounted in the customer's products or equipment. To verify symptoms and states that cannot be evaluated in an independent device, the customer should always evaluate and test devices mounted in the customer's products or equipment.
- MSKSEMI Semiconductor strives to supply high-quality high-reliability products. However, any and all semiconductor products fail with some probability. It is possible that these probabilistic failures could give rise to accidents or events that could endanger human lives, that could give rise to smoke or fire, or that could cause damage to other property. When designing equipment, adopt safety measures so that these kinds of accidents or events cannot occur. Such measures include but are not limited to protective circuits and error prevention circuits for safe design, redundant design, and structural design.
- In the event that any or all MSKSEMI Semiconductor products (including technical data, services) described or contained herein are controlled under any of applicable local export control laws and regulations, such products must not be exported without obtaining the export license from the authorities concerned in accordance with the above law.
- No part of this publication may be reproduced or transmitted in any form or by any means, electronic or mechanical, including photocopying and recording, or any information storage or retrieval system, or otherwise, without the prior written permission of MSKSEMI Semiconductor.
- Information (including circuit diagrams and circuit parameters) herein is for example only ; it is not guaranteed for volume production. MSKSEMI Semiconductor believes information herein is accurate and reliable, but no guarantees are made or implied regarding its use or any infringements of intellectual property rights or other rights of third parties.
- Any and all information described or contained herein are subject to change without notice due to product/technology improvement, etc. When designing equipment, refer to the "Delivery Specification" for the MSKSEMI Semiconductor product that you intend to use.