

**SPECIFICATION SHEET**

<b>SPECIFICATION SHEET NO.</b>	Q0129 - XP27M00000S410
<b>DATE</b>	Jan. 29, 2023
<b>REVISION</b>	A0
<b>DESCRIPTION</b>	MHz SMD Crystal, L6.0*W3.5*H1.2mm, Glass Seal, 2 Pads, CMG632 series 27.000MHz, Tolerance +/-30ppm, Load Capacitor 10pF, Frequency stability +/-30ppm @Operating Temp. Range -40°C ~+85°C, ESR 50 ohm Max, Reflow Profile Condition 260 °C Max. Tape/Reel, 1000pcs/Reel RoHS/RoHS III compliant, RoHS Annex III lead Exemption (exempt per RoHS EU 2015/863)
<b>CUSTOMER</b>	
<b>CUSTOMER PART NUMBER</b>	
<b>CROSS REF. PART NUMBER</b>	
<b>ORIGINAL PART NUMBER</b>	TGS CMG632 27M0A30-10-30-40-50 TLH
<b>PART CODE</b>	XP27M00000S410

<b>VENDOR APPROVE</b>			
Issued/Checked/Approved			
DATE: Jan. 29, 2023			

<b>CUSTOMER APPROVE</b>	
DATE:	

1/29/2023

**MHz SMD CRYSTAL GLASS SEAL 6035 TYPE 2 PADS**

**MAIN FEATURE**

- MHz SMD Crystal Glass seal, 2 Pads, L6.0\*W3.5\*H1.2mm
- Low cost, High precision, High frequency stability
- Reflow Profile Condition 260 °C Max.
- Cross more competitors part
- RoHS/RoHS III compliant, RoHS Annex III lead Exemption (exempt per RoHS EU 2015/863)



**APPLICATION**

- Measurement Instrument
- Communication Electronics

**PART CODE GUIDE**

**RFQ**

[Request For Quotation](#)

XP	27M00000	S	410
1	2	3	4

- 1) XP: Part family Code for SMD Crystal Glass seal, L6.0\*W3.5\*H1.2mm, 2 Pads, CMG632 series
- 2) 27M00000: Frequency range code for 27.0000MHz
- 3) S: SMD type, Package Tape/Reel, 1000pcs/Reel
- 4) 410: Specification code for original part no. **TGS CMG632 27M0A30-10-30-40-50 TLH**

**MHZ SMD CRYSTAL GLASS SEAL 6035 TYPE 2 PADS**

DIMENSION (Unit: mm, +/-0.2mm)

Image for reference



Top View



**Marking**

Frequency Range  
or Internal control  
code

Bottom type 1  
View



OR

Bottom Type 2  
View



Pin Configuration

#1 Crystal

#2 Crystal

Side View



**MHZ SMD CRYSTAL GLASS SEAL 6035 TYPE 2 PADS**
**ELECTRICAL PARAMETERS**

Parameter	Part No. Symbol	Units	Value			Condition
			Min.	Typical	Max.	
Original Manufacturer	TGS		TGS Crystals			
Holder Type	CMG632		MHz SMD Crystal, Glass Seal, L6.0*W3.5*H1.2mm, 2 pads			
Frequency Range	27M0	MHz	27.000			
Mode of Oscillation	A		AT Fundamental			
Frequency Tolerance	30	ppm	-30		+30	@25°C
Load Capacitance	-10	pF	10			
Stability over Operation Temperature	-30	ppm	-30		+30	
Operation Temperature	-40	°C	-40		+85	
Storage Temperature		°C	-40		+85	
Equivalent Series Resistance (ESR)	50	Ω			50	
Drive Level		μW			100	
Shunt Capacitance (C0)		pF	0		5.0	
Motional Capacitance (C1)		fF	N/A			
DLD2		Ω	N/A			
FLD2		ppm	N/A			
RDL2		Ω	N/A			
SPDB		dB	N/A			
Aging		ppm/year			±3	@1 <sup>st</sup> year
Insulation Resistance		MΩ	500			@100VDC ± 15Vdc
Others	Package	T	Tape/Reel, 1000pcs/Reel			
	RoHS Status	LH	RoHS III compliant, RoHS Annex III lead Exemption (exempt per RoHS EU 2015/863)			
	Add Value		N/A			
	Internal Control Code *		N/A			

 Note: 1) Original Part Number: **TGS CMG632 27M0A30-10-30-40-50 TLH**

2) \* Internal Control Code- 2 letter or digits; Blank: N/A

1/29/2023

**MHZ SMD CRYSTAL GLASS SEAL 6035 TYPE 2 PADS**
**RELIABILITY**

Test Items	Test Method And Conditions	Reference Documents
High Temperature High Humidity Storage	Temperature: 85°C±3°C Relative Humidity:85%RH Time: 96 Hours	JIS C5023
High Temperature Storage	Temperature: 125°C±3°C Time: 96 Hours.	MIL-STD-883E Method 1005.8
Low Temperature Storage	Temperature: -40°C±3°C Time: 96 Hours.	MIL-STD-883E Method 1013
Thermal Shock	Temperature 1: -55°C±5°C Temperature 2: 85°C±5 °C Temperature change between T1 and T2 5 min 10cycles maintain T1 and T2 for 30 minutes each cycle	MIL-STD-202F Method 107 Condition A
Resistance to Solder Heat	Solder Temperature: 260°C±5°C Time: 10±1 Seconds	MIL-STD-202F Method 210E
Solderability	The solder pot temperature is 245±5°C , dwell time 5±0.5sec	J-STD-002B
Drop Test	3 Times Free Fall from 50cm height table to 3cm thickness hard wood board	J-STD-002B
Mechanical Shock	Half sine wave,1000 G 3 Times for all 3 directions(X,Y Z)	MIL STD 202F Method 213B
Vibration	Frequency Range: 10Hz ~ 55Hz Amplitude: 0.75mm 2 Hours in each direction, total 6 Hours	MIL-STD-883E Method 2007.3
Leakage Test	Take measurements with a helium Leakage detector Leakage Rate≤1×10 <sup>-3</sup> Pa cm <sup>3</sup> /s	MIL-STD-883E

**MHZ SMD CRYSTAL GLASS SEAL 6035 TYPE 2 PADS**

**SUGGESTED REFLOW PROFILE (For Reference Only)**

Total time: 200 Sec. Max. Solder melting point: 220°C



<b>Profile Feature</b>		Pb-Free Assembly
<b>Average Ramp-up Rate (Ts Max to Tp)</b>		3°C/second Max
<b>Preheat</b>	<b>Temperature Min (Ts Min.)</b>	125°C
	<b>Temperature Max (Ts Max.)</b>	200°C
	<b>Time (ts Min. to ts Max.)</b>	60 ~ 180 seconds
<b>Time maintained above</b>	<b>Temperature (Tl)</b>	217°C
	<b>Time (tL)</b>	60 ~ 150 seconds
<b>Peak/Classification Temperature (Tp)</b>		260 °C
<b>Time within 5°C of actual Peak Temperature (tp)</b>		20 ~ 40 seconds
<b>Ramp-down rate</b>		6 °C /Second Max.
<b>Time 25 °C to Peak Temperature</b>		8 minutes Max.
<b>Suggest reflow times</b>		3 Times Max.

**MHZ SMD CRYSTAL GLASS SEAL 6035 TYPE 2 PADS**

**TAPE/REEL (Unit: mm, 1000pcs/Reel)**

All Devices are packed in accordance with EIA standard RS-481-2 and specifications., 1000pcs/Reel



Code	Dimension (mm)
A	1.70
B	5.45
C	3.65
D	8.00
E	12.0

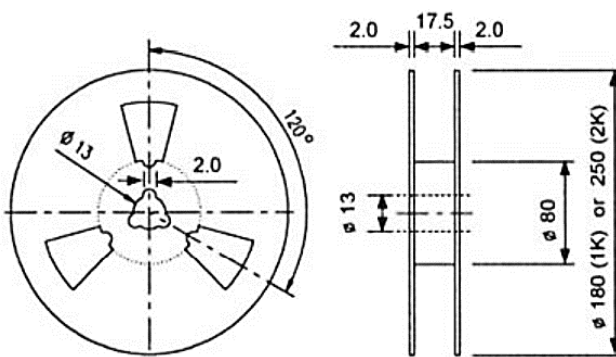

**DISCLAIMER**

NextGen Components, Inc. reserves the right to make changes to the product(s) and or information contained herein without notice. No liability is assumed as a result of their use or application. No rights under any patent accompany the sale of any such product(s) or information