

DESCRIPTION

The MBR10200CT meet the ROHS and Green Product requirement with full function reliability approved.

FEATURE

- *Schottky Barrier Chip
- *Guard Ring Die Construction for Transient Protection
- *Low Power Loss,High Efficiency
- *High Surge Capability
- *High Current Capability and Low Forward Voltage Drop
- *For Use in Low Voltage, High Frequency Inverters,Free Wheeling, and Polarity Protection Applications

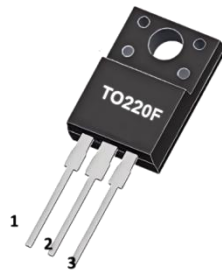

1. ANODE
2. CATHODE
3. ANODE

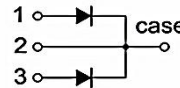

ABSOLUTE MAXIMUM RATINGS(TA=25°C, unless otherwise specified.)

SYMBOL	PARAMETER	VALUE	UNIT
VRRM	Peak repetitive reverse voltage	200	V
VRWM	Working peak reverse voltage	200	V
VR	DC blocking voltage	200	V
VR(RMS)	RMS reverse voltage	140	V
IO	Average rectified output current	10 (5*2)	A
IFSM	Non-Repetitive peak forward surge current(8.3ms half sine wave)	100*2	A
Tj	Junction temperature	175	°C
Tstg	Storage temperature	-55~+150	°C
RθJA	Thermal Resistance from Junction to Ambient	60	°C/W
RθJC	Thermal Resistance From Junction To Case	4	°C/W

Notes: Absolute maximum ratings are those values beyond which the device could be permanently damaged. Absolute maximum ratings are stress ratings only and functional device operation is not implied.

ELECTRICAL CHARACTERISTICS (TA=25°C, unless otherwise specified)

PARAMETER	SYMBOL	TEST CONDITIONS		MIN	TYP	MAX	UNIT
Reverse voltage	$V_{(BR)}$	$I_R=0.1mA$		200			V
Reverse current	I_R	$V_R=200V$			0.5	5	μA
Forward voltage	V_{F1}	$I_F=3A$	$T_j=25^\circ C$		0.82		V
	V_{F2}	$I_F=5A$	$T_j=25^\circ C$		0.85	0.88	V
			$T_j=125^\circ C$			0.74	V
V_{F3}	$I_F=10A$	$T_j=25^\circ C$			0.95	V	
Typical total capacitance	C_{tot}	$V_R=5V, f=1MHz$			50		pF

*Pulsetest:pulsewidth $\leq 300\mu s$,duty $\leq 2.0\%$.

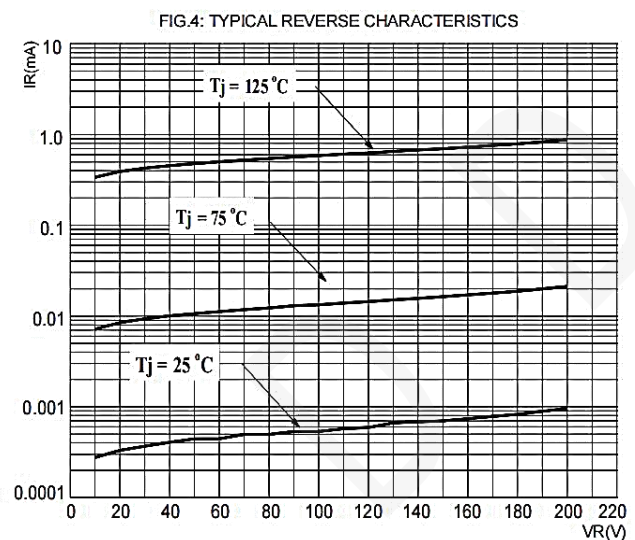
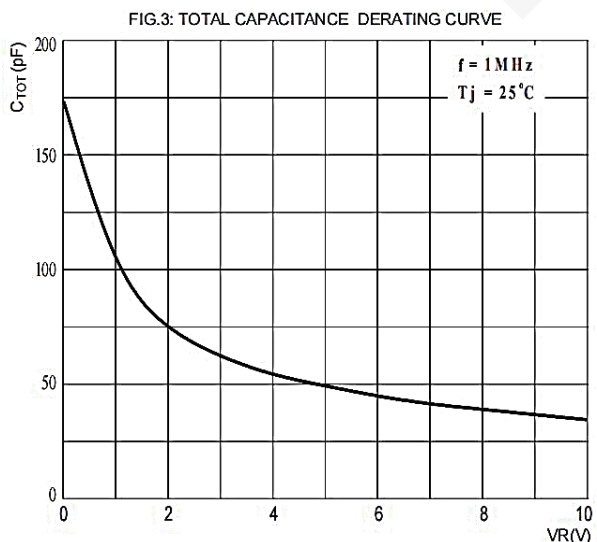
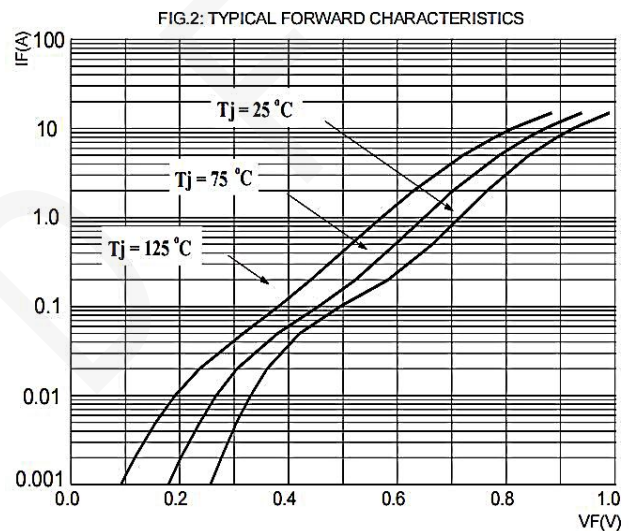
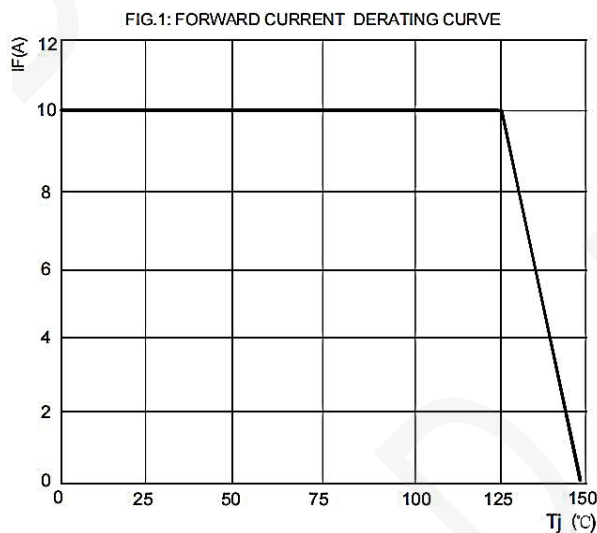
TYPICAL CHARACTERISTICS

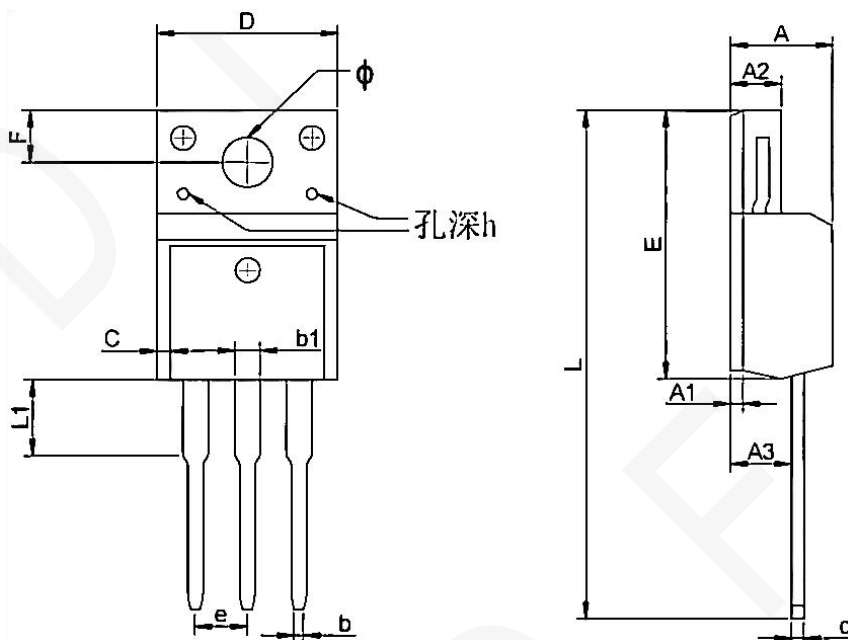
TO-220F PACKAGE OUTLINE DIMENSIONS

Symbol	Dimensions In Millimeters		Dimensions In Inches	
	Min.	Max	Min	Max
A	4.300	4.750	0.169	0.185
A1	1.830 REF		0.072 REF	
A2	2.300	2.850	0.090	0.112
A3	2.500	2.900	0.098	0.114
b	0.400	0.420	0.016	0.016
b1	1.220	1.280	0.048	0.050
C	0.690	0.720	0.027	0.028
c	0.490	0.510	0.019	0.020
D	9.960	10.200	0.392	0.400
E	15.000	15.950	0.588	0.625
e	2.574 TYP		0.101TYP	
F	3.470 REF		0.136 REF	
y	3.200 REF		0.125 REF	
h	0.000	0.300	0.000	0.012
L	28.780	28.900	1.128	1.133
L1	2.990	3.100	0.117	0.122