

ISL80101EVAL2Z

ISL80101 High Performance 1A LDO Evaluation Board User Guide

AN1592
Rev 0.00
Sep 9, 2010

Description

The ISL80101 is a high performance, low voltage, high current, low dropout linear regulator specified at 1A. Rated for input voltages from 2.2V to 6V, the LDO can provide outputs from 0.8V to 5V on the adjustable version. Salient features of the part include:

- Very Fast Load Transient Response
- ±1.8% Guaranteed VOUT Accuracy over Line, Load and Temperature
- Typical Dropout of 130mV at 1A
- Adjustable Soft-Start and In-Rush Current Limiting
- PG Feature
- Short-Circuit and Over Temperature Protection

The ISL80101EVAL2Z provides a simple platform to evaluate performance of the ISL80101. It comes with the adjustable output version of the IC. Jumpers are provided to easily set popular output voltages. Fixed output versions are sampled in the accompanying kit.

What's Inside

The evaluation kit contains the following:

- The ISL80101EVAL2Z
- Fixed output versions of ISL80101
- The ISL80101 datasheet
- This evaluation kit document

Test Steps

1. Select the desired output voltage by shorting one of the jumpers from J1 through J6.
2. Ensure that the output capacitor and C_{PB} are set according to recommended values shown in Table 1.
3. Connect the input supply and the load.
4. Enable the IC using jumper JP1 and observe the output.

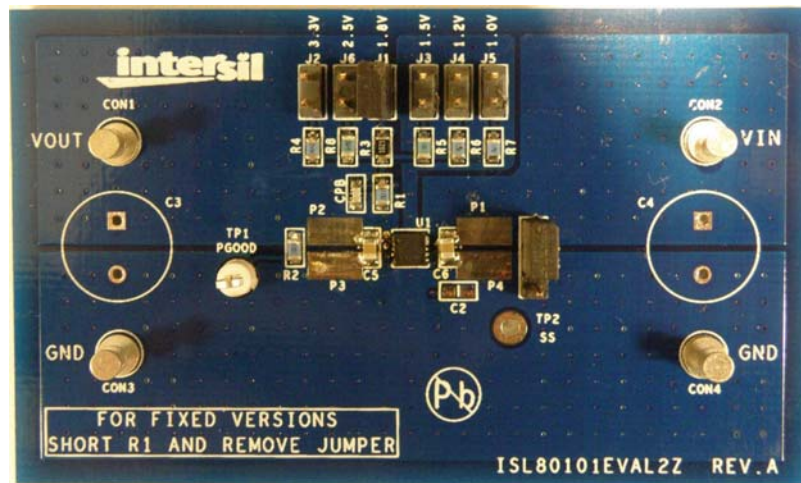

FIGURE 1. ISL80101EVAL2Z

Optimizing LDO Performance

Performance of the ISL80101 can be optimized by following these simple guidelines.

Phase Boost Capacitor (C_{PB})

On the adjustable version of the ISL80101, as shown in Figure 2, a small capacitor can be placed across the top resistor in the feedback resistor divider to place a zero at:

$$F_Z = 1/(2 \cdot \pi \cdot R_{TOP} \cdot C_{PB}) \quad (\text{EQ. 1})$$

This zero increases the crossover frequency of the LDO and provides additional phase resulting in faster load transient response.

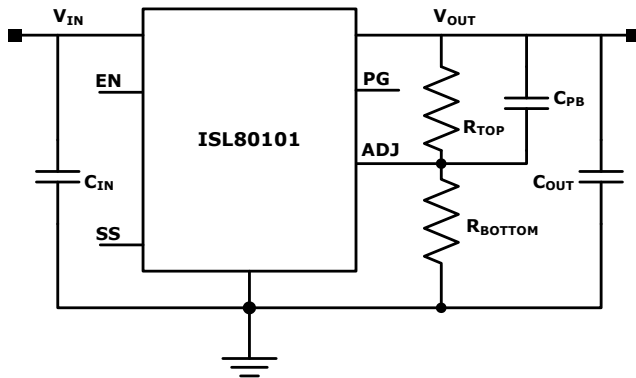

FIGURE 2. ISL80101 TYPICAL APPLICATION

Output Capacitor (C_{OUT})

Output capacitor selection is important to achieve the desired load transient performance. The ISL80101 uses state-of-the-art internal compensation to be compatible with different types of output capacitors including multi-layer ceramic, POSCAP and aluminum/tantalum electrolytic.

There is a growing trend to use very-low ESR multi-layer ceramic capacitors (MLCC) for applications because they can support fast load transients and also bypass very high frequency noise from other sources. However, effective capacitance of MLCC's drops with applied voltage, age and temperature. X7R and X5R dielectric ceramic capacitors are strongly recommended as they typically maintain a capacitance range within $\pm 20\%$ of nominal over full operating ratings of temperature and voltage.

Table 1 gives the recommended values for output capacitor (MLCC X5R/X7R) and C_{PB} for different voltage rails.

Right selection of output capacitor and C_{PB} also helps to increase PSRR at high frequencies.

TABLE 1.

V_{OUT} (V)	R_{TOP} (k Ω)	R_{BOTTOM} (Ω)	C_{PB} (pF)	C_{OUT} (μ F)
5.0	2.61	287	100	10
3.3	2.61	464	100	10
2.5	2.61	649	82	10
1.8	2.61	1.0k	82	10
1.5*	2.61	1.3k	68	10
1.5	2.61	1.3k	150	22
1.2*	2.61	1.87k	120	22
1.2*	2.61	1.87k	270	47
1.0	2.61	2.61k	220	47
0.8	2.61	4.32k	220	47

*Either option could be used depending on cost/performance requirements.

Layout Guidelines

A good PCB layout is important to achieve expected performance. Consideration should be taken when placing the components and routing the trace to minimize the ground impedance, and keep the parasitic inductance low. The input and output capacitors should have a good ground connection and be placed as close to the IC as possible. The 'SENSE' trace in fixed voltage parts and the 'ADJ' trace in adjustable voltage parts must be away from noisy planes and traces.

Typical Performance Curves

Unless otherwise specified, $V_{IN} = V_{OUT} + 0.4V$, $V_{OUT} = 1.8V$,
 $C_{IN} = C_{OUT} = 10\mu F$, $T_J = +25^\circ C$, $I_{LOAD} = 0A$

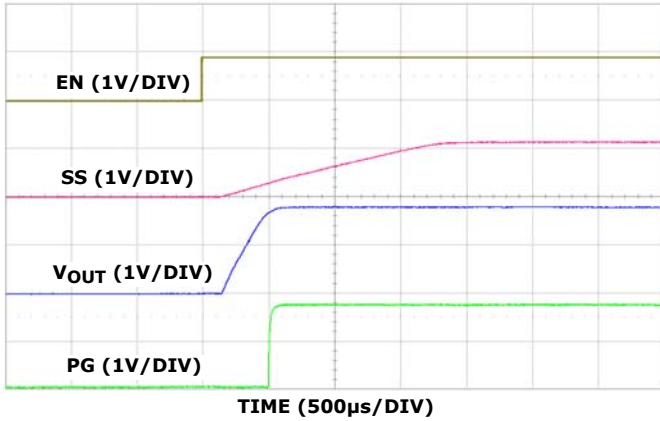

FIGURE 3. START-UP WAVEFORMS

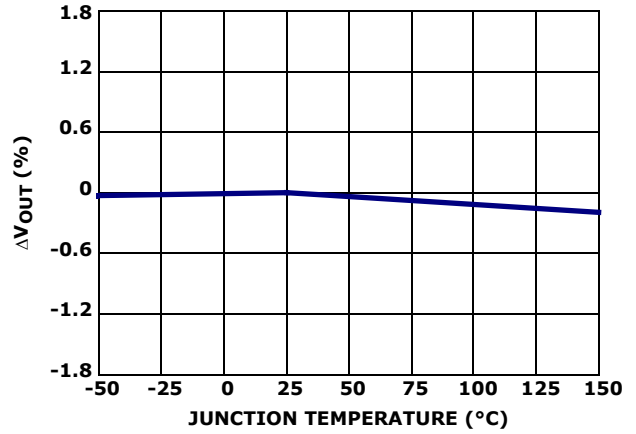

FIGURE 4. OUTPUT VOLTAGE vs TEMPERATURE

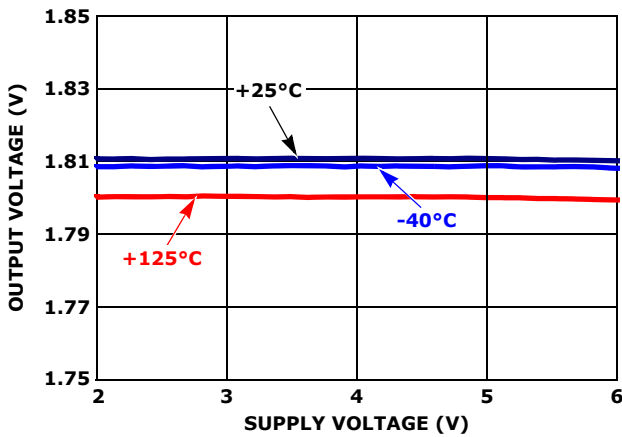

FIGURE 5. OUTPUT VOLTAGE vs INPUT VOLTAGE

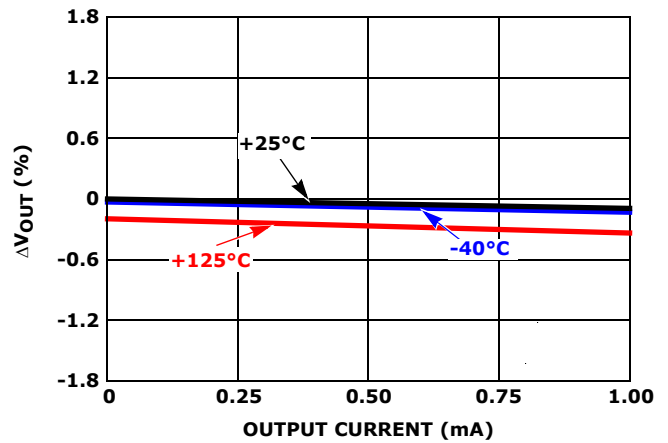

FIGURE 6. OUTPUT VOLTAGE vs LOAD CURRENT

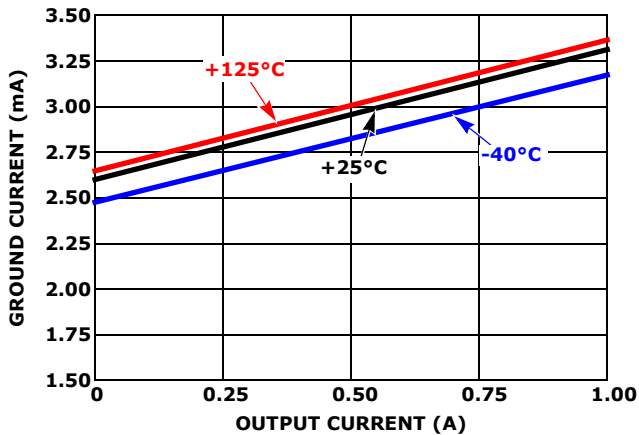

FIGURE 7. GROUND CURRENT vs LOAD CURRENT

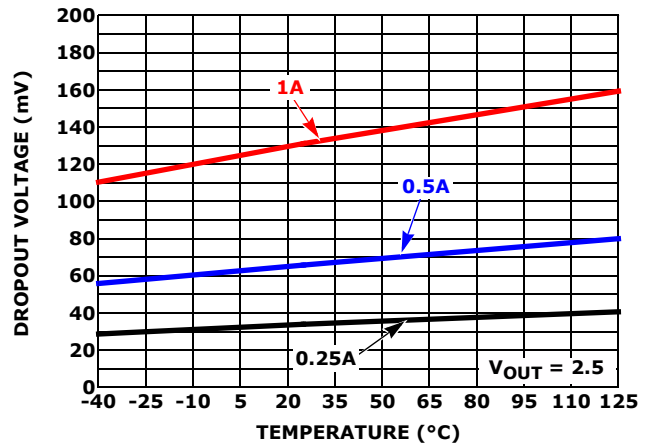

FIGURE 8. DROPOUT AT 1A vs TEMPERATURE

Typical Performance Curves

Unless otherwise specified, $V_{IN} = V_{OUT} + 0.4V$, $V_{OUT} = 1.8V$, $C_{IN} = C_{OUT} = 10\mu F$, $T_J = +25^\circ C$, $I_{LOAD} = 0A$ (Continued)

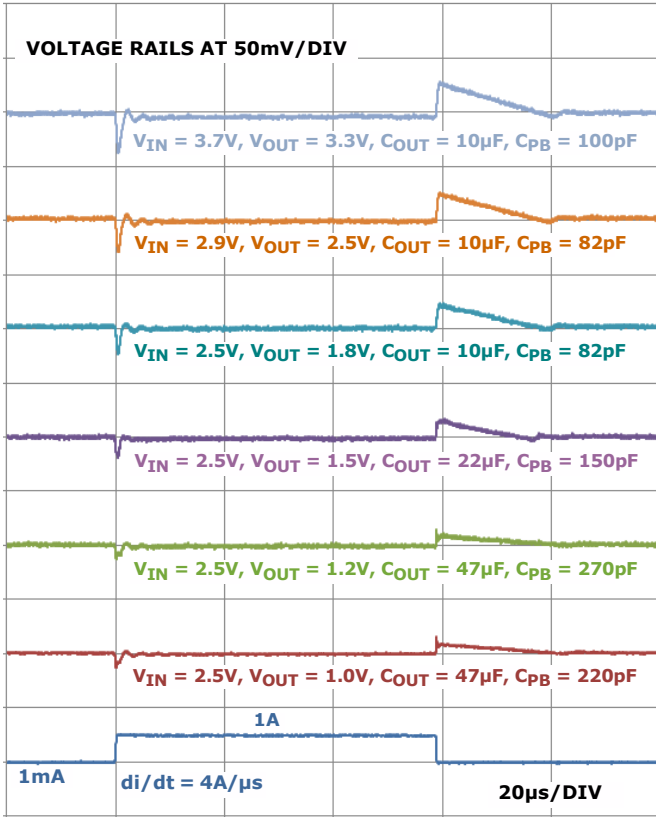

FIGURE 9. LOAD TRANSIENT WAVEFORMS

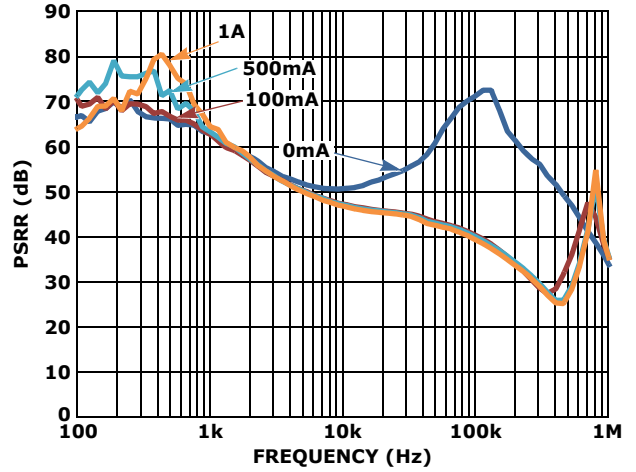

FIGURE 10. $V_{IN} = 2.5V$, $V_{OUT} = 1.0V$, $C_{OUT} = 47\mu F$, $C_{PB} = 220pF$

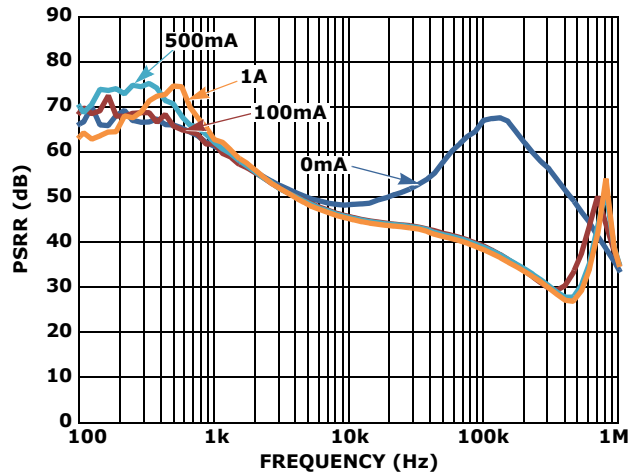

FIGURE 11. $V_{IN} = 2.5V$, $V_{OUT} = 1.2V$, $C_{OUT} = 47\mu F$, $C_{PB} = 270pF$

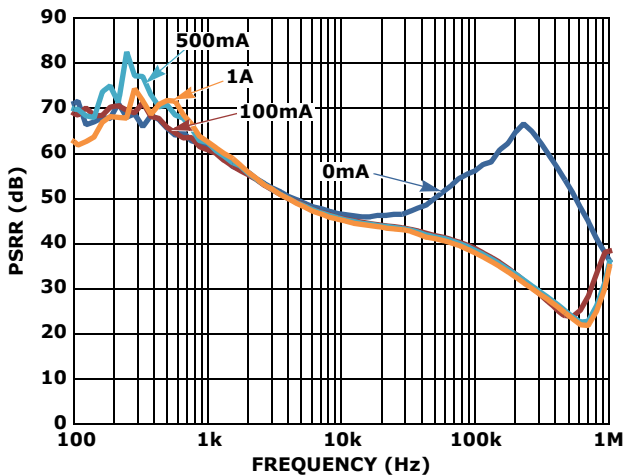

FIGURE 12. $V_{IN} = 2.5V$, $V_{OUT} = 1.2V$, $C_{OUT} = 22\mu F$, $C_{PB} = 120pF$

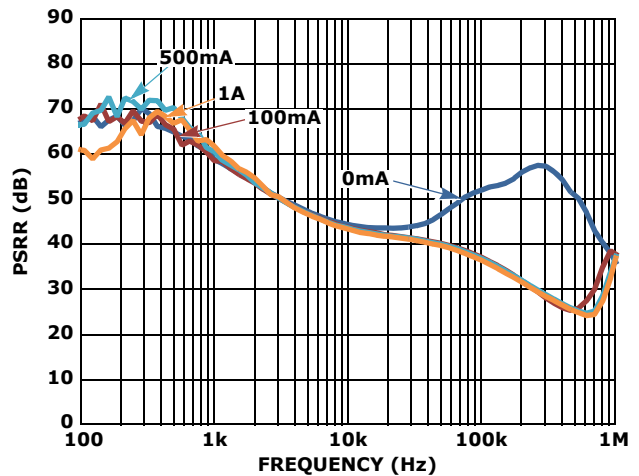

FIGURE 13. $V_{IN} = 2.5V$, $V_{OUT} = 1.5V$, $C_{OUT} = 22\mu F$, $C_{PB} = 150pF$

Typical Performance Curves

Unless otherwise specified, $V_{IN} = V_{OUT} + 0.4V$, $V_{OUT} = 1.8V$, $C_{IN} = C_{OUT} = 10\mu F$, $T_J = +25^\circ C$, $I_{LOAD} = 0A$ (Continued)

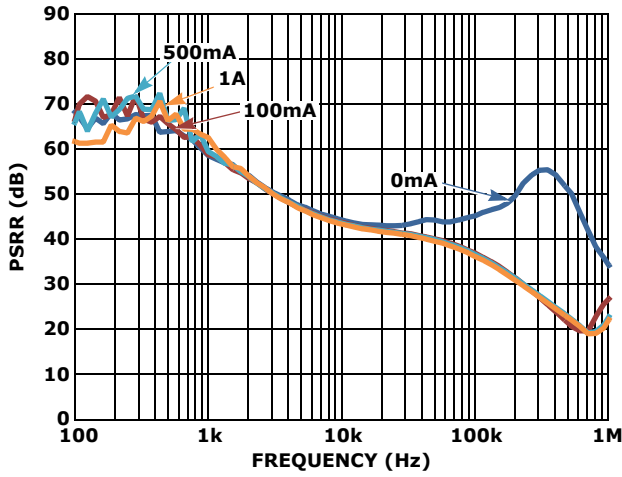

FIGURE 14. $V_{IN} = 2.5V$, $V_{OUT} = 1.5V$, $C_{OUT} = 10\mu F$, $C_{PB} = 68pF$

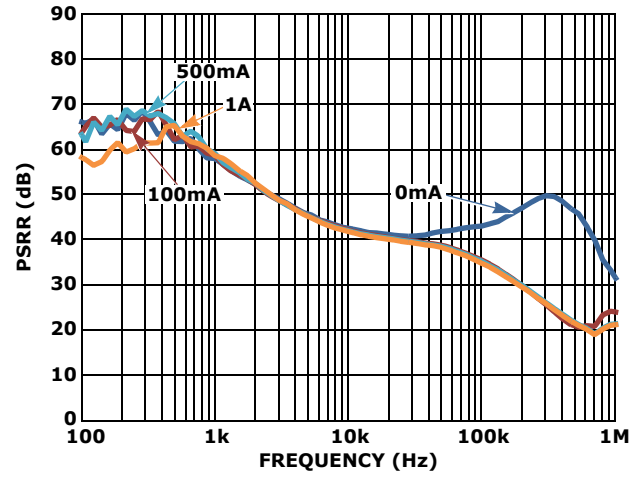

FIGURE 15. $V_{IN} = 2.5V$, $V_{OUT} = 1.8V$, $C_{OUT} = 10\mu F$, $C_{PB} = 82pF$

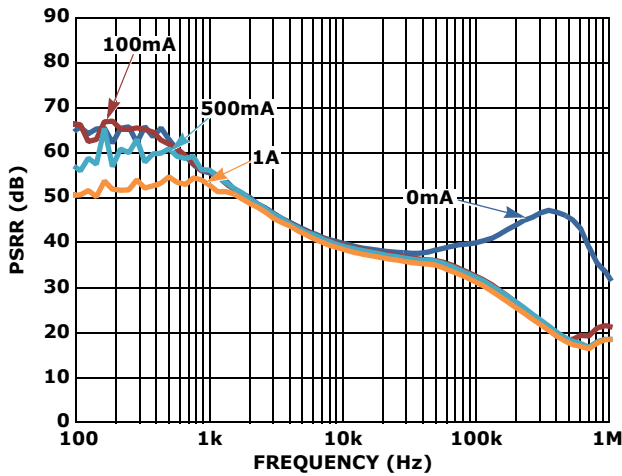

FIGURE 16. $V_{IN} = 2.9V$, $V_{OUT} = 2.5V$, $C_{OUT} = 10\mu F$, $C_{PB} = 82pF$

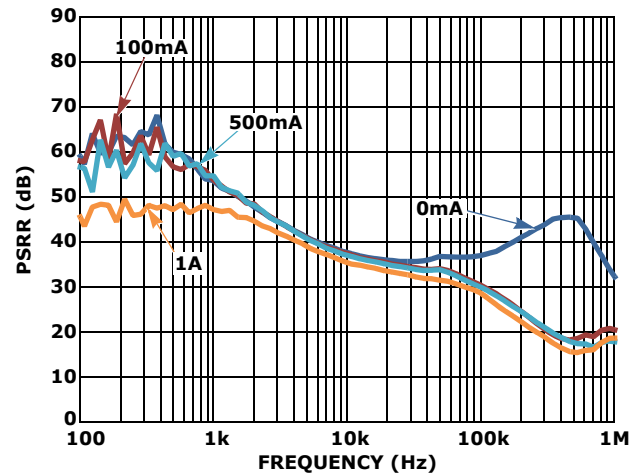
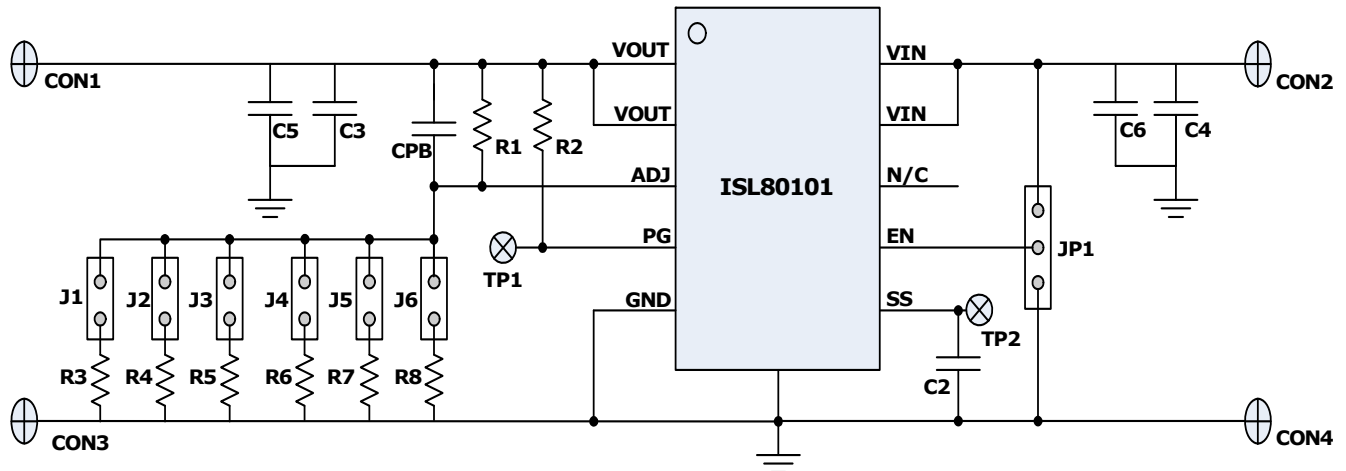

FIGURE 17. $V_{IN} = 3.7V$, $V_{OUT} = 3.3V$, $C_{OUT} = 10\mu F$, $C_{PB} = 100pF$

Schematic



Bill of Materials

ITEM	QTY	REFERENCE DESIGNATOR	VALUE	DESCRIPTION	MANUFACTURER	PART NUMBER
1	2	C5, C6	10µF	CAP, SMD, 0805, 16V, 10%,	Generic	
2	1	CPB	82pF	CAP, SMD, 0603	Generic	
3	1	U1		ISL80101IRAJZ	Intersil	ISL80101IRAJZ
4	1	R1	2.61kΩ	RES, SMD, 0603, 1%	Generic	
5	1	R2	100kΩ	RES, SMD, 0603, 1%	Generic	
6	1	R3	1kΩ	RES, SMD, 0603, 1%	Generic	
7	1	R4	464Ω	RES, SMD, 0603, 1%	Generic	
8	1	R5	1.3kΩ	RES, SMD, 0603, 1%	Generic	
9	1	R6	1.87kΩ	RES, SMD, 0603, 1%	Generic	
10	1	R7	2.61kΩ	RES, SMD, 0603, 1%	Generic	
11	1	R8	649Ω	RES, SMD, 0603, 1%	Generic	
12	1	JP1		Jumper	Generic	
13	6	J1, J2, J3, J4, J5, J6		Jumper	Generic	
14	1	TP1		Test Point	Keystone	5007
15	4	CON1, CON2, CON3, CON4		Terminal Connector	Keystone	1514-2
		C2, C3, C4, TP2		DNP		

NOTE: Available fixed versions of the ISL80101 will be sampled in an accompanying kit. Certain fixed versions will be available at a later date.

ISL80101EVAL2Z Evaluation Board Layout

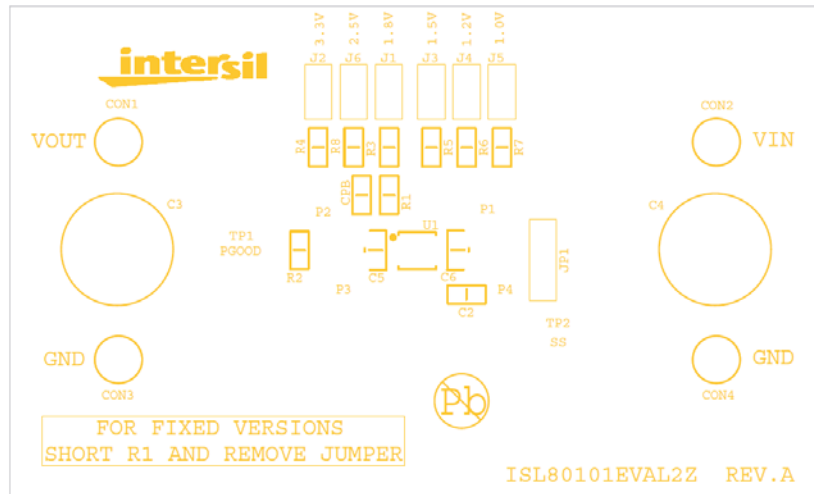

FIGURE 18. ISL80101EVAL2Z COMPONENT PLACEMENT

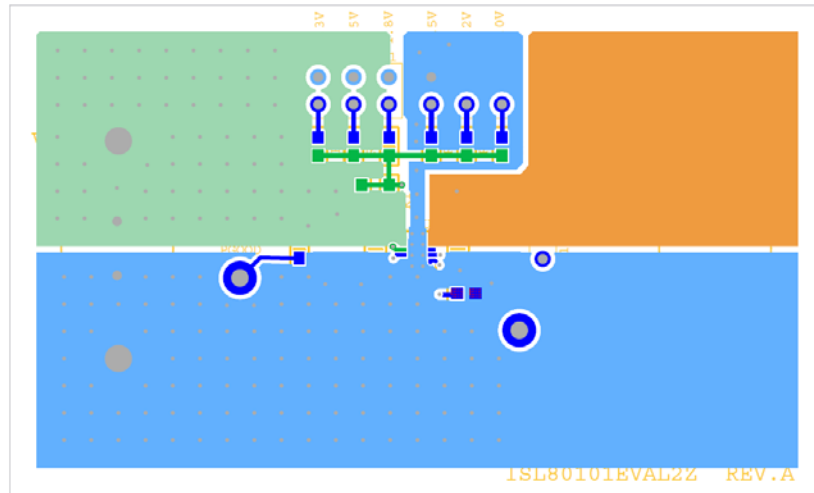

FIGURE 19. ISL80101EVAL2Z TOP LAYER

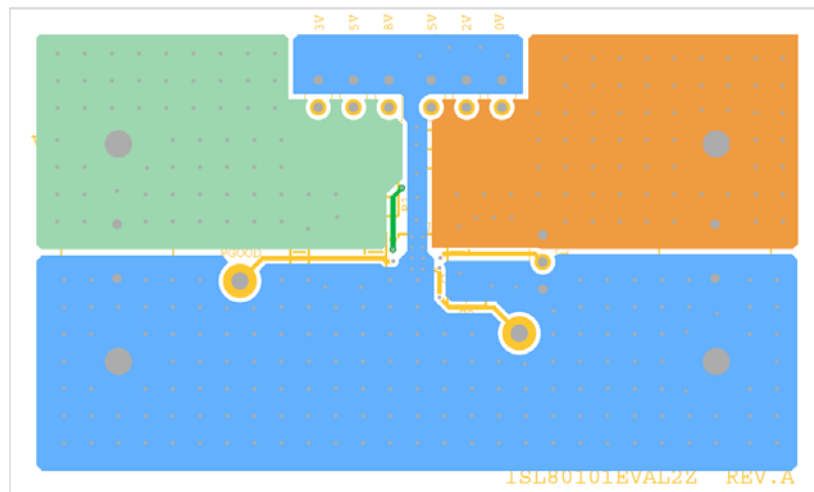

FIGURE 20. ISL80101EVAL2Z BOTTOM LAYER

Notice

1. Descriptions of circuits, software and other related information in this document are provided only to illustrate the operation of semiconductor products and application examples. You are fully responsible for the incorporation or any other use of the circuits, software, and information in the design of your product or system. Renesas Electronics disclaims any and all liability for any losses and damages incurred by you or third parties arising from the use of these circuits, software, or information.
2. Renesas Electronics hereby expressly disclaims any warranties against and liability for infringement or any other claims involving patents, copyrights, or other intellectual property rights of third parties, by or arising from the use of Renesas Electronics products or technical information described in this document, including but not limited to, the product data, drawings, charts, programs, algorithms, and application examples.
3. No license, express, implied or otherwise, is granted hereby under any patents, copyrights or other intellectual property rights of Renesas Electronics or others.
4. You shall not alter, modify, copy, or reverse engineer any Renesas Electronics product, whether in whole or in part. Renesas Electronics disclaims any and all liability for any losses or damages incurred by you or third parties arising from such alteration, modification, copying or reverse engineering.
5. Renesas Electronics products are classified according to the following two quality grades: "Standard" and "High Quality". The intended applications for each Renesas Electronics product depends on the product's quality grade, as indicated below.
"Standard": Computers; office equipment; communications equipment; test and measurement equipment; audio and visual equipment; home electronic appliances; machine tools; personal electronic equipment; industrial robots; etc.
"High Quality": Transportation equipment (automobiles, trains, ships, etc.); traffic control (traffic lights); large-scale communication equipment; key financial terminal systems; safety control equipment; etc.
Unless expressly designated as a high reliability product or a product for harsh environments in a Renesas Electronics data sheet or other Renesas Electronics document, Renesas Electronics products are not intended or authorized for use in products or systems that may pose a direct threat to human life or bodily injury (artificial life support devices or systems; surgical implantations; etc.), or may cause serious property damage (space system; undersea repeaters; nuclear power control systems; aircraft control systems; key plant systems; military equipment; etc.). Renesas Electronics disclaims any and all liability for any damages or losses incurred by you or any third parties arising from the use of any Renesas Electronics product that is inconsistent with any Renesas Electronics data sheet, user's manual or other Renesas Electronics document.
6. When using Renesas Electronics products, refer to the latest product information (data sheets, user's manuals, application notes, "General Notes for Handling and Using Semiconductor Devices" in the reliability handbook, etc.), and ensure that usage conditions are within the ranges specified by Renesas Electronics with respect to maximum ratings, operating power supply voltage range, heat dissipation characteristics, installation, etc. Renesas Electronics disclaims any and all liability for any malfunctions, failure or accident arising out of the use of Renesas Electronics products outside of such specified ranges.
7. Although Renesas Electronics endeavors to improve the quality and reliability of Renesas Electronics products, semiconductor products have specific characteristics, such as the occurrence of failure at a certain rate and malfunctions under certain use conditions. Unless designated as a high reliability product or a product for harsh environments in a Renesas Electronics data sheet or other Renesas Electronics document, Renesas Electronics products are not subject to radiation resistance design. You are responsible for implementing safety measures to guard against the possibility of bodily injury, injury or damage caused by fire, and/or danger to the public in the event of a failure or malfunction of Renesas Electronics products, such as safety design for hardware and software, including but not limited to redundancy, fire control and malfunction prevention, appropriate treatment for aging degradation or any other appropriate measures. Because the evaluation of microcomputer software alone is very difficult and impractical, you are responsible for evaluating the safety of the final products or systems manufactured by you.
8. Please contact a Renesas Electronics sales office for details as to environmental matters such as the environmental compatibility of each Renesas Electronics product. You are responsible for carefully and sufficiently investigating applicable laws and regulations that regulate the inclusion or use of controlled substances, including without limitation, the EU RoHS Directive, and using Renesas Electronics products in compliance with all these applicable laws and regulations. Renesas Electronics disclaims any and all liability for damages or losses occurring as a result of your noncompliance with applicable laws and regulations.
9. Renesas Electronics products and technologies shall not be used for or incorporated into any products or systems whose manufacture, use, or sale is prohibited under any applicable domestic or foreign laws or regulations. You shall comply with any applicable export control laws and regulations promulgated and administered by the governments of any countries asserting jurisdiction over the parties or transactions.
10. It is the responsibility of the buyer or distributor of Renesas Electronics products, or any other party who distributes, disposes of, or otherwise sells or transfers the product to a third party, to notify such third party in advance of the contents and conditions set forth in this document.
11. This document shall not be reprinted, reproduced or duplicated in any form, in whole or in part, without prior written consent of Renesas Electronics.
12. Please contact a Renesas Electronics sales office if you have any questions regarding the information contained in this document or Renesas Electronics products.
(Note 1) "Renesas Electronics" as used in this document means Renesas Electronics Corporation and also includes its directly or indirectly controlled subsidiaries.
(Note 2) "Renesas Electronics product(s)" means any product developed or manufactured by or for Renesas Electronics.

(Rev.4.0-1 November 2017)



SALES OFFICES

Renesas Electronics Corporation

<http://www.renesas.com>

Refer to "<http://www.renesas.com/>" for the latest and detailed information.

Renesas Electronics America Inc.
1001 Murphy Ranch Road, Milpitas, CA 95035, U.S.A.
Tel: +1-408-432-8888, Fax: +1-408-434-5351

Renesas Electronics Canada Limited
9251 Yonge Street, Suite 8309 Richmond Hill, Ontario Canada L4C 9T3
Tel: +1-905-237-2004

Renesas Electronics Europe Limited
Dukes Meadow, Millboard Road, Bourne End, Buckinghamshire, SL8 5FH, U.K
Tel: +44-1628-651-700, Fax: +44-1628-651-804

Renesas Electronics Europe GmbH
Arcadiastrasse 10, 40472 Düsseldorf, Germany
Tel: +49-211-6503-0, Fax: +49-211-6503-1327

Renesas Electronics (China) Co., Ltd.
Room 1709 Quantum Plaza, No.27 ZhichunLu, Haidian District, Beijing, 100191 P. R. China
Tel: +86-10-8235-1155, Fax: +86-10-8235-7679

Renesas Electronics (Shanghai) Co., Ltd.
Unit 301, Tower A, Central Towers, 555 Langao Road, Putuo District, Shanghai, 200333 P. R. China
Tel: +86-21-2226-0888, Fax: +86-21-2226-0999

Renesas Electronics Hong Kong Limited
Unit 1601-1611, 16/F., Tower 2, Grand Century Place, 193 Prince Edward Road West, Mongkok, Kowloon, Hong Kong
Tel: +852-2265-6688, Fax: +852-2886-9022

Renesas Electronics Taiwan Co., Ltd.
13F, No. 363, Fu Shing North Road, Taipei 10543, Taiwan
Tel: +886-2-8175-9600, Fax: +886-2-8175-9670

Renesas Electronics Singapore Pte. Ltd.
80 Bendemeer Road, Unit #06-02 Hyflux Innovation Centre, Singapore 339949
Tel: +65-6213-0200, Fax: +65-6213-0300

Renesas Electronics Malaysia Sdn.Bhd.
Unit 1207, Block B, Menara Amcorp, Amcorp Trade Centre, No. 18, Jln Persiaran Barat, 46050 Petaling Jaya, Selangor Darul Ehsan, Malaysia
Tel: +60-3-7955-9390, Fax: +60-3-7955-9510

Renesas Electronics India Pvt. Ltd.
No.777C, 100 Feet Road, HAL 2nd Stage, Indiranagar, Bangalore 560 038, India
Tel: +91-80-67208700, Fax: +91-80-67208777

Renesas Electronics Korea Co., Ltd.
17F, KAMCO Yangjae Tower, 262, Gangnam-daero, Gangnam-gu, Seoul, 06265 Korea
Tel: +82-2-558-3737, Fax: +82-2-558-5338