

SuperESD - PESD2CANFD24L-U-ES

1. Description

The PESD2CANFD24L-U-ES is Transient Voltage Suppressor that designed to protect components which are connected to data and transmission lines against electrostatic discharge (ESD), electrical fast transient (EFT), and lightning. All pins are rated to withstand 15kV ESD pulses using the IEC61000-4-2 air discharge method.

2. Features

- IEC 61000-4-2 Level 4 ESD Protection
 - $\pm 15\text{kV}$ Contact Discharge
 - $\pm 15\text{kV}$ Air Discharge
- 220W Peak pulse Power (8/20us)
- Low clamping voltage
- Working voltage: 24V
- Low leakage current
- RoHS compliant
- Protecting two bi-directional lines
- Junction capacitance: 10pF Typ.

3. Applications

- Control & monitoring systems
- Portable electronics
- Servers, notebooks, and desktop PCs
- Set-top box
- Communication systems

4. Ordering Information

| Part Number | Package | Marking | Material | Packing | Quantity per reel | Flammability Rating | Reel Size |
|--------------------|---------|---------|--------------|-------------|-------------------|---------------------|-----------|
| PESD2CANFD24L-U-ES | SOT-323 | T24 | Halogen free | Tape & Reel | 3,000 PCS | UL 94V-0 | 7 inches |

Table-1 Ordering information

5. Pin Configuration and Functions

| Pin | Name | Description | Outline | Circuit Diagram |
|-----|------|----------------|---|---|
| 1 | IO1 | Connect to IO |  |  |
| 2 | IO2 | Connect to IO | | |
| 3 | GND | Connect to GND | | |

Table-2 Pin configuration

6. Specification

6.1. Absolute Maximum rating

Over operating free-air temperature range (unless otherwise noted)

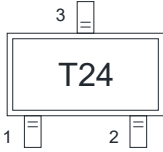
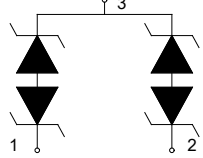
| Parameters | Symbol | Min. | Max. | Unit |
|--|------------------|------|------|------|
| Peak pulse power (tp=8/20us)@25°C | P _{pk} | - | 220 | W |
| Peak pulse current (tp=8/20us)@25°C | I _{PP} | | 4 | A |
| ESD (IEC61000-4-2 air discharge) @25°C | V _{ESD} | - | ± 15 | kV |
| ESD (IEC61000-4-2 contact discharge) @25°C | V _{ESD} | - | ± 15 | kV |
| Junction temperature | T _J | - | 150 | °C |
| Operating temperature | T _{OP} | -40 | 125 | °C |
| Storage temperature | T _{STG} | -55 | 150 | °C |
| Lead temperature | T _L | - | 260 | °C |

Table-3 Absolute Maximum rating

6.2. Electrical Characteristics

At TA = 25°C unless otherwise noted

| Parameter | Symbol | Conditions | Min. | Typ. | Max. | Units |
|---------------------------|-----------|---------------------------------|------|------|------|---------|
| Reverse Stand-off Voltage | V_{RWM} | | | | 24.0 | V |
| Reverse Breakdown Voltage | V_{BR} | $I_T=1mA$ | 26.0 | | | V |
| Reverse Leakage Current | I_R | $V_{RWM}=24V$ | | | 1.0 | μA |
| Clamping Voltage | V_C | $I_{PP}=1A$; $t_p=8/20\mu s$ | | 35.0 | 38.0 | V |
| Clamping Voltage | V_C | $I_{PP}=4A$; $t_p=8/20\mu s$ | | 45.0 | 48.0 | V |
| Junction Capacitance | C_J | I/O to GND; $V_R=0V$; $f=1MHz$ | | 10 | 15 | pF |

Table-4 Electrical Characteristics

| Symbol | Parameters |
|-----------|-------------------------------------|
| V_{RWM} | Peak Reverse Working Voltage |
| I_R | Reverse Leakage Current @ V_{RWM} |
| V_{BR} | Breakdown Voltage @ I_T |
| I_T | Test Current |
| I_{PP} | Maximum Reverse Peak Pulse Current |
| V_C | Clamping Voltage @ I_{PP} |

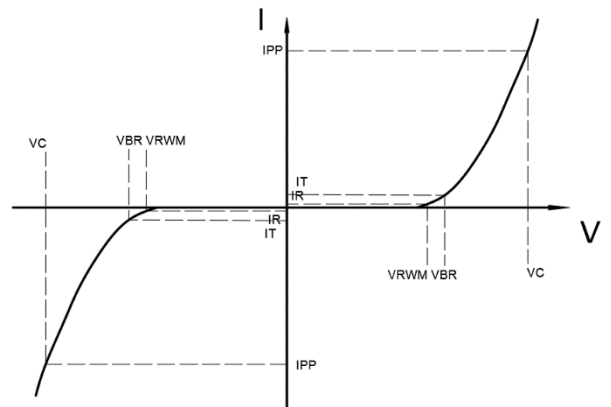

7. Typical Characteristic

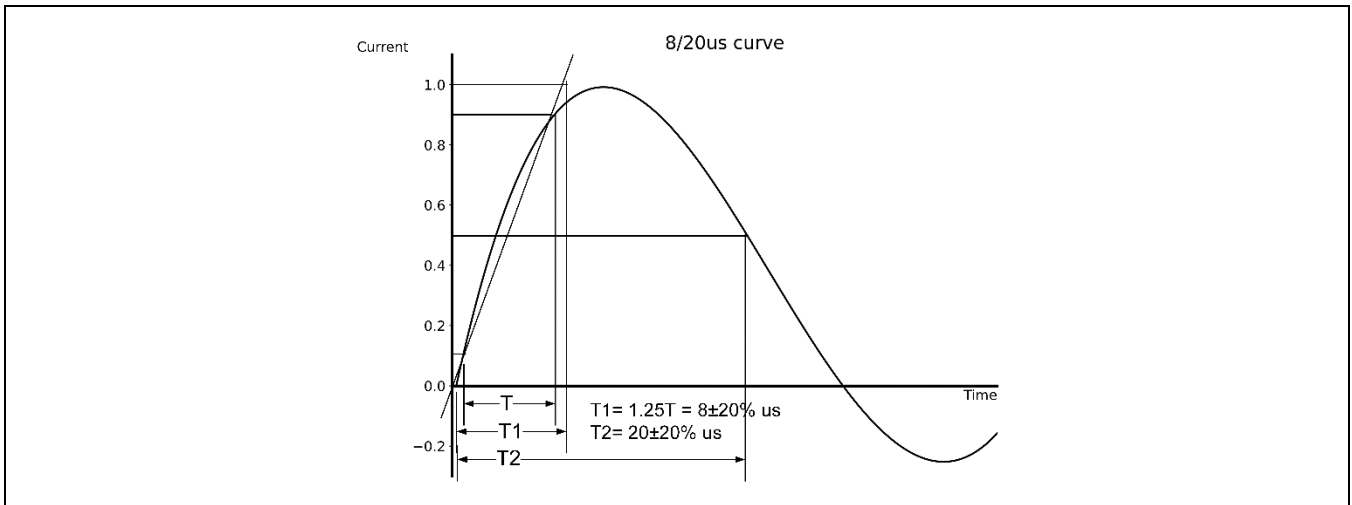

8. Typical Application

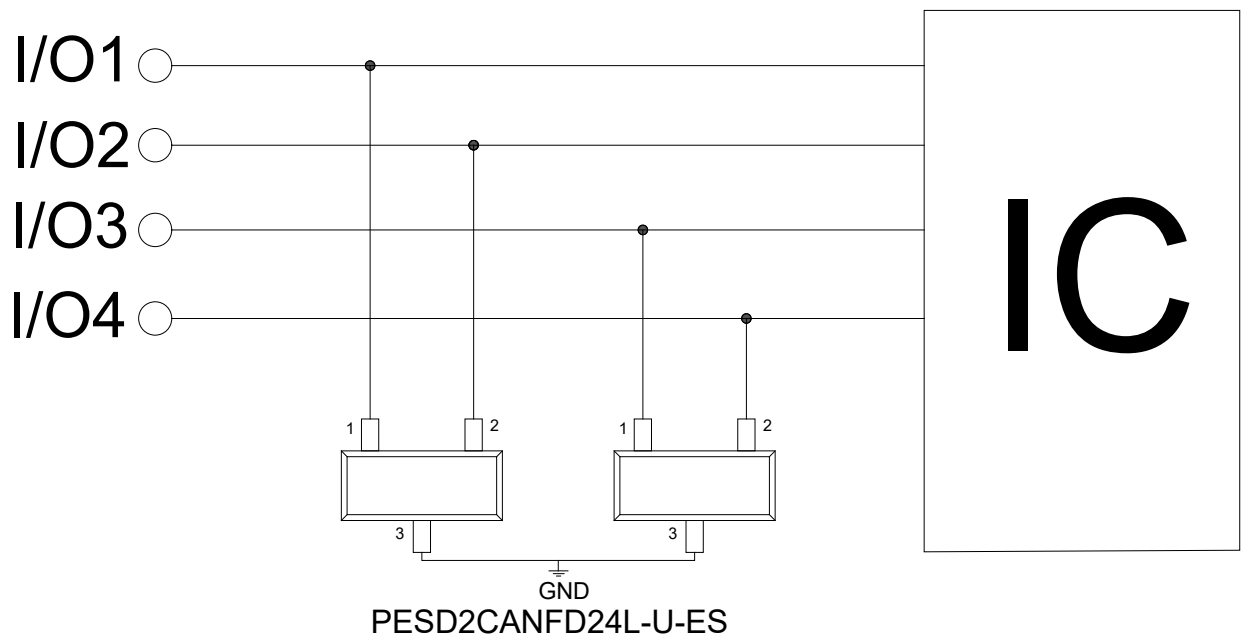

Typical Interface Application

9. Dimension (SOT-323)

POD(Z)

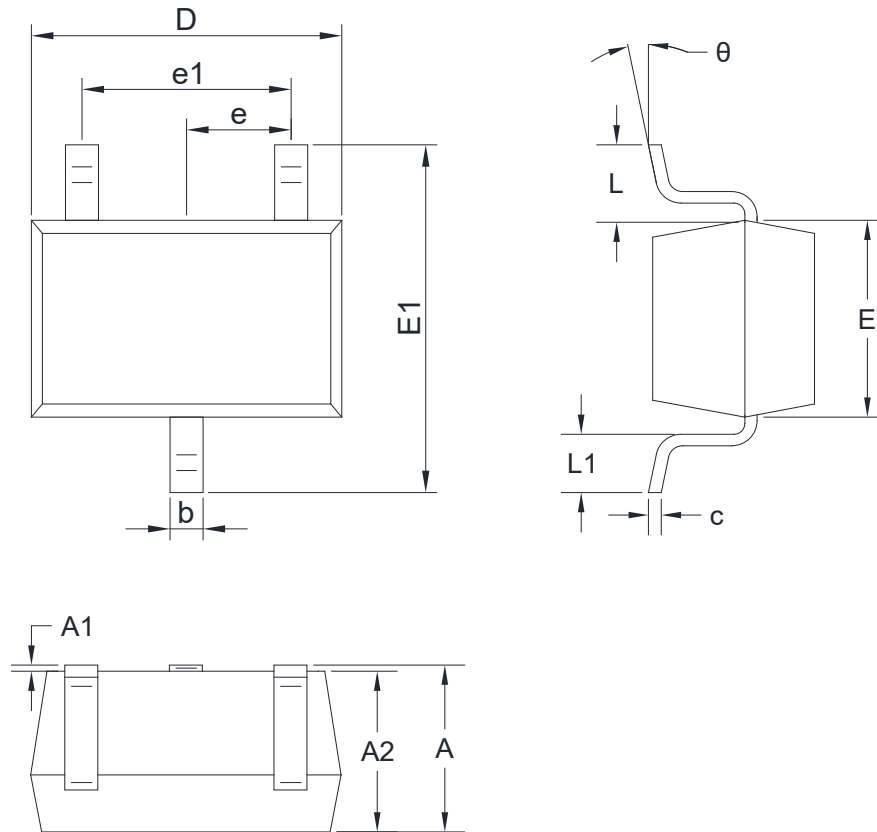

| Symbol | Millimeters | | Symbol | Millimeters | |
|--------|-------------|------|----------|-------------|------|
| | Min | Max | | Min | Max |
| A | 0.80 | 1.00 | E1 | 2.05 | 2.35 |
| A1 | 0.00 | 0.10 | e | 0.65 TYP | |
| A2 | 0.80 | 0.90 | e1 | 1.20 | 1.40 |
| b | 0.20 | 0.40 | L | 0.45 REF | |
| c | 0.08 | 0.15 | L1 | 0.26 | 0.46 |
| D | 2.00 | 2.20 | θ | 0° | 8° |
| E | 1.15 | 1.35 | | | |

10. Recommended Soldering Footprint

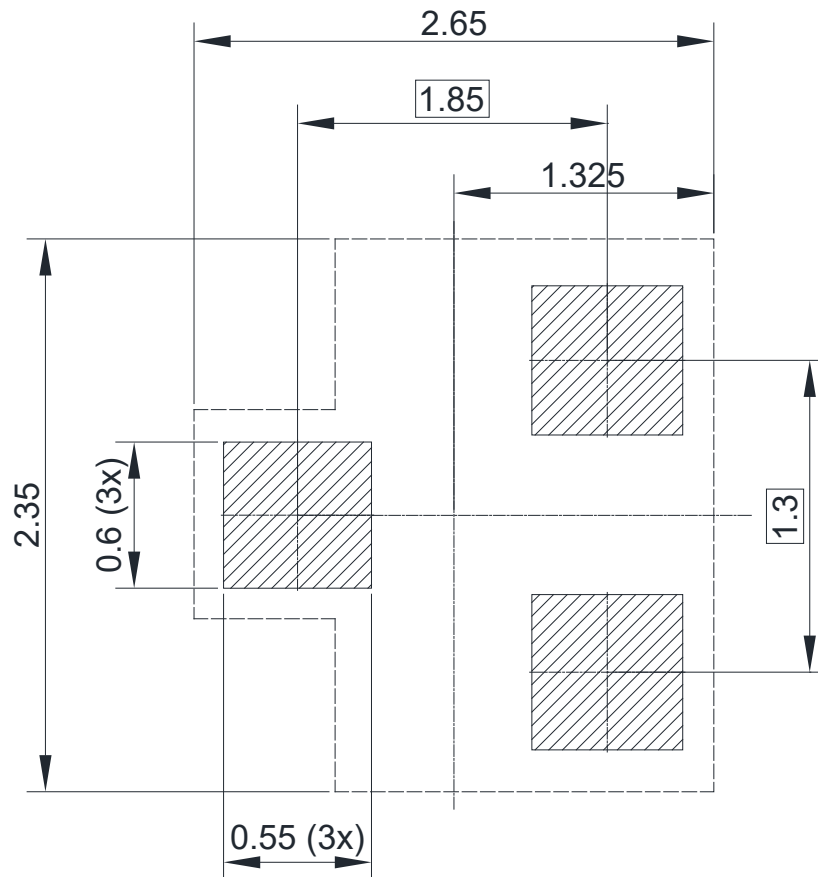

DIMENSIONS: MILLIMETERS

DISCLAIMER

ELECSUER PROVIDES TECHNICAL AND RELIABILITY DATA (INCLUDING DATASHEETS), DESIGN RESOURCES (INCLUDING REFERENCE DESIGNS), APPLICATION OR OTHER DESIGN ADVICE, SAFETY INFORMATION, AND OTHER RESOURCES "AS IS" AND WITH ALL FAULTS, AND DISCLAIMS ALL WARRANTIES, EXPRESS AND IMPLIED, INCLUDING WITHOUT LIMITATION ANY IMPLIED WARRANTIES OF MERCHANTABILITY, FITNESS FOR A PARTICULAR PURPOSE OR NON-INFRINGEMENT OF THIRD PARTY INTELLECTUAL PROPERTY RIGHTS.

These resources are intended for skilled developers designing with ElecSuper products. You are solely responsible for

- (1) selecting the appropriate ElecSuper products for your application;
- (2) designing, validating and testing your application;
- (3) ensuring your application meets applicable standards, and any other safety, security, or other requirements.

These resources are subject to change without notice. ElecSuper grants you permission to use these resources only for development of an application that uses the ElecSuper products described in the resource. Other reproduction and display of these resources are prohibited. No license is granted to any other ElecSuper intellectual property right or to any third party intellectual property right. ElecSuper disclaims responsibility for, and you will fully indemnify ElecSuper and its representatives against, any claims, damages, costs, losses, and liabilities arising out of your use of these resources. ElecSuper's products are provided subject to ElecSuper's Terms of Sale or other applicable terms available either on www.elecsuper.com or provided in conjunction with such ElecSuper products. ElecSuper's provision of these resources does not expand or otherwise alter ElecSuper's applicable warranties or warranty disclaimers for ElecSuper products.