



产品规格书

产品名称：发光二极管贴片

Product Name: Light emitting diode patch

产品型号：GL2835UB01 蓝灯 0.2w 铜支架
缺口负 负极朝孔

Product model: 2835 Blue light

发布日期：2023 年 5 月

Release date: May 2023



环保产品，符合 ROHS 要求

Environmental protection products meet ROHS requirements

湿气敏感性等级 (MSL) :4-5 级

Moisture sensitivity level (MSL) : 4-5 levels

EIA 规范标准包装

EIA standard packaging

使用寿命长

long service life

高能效、启动快

High energy efficiency, fast startup

低电压有流驱动

Low voltage current drives



目录 (catalogue)

1: 应用领域.....	3
Application area	
2: 外观与尺寸.....	4
Appearance and size	
3: 电性参数.....	5, 6,
Electrical parameters	
4: 可靠性实验.....	7
Reliability experiment	
5: 包装与标签说明.....	8
Packaging and labeling instructions	
6: 焊接指导.....	9
Welding guidance	
7: 使用包装注意事项.....	10, 11, 12
Precautions for using packaging	

公司名称: 广西桂光半导体有限公司

公司网址: www.guiguanglight.com

公司地址: 广西壮族自治区崇左市扶绥县新宁镇空港大道 46 号青年创业基地 4 号楼厂房



一、应用领域 Application area

- * 汽车照明
Automotive lighting
- * 室内照明
Indoor lighting
- * 商业照明
Commercial lighting
- * 家电、数码
Home appliances, digital
- * 节日灯饰
Festival lighting fixtures
- * 广告应用
Advertising application
- * 健康医疗
Health and Medical Care
- * 电子教学设备
Electronic teaching equipment
- * 城市亮化
Urban lighting





二、外观与尺寸 Appearance and size

- 1、外观尺寸/ Package (L/W/H) : 2.8*3.5*0.8 mm
- 2、颜色/ Color: 超亮蓝光/ Ultra Bright Standard Blue
- 3、胶体/ Lens: 清水平模/ Water Clear Flat Mold
- 4、用于自动贴片机/Compatible With SMT Automatic Equipment
- 5、适用于红外线回流焊制程/Compatible With Infrared Reflow Solder Process

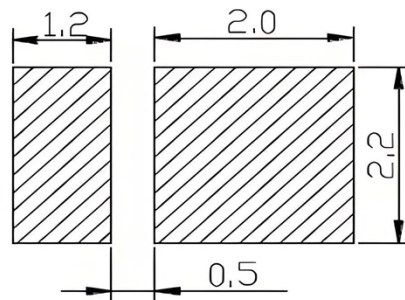
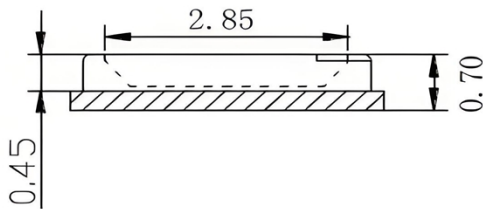
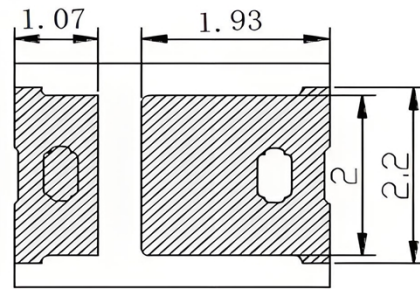
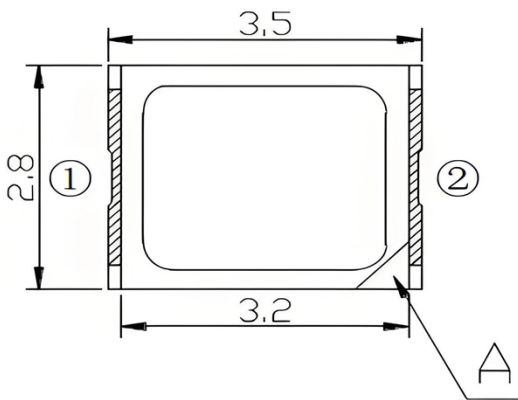

推荐焊盘
Recommended Soldering Pad

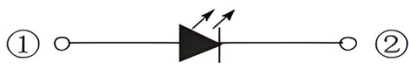

极性 Polarity

Note:

A: 缺口标志

A: Nick Mark

备注 (Note):

1. 所有尺寸均以 mm 为单位;
All dimensions are in millimeters
2. 在没有明确标注的情况下, 公差均为 $\pm 0.1\text{mm}$.
In the absence of clear markings, the tolerance is $\pm 0.1\text{mm}$



三、电性参数 Electrical parameters

1、最大绝对标称值 (环境温度=25° C)

Maximum absolute nominal value (Environmental temperature=25 ° C)

参数/parameter	缩写/abbreviation	标称值/ Nominal value	单位/ unit
正向电流 forward current	I_F	60	mA
正向峰值电流 *1 Forward peak current * 1	I_{FP}	100	mA
反向电压 Reverse voltage	VR	5	V
焊接温度 welding temperature	Tsol	回流焊/ Reflow Soldering: 260 ° C, 5sec. 手工焊/ manual welding: 300 ° C, 3sec.	
使用温度 Usage temperature	Topr	-30° C ~ +85	
储存温度 storage temperature	Tstg	-40° C ~ +90	

* I_{FP} 条件: 脉宽 ≤ 0.1msec, 周期 ≤ 1/10

*IFP condition: Pulse width ≤ 0.1msec, cycle ≤ 1/1

2、光电特性参数 (环境温度=25° C)

Optoelectronic characteristic parameters (ambient temperature=25 ° C)

参数 parameter	缩写 abbreviation	最小值 minimum value	典型值 Typical values	最大值 Maximum value	单位 unit	条件 condition
正向电压 forward voltage	Vf	2.8	3.2	3.6	V	IF=60mA
亮度 brightness	Iv	3	4	6	Lm	IF=60mA
波长 wavelength	λ_d	450	460	475	nm	IF=60mA
谱线半宽 Spectral Line Half-Width	$\Delta \lambda$	-	25	-	nm	IF=60mA
发光角度 viewing angle	2 $\theta_{1/2}$	-	120	-	deg	IF=60mA
反向电流 reverse current	IR	-	-	5	μ A	VR=5V

备注 (Notes) :

亮度偏差: ±15% Brightness deviation: ±15%

电压偏差: ±0.1V Voltage deviation: ±0.1V

波长偏差: ±1nm Wavelength deviation: ±1nm



3、典型特性曲线

Typical characteristic curve

伏安特性
Volt-Ampere Characteristics

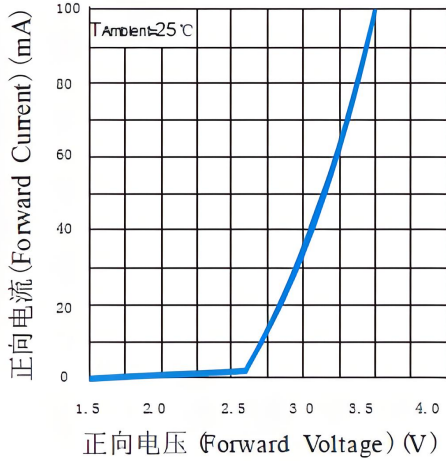

相对光强与正向电流特性
Relative Luminous Intensity VS Forward Current

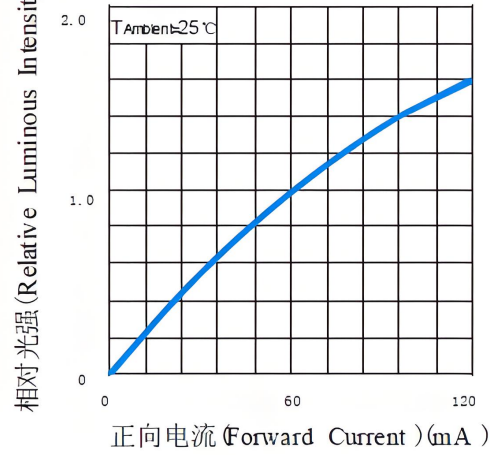

正向电流降额曲线
Forward Current Derating Curve

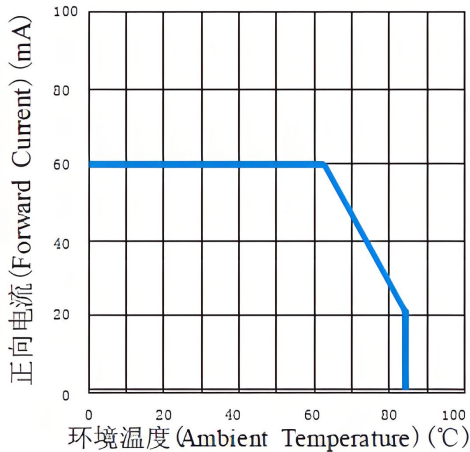

光强与环境温度曲线
Luminous Intensity VS Ambient Temperature

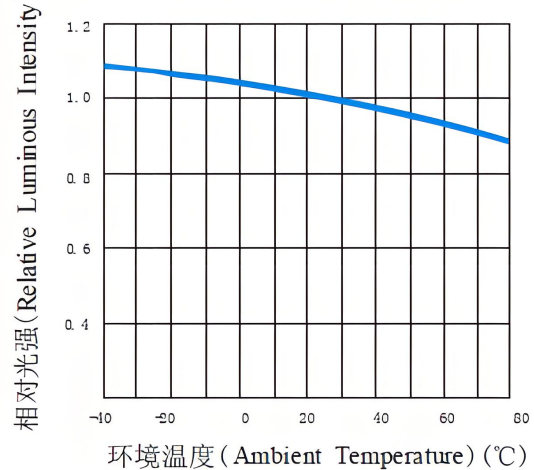

光谱分布特性曲线
Relative Spectral Distribution

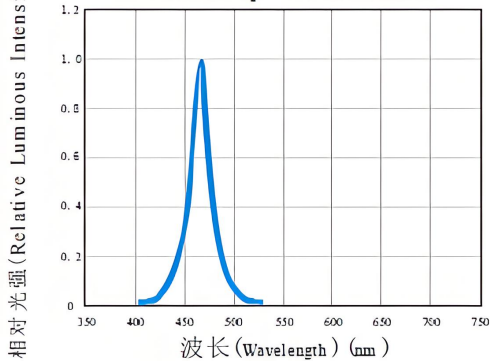

光强分布特性曲线
Typical Spatial Distribution

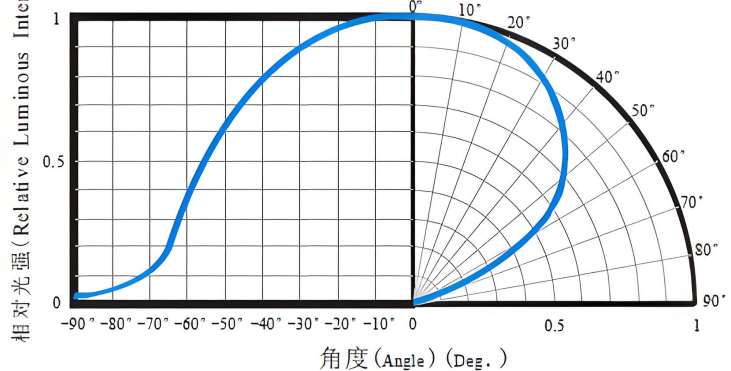

注

(Note) : 如无另外注明, 测试环境温度为 $25 \pm 5^\circ\text{C}$

Unless otherwise specified, the testing environment temperature is $25 \pm 5^\circ\text{C}$



四、可靠性试验 Reliability Test

序号 Serial Number	测试项目 Test project	测试条件 Test conditions	样品数量 Number of samples	允收/拒收 Accept/Reject
1	寿命实验 Life test	测试电流: 20mA Test current: 20mA 温度: 25° C Temperature: 25° C 测试时间: 1000 小时 Testing time: 1000 hours	20	0/1
2	高温高湿 (静态实验) High temperature and humidity (Static experiment)	温度: 等于 65° C Temperature: equal to 65° C 湿度: RH90% Humidity: RH90% 测试时间: 240 小时 Testing time: 240 hours	20	0/1
3	冷热冲击 Thermal Shock	-40° C~+100° C 20min 10s 20min 测试时间: 100 个循环 Test time: 100 cycles	20	0/1
4	高温储存 high temperature storage	高温: +100° C High temperature: + 100° C 测试时间: 1000 小时 Testing time: 1000 hours	20	0/1
5	低温储存 low temperature storage	低温: -40° C Low temperature: - 40° C 测试时间: 1000 小时 Testing time: 1000 hours	20	0/1
6	温度循环 Temperature cycling	-40° C~+100° C 30min 5min 30min 测试时间: 20 个循环 Testing time: 20 cycles	20	0/1
7	回流焊 Reflow Soldering	260° C (Max.), 最大不超过 10 秒钟 260° C (Max.), maximum not exceeding 10 seconds	20	0/1

可靠度实验不合格判定标准/ Criteria for determining the failure of reliability experiments

IV: 衰减超过 50%

IV: Attenuation exceeding 50%

VF: 变化超过 20%

VF: Changes exceeding 20%

备注 (Notes):

1. 同一项实验结果的测试需要在 2 个小时之内完成;

The testing of the same experimental result needs to be completed within 2 hours

2. 测试必须在每项实验完成后, 材料恢复正常环境条件下才能进行。

The testing can only be carried out after each experiment is completed and the material is restored to normal environmental conditions



五、包装与标签说明 Packaging and labeling instructions

裁带与圆盘尺寸 Cutting tape and disc size

包装数量: 4000 pcs/卷 (Packaging quantity: 4000 pcs/roll)

注 (pour) :

1. 尺寸单位为毫米(mm)。
The unit of measurement is millimeters (mm)
2. 尺寸公差是 $\pm 0.1\text{mm}$ 。
The dimensional tolerance is $\pm 0.1\text{mm}$.

包装方式: (单位: mm)

Packaging method: (Unit: mm)

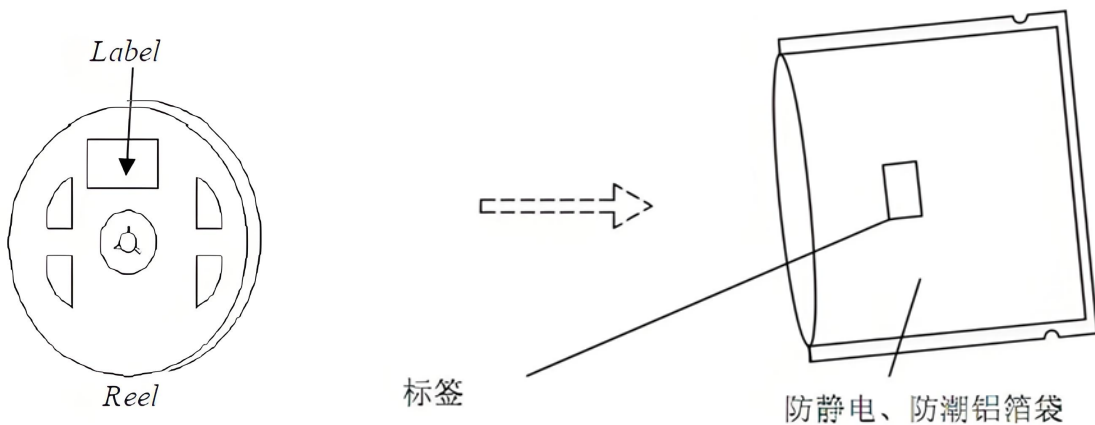

◆ 标签说明 (Label description)

LOT NO: 批次信息 (Batch Information)

PART NO: 产品型号 (PRODUCT MODEL)

BIN CODE: 产品名称 (product name)

WL: 波长范围 (wavelength range)

LV: 光强范围 (Light intensity range)

VF: 电压范围 (Voltage range)



六、焊接指导 Welding guidance

1、使用烙铁人手焊接

Hand soldering with a soldering iron

推荐使用功率低于 20W 的烙铁，焊接时烙铁的温度必须保持在 350℃ 以下，且每个电极只能进行一次焊接，每次焊接的持续时间不得超过 3 秒

人手焊接过程中的不慎操作易引起 LED 产品的损坏，应当小心谨慎。

It is recommended to use a soldering iron with a power of less than 20W. During soldering, the temperature of the soldering iron must be kept below 350 °C, and each electrode can only enter Perform welding once, and the duration of each welding should not exceed 3 seconds

Careless operation during manual welding can easily cause damage to LED products, and caution should be taken.

2、回流焊接：推荐使用以下无铅回流焊接温度图进行。

Reflow soldering: It is recommended to use the following lead-free reflow soldering temperature chart

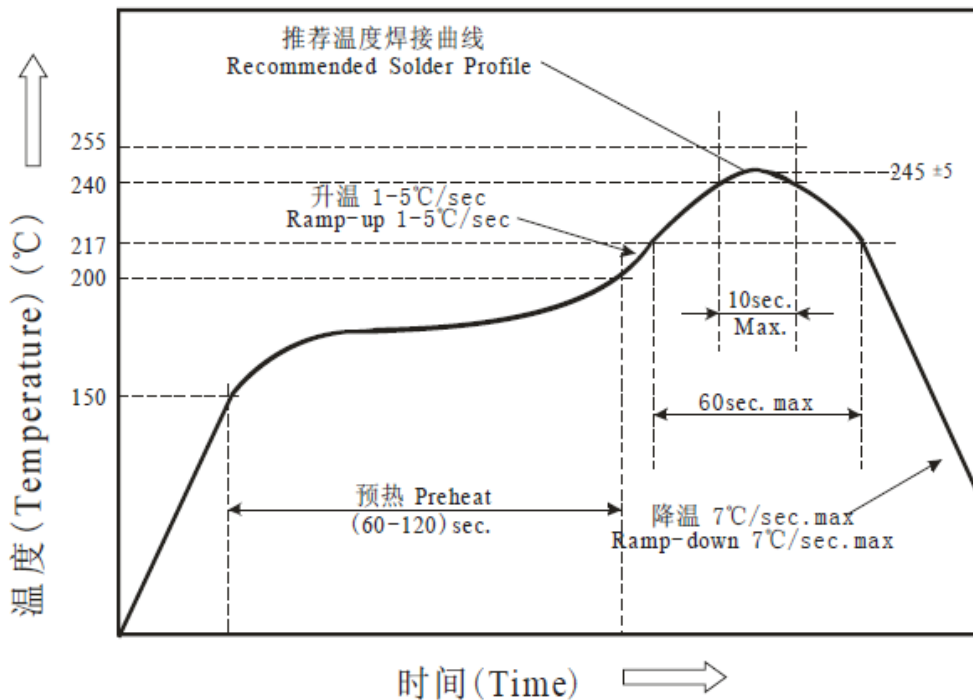

回流焊接最多只能进行两次。

Reflow soldering can only be performed twice at most.

在回流焊接升温过程中，请不要对 LED 施加任何压力。

Please do not apply any pressure to the LED during the reflow soldering heating process.

在焊接完成后，待产品温度下降到室温之后，再进行其他处理。

After welding is completed, wait for the product temperature to drop to room temperature before proceeding with other treatments.



七、使用注意事项 Precautions for use

1、清洗 clean

a. 不能用超声波清洗。建议使用异丙醇 (isopropyl alcohol)、纯酒精擦拭或浸渍，不要超过 1 分钟，在室温下放置 15 分钟再使用。清洗后，确保 LED 发光面干净，异物会影响发光颜色。

Ultrasonic cleaning is not allowed. It is recommended to wipe or soak with isopropyl alcohol or pure alcohol for no more than 1 minute, and let it sit at room temperature for 15 minutes before use. After cleaning, ensure that the LED emitting surface is clean, as foreign objects can affect the color of the light

b. 应避免接触或污染天那水，三氯乙烯、丙酮、硫化物、氮化物、酸、碱、盐类，这些物质会损伤 LED.

Avoid contact with or contamination of Tian Na water, trichloroethylene, acetone, sulfides, nitrides, acids, bases, and salts, as these substances can damage LEDs

2、灌封 Potting

a. 纳离子、硫化物会使荧光颜色变淡 (中毒)，灌封时，避免使用含纳离子、硫化物的灌封胶。

Nano ions and sulfides can cause the fluorescent color of Lou to become lighter (toxic). When sealing, avoid using sealing adhesives containing nano ions and sulfides

b. 使用正常灌封胶时，建议先以少量试验，常温点亮 168 小时，确定没有问题再作业。

When using normal sealant, it is recommended to conduct a small test first, light it up at room temperature for 168 hours, and confirm that there are no problems before starting work

3、保存 save

a. 打开包装前，LED 应存储在温度 30°C 或以下，相对湿度在 RH60% 以下，一年内使用。

Before opening the packaging, the LED should be stored at a temperature of 30 °C or below and a relative humidity of RH60% or below, and used within one year

b. 打开包装后，LED 应在温度 30°C 或以下、相对湿度在 RH30-35% 或更低环境下，使用时间 7 天。LED 吸潮后，回流焊时可能裂胶，影响发光颜色。对于未使用的散件，请去潮处理 (对于卷装品: 烘烤 60°C ±5°C, 12 小时; 对于散装品: 烘烤 105°C ±5°C, 1 小时)，然后再用铝箔袋密封后保存。

After opening the packaging, the LED should be used for 7 days in an environment with a temperature of 30°C or below and a relative humidity of RH30-35% or lower. After the LED absorbs moisture, it may crack during reflow soldering, affecting the color of the light emission. For unused loose parts, please remove moisture (for roll products: bake at 60°C±5°C for 12 hours; for bulk products: bake at 105°C±5°C for 1 hour), then seal with aluminum foil bag and store

c. 保存环境中避免有酸、碱以及腐蚀气体存在，同时避免强烈震动及强磁场作用。

Avoid the presence of acids, alkalis, and corrosive gases in the storage environment, while also avoiding strong vibrations and strong magnetic fields



4、静电 static electricity

a. 静电或峰值浪涌电压会损坏 LED, 避免在开灯、关灯时产生瞬时电压。

Static electricity or peak surge voltage can damage LEDs, avoiding the generation of instantaneous voltage when turning on or off lights

b. 建议使用 LED 时佩戴防静电手腕带、防静电手套, 穿防静电鞋, 使用的设备、仪器正确接地。LED 损坏后, 表现出漏电流明显增加, 低电流正向电压变低, 低电流点不亮等现象。

It is recommended to wear anti-static wrist straps, anti-static gloves, anti-static shoes when using LEDs, and ensure that the equipment and instruments used are properly grounded. After the LED is damaged, it shows a significant increase in leakage current, a decrease in forward voltage at low current, and the low current point does not light up

5、测试 test

a. LED 要在额定电流下驱动, 同时电路中需要加限流电阻保护, 否则, 轻微的电压变化就会引起较大的电流变化, 从而破坏 LED.

LEDs need to be driven at rated current, and current limiting resistors need to be added to the circuit for protection. Otherwise, slight voltage changes can cause significant current changes, which can damage the LED

b. 在电路导通或关闭情况下, 要避免瞬间浪涌电压的产生, 否则, LED 将被烧坏。

When the circuit is turned on or off, it is necessary to avoid the generation of transient surge voltage, otherwise the LED will be burned out.

c. 正向电压 V_F 过高或反向电压 V_R 过高, 均会损坏 LED.

Excessive forward voltage V_F or excessive reverse voltage V_R can damage the LED

d. 点亮或测试 LED 时, 加在 LED 两端的反向电压不得高于 5V, 否则容易击伤 LED.

When lighting or testing the LED, the reverse voltage applied to both ends of the LED should not exceed 5V, otherwise it is easy to damage the LED



6、其他 other

LED 发光颜色会随着工作电流不同而有少许变化，建议设计时考虑电阻与 LED 串联使用。点亮时，注意不要直视 LED 发光面，LED 的光强度会灼伤眼睛。

The color of LED light may vary slightly with different operating currents. It is recommended to consider using resistors in series with the LED during design. When lighting up, be careful not to look directly at the LED emitting surface, as the light intensity of the LED can burn the eyes

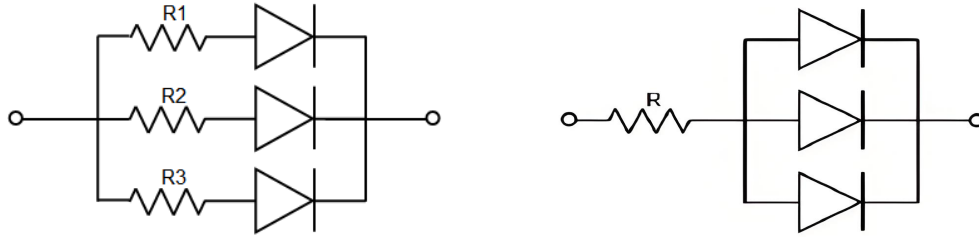

7、声明 The statement

选购桂光光电生产之产品即享有保质期内标准售后服务，详情请洽询我司相关销售人员，桂光光电有限公司保留最终决定处理方式的权利，相关保质服务仅限于桂光光电产品本体，恕不对客户端产品/系统等负担衍展性的责任(含直接及间接)。客户如未对产品进行规格和功能性验证及索取对应产品承认书（规格书）资料进行签署确认直接下单则视为默认此服务条款。

客户进货检验 IQC(Incoming Quality Control)、最终检验 FQC(Final Quality Control)、系统质量检验 SQC(System Quality Control)等不同阶段如有发现产品品质异常，请尽速与我司相关销售人员联系。经桂光光电技术人员分析结果，如可确认归责为我司产品瑕疵的，客户可与我司相关销售人员协商退货/换货/退款方式择一处理。合作中惟本条款与其它合约协议不一致的均以此条款为准。

Guiguang photoelectric production of choose and buy products that have standard warranty period after-sales service, for details, please inquire our relevant sales staff, Guiguang photoelectric co., LTD. Reserves the right to final decision approach is limited to ontology Guiguang photoelectric products, quality services related to tell wrong client product/system such as the responsibility of the burden of yan malleable (including direct and indirect). If the customer places an order directly without verifying the specifications and functionality of the product and signing the corresponding product acknowledgement document (specification), it will be deemed as a default of this service term.

Incoming Quality Control (IQC), Final Quality Control (FQC), System Quality Control (SQC) and other different stages of customer Incoming Quality Control (IQC), Incoming Quality Control (FQC), System Quality Control (SQC) Please contact our sales staff as soon as possible. According to the analysis result of Guiguang photoelectric technical personnel, if it can be confirmed that the fault is attributed to our company's product defects, the customer can negotiate with our company's relevant sales staff to choose a way to deal with the return/replacement/refund. In cooperation, this clause shall prevail if there is any inconsistency between this clause and other contractual agreements.

the luminous color. Heat dissipation should be fully considered in the design