

PLEASE CHECK WWW.MOLEX.COM FOR LATEST PART INFORMATION

Part Number: [1731092222](#)
Status: **Active**
Overview: [FCT D-Sub Connectors](#)
Description: FCT Standard-Density D-Sub Connector, Female, Right-Angle, Surface Mount, 3.70mm Contact Height, 500 Mating Cycles, Diecast Bracket, 25 Circuits

Documents:

[RoHS Certificate of Compliance \(PDF\)](#)

General

Product Family	D-Sub Products
Series	173109
Brochure Order No	987651-9941
Exclude SD Check	Yes
IP Rating	IP20
Overview	FCT D-Sub Connectors
Product Category	D-Sub Connector
Product Name	FCT Products
Type	Standard Density
UPC	191130550944

Physical

Circuits (Loaded)	25
Circuits (maximum)	25
Color - Resin	Natural
Durability (mating cycles max)	500
Gender	Female
Material - Contact	Copper Alloy
Material - Resin	PBT
Material - Shell	Steel
Net Weight	17.700/g
Number of Rows	2
Orientation	Right-Angle
PC Tail Length	3.70mm
PCB Locator	Yes
PCB Retention	Yes
PCB Thickness - Recommended	1.60mm
Packaging Type	Embossed Tape on Reel
Panel Mount	Rear
Panel Mount Method	Thread-In
Pitch - Mating Interface	2.84mm
Pitch - Termination Interface	3.40mm
Plating - Contact	Gold over Palladium Nickel
Plating - Shell	Nickel
Polarized to Mating Part	Yes
Polarized to PCB	Yes
Ports	1
Shielded	Yes
Surface Mount Compatible (SMC)	Yes
Temperature Range - Operating	-55° to +150°C
Termination Style	Surface Mount
Waterproof / Dustproof	No
Waterproof / Dustproof Type	IP20

Electrical

Current - Maximum per Contact	5.0A
-------------------------------	------

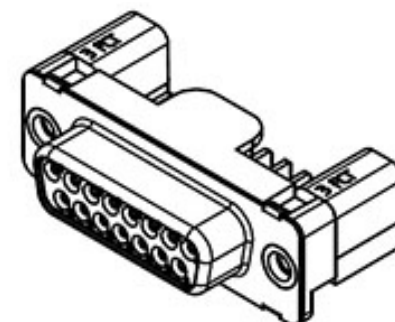

Series image - Reference only

EU ELV

Not Reviewed

EU RoHS

Not Reviewed

REACH SVHC

Not Reviewed

Halogen-Free

Status

Not Reviewed

For more information, please visit [Contact US](#)

China ROHS

Not Reviewed

ELV

Not Reviewed

RoHS Phthalates

Not Reviewed

Search Parts in this Series

[173109 Series](#)

Mates With

FCT Standard-Density D-Sub, Size 3, 25 Position, Plug

Material Info
Engineering Number

FSLT25S101G1-3752

This document was generated on 07/24/2019

PLEASE CHECK WWW.MOLEX.COM FOR LATEST PART INFORMATION