

Schottky Barrier Rectifiers

■ **Product Character**

- Multilayer Metal -Silicon Potential Structure.
- Low Leakage Current.
- High Current Capability, High Efficiency.
- High Junction Temperature Capability.
- RoHs Product.

■ **Primary Use**

- Low Voltage High Frequency Switching Power Supply.
- Low Voltage High Frequency Invers Circuit.
- Low Voltage Continued Circuit and Protection Circuit.

■ **Summarize**

- S B 1 5 4 5 Device optimized for ultra-low forward voltage drop to maximize efficiency in Power Supply applications.

■ **Equivalent Circuit**

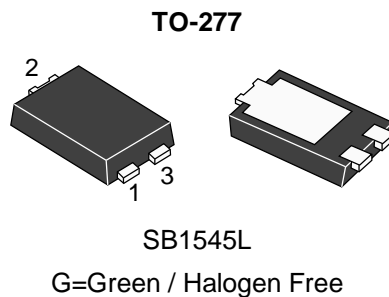
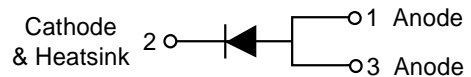

Absolute Maximum Ratings

Item	Symbol	Data	Unit
Maximal Inverted Repetitive Peak Voltage	V_{RRM}	45	V
*Average Rectified Forward Current (Rated VR-20Khz Square Wave) - 50% duty cycle	I_{FAV}	15	A
Forward Peak Surge Current(Rated Load 8.3 Half Mssine Wave-According to JEDEC Method)	I_{FSM}	150	A
Operating Junction Temperature	T_J	150	°C
Storage Temperature	T_{STG}	-40~150	°C
Typical Thermal Resistance(per leg)	Package=TO-277 $R_{\theta JC}$	8	°C/W

Electricity Character

Item	Test Condition		Value(min)	Value(typ)	Value(max)	Unit
V_B	$T_J = 25^{\circ}C$	$I_R = 100\mu A$	200	---	---	V
I_R	$T_J = 25^{\circ}C$	$V_R = 45V$	---	---	0.01	mA
	$T_J = 125^{\circ}C$	$V_R = 45V$	---	---	0.50	mA
V_F	$T_J = 25^{\circ}C$	$I_F = 15A$ ($I_{FAV} = 15A \times 1$)	---	0.54	0.60	V
	$T_J = 125^{\circ}C$		---	---	0.47	V

Schottky Barrier Rectifiers

Characteristic Curves

The forward voltage and forward current curve

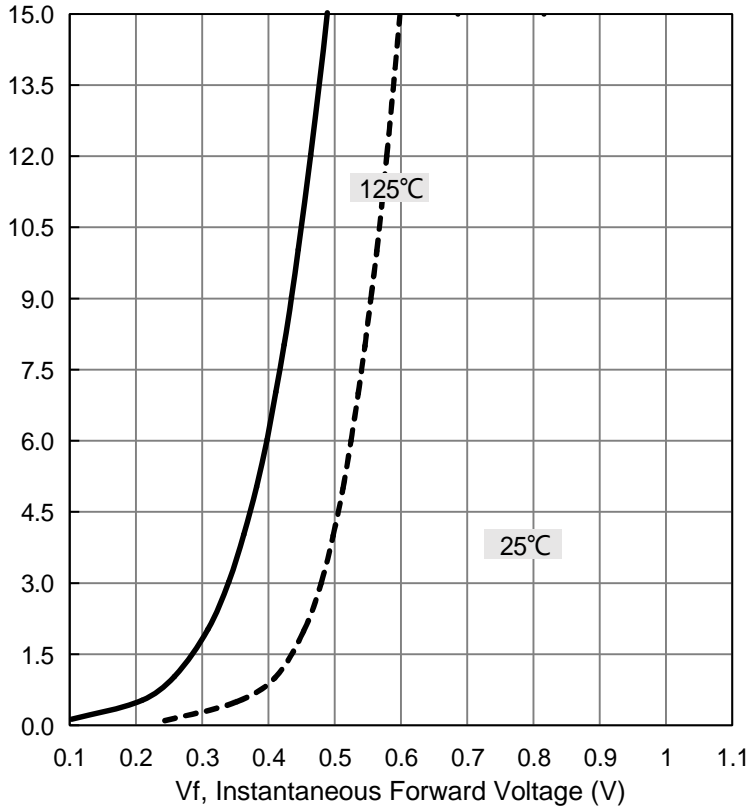

Current derating curve, per element

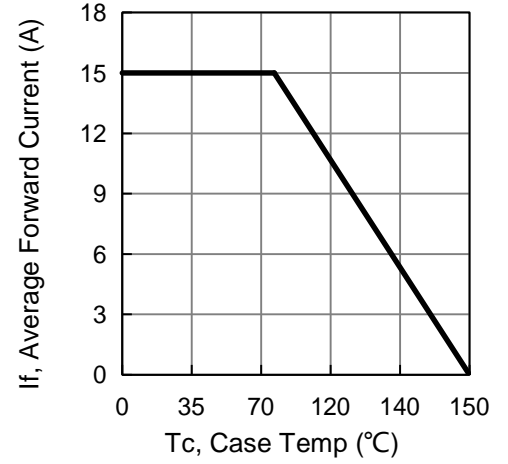

The reverse leak current and the reverse voltage (single-device) curve.

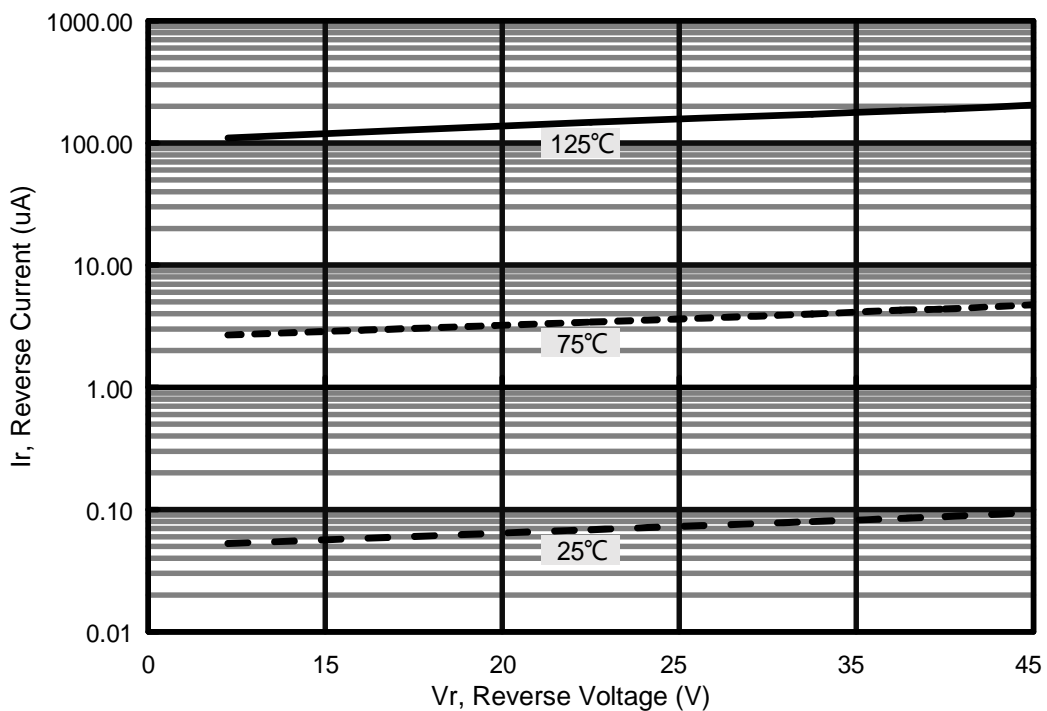

Schottky Barrier Rectifiers

Package Outline Dimensions & Suggested Solder Pad Layout

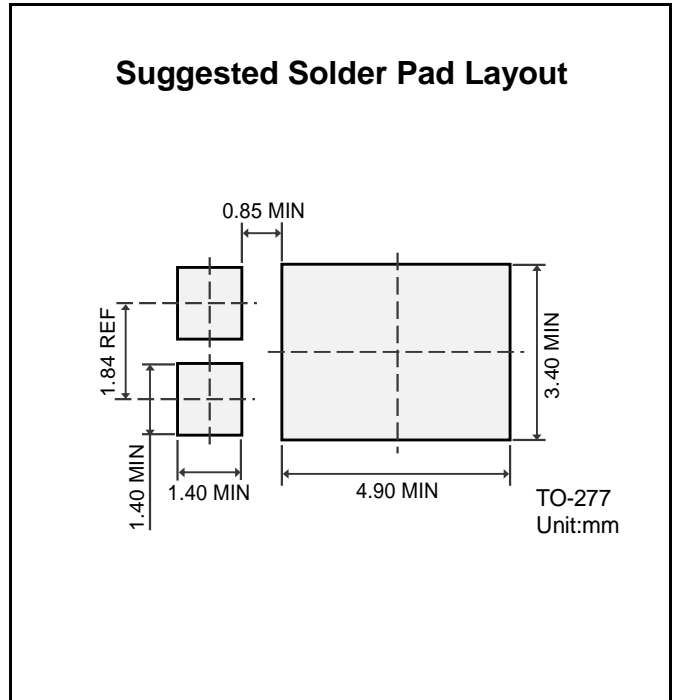
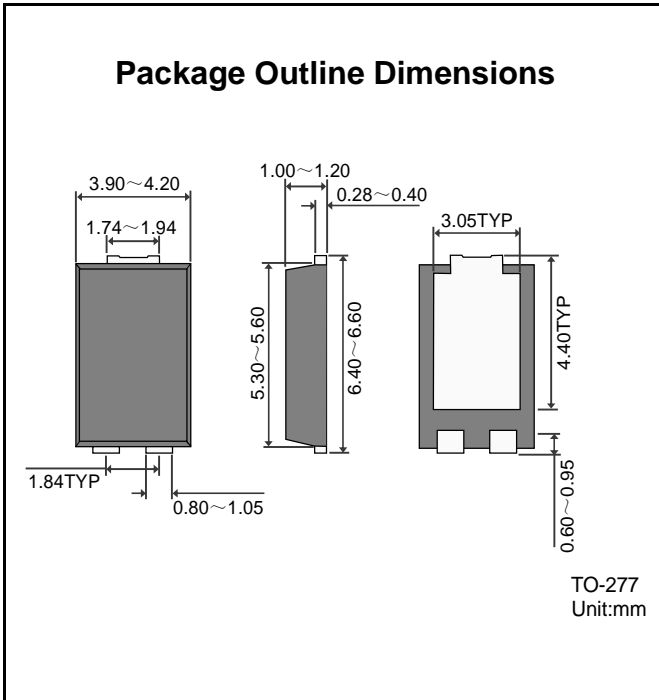

Packing Information

Packaging	Package	Reel Quantity	Reel Size	Tape Size
Reel	TO-277	5000 pcs	13'	12 mm

