

LM78Mxx Precision 500mA regulators

Features

- Output current to 0.5 A
- Output voltages of 5; 6; 8; 9; 10; 12; 15; 24 V
- Thermal overload protection
- Short circuit protection
- Output transition SOA protection
- $\pm 2\%$ output voltage tolerance
- Guaranteed in extended temperature range

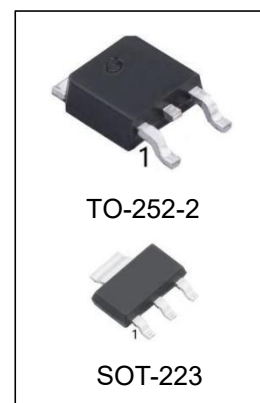

Ordering Information

DEVICE	Package Type	MARKING	Packing	Packing Qty
LM78M05CDT/TR	TO-252-2	LM78M05,78M05	REEL	2500pcs/reel
LM78M06CDT/TR	TO-252-2	LM78M06,78M06	REEL	2500pcs/reel
LM78M08CDT/TR	TO-252-2	LM78M08,78M08	REEL	2500pcs/reel
LM78M09CDT/TR	TO-252-2	LM78M09,78M09	REEL	2500pcs/reel
LM78M10CDT/TR	TO-252-2	LM78M10,78M10	REEL	2500pcs/reel
LM78M12CDT/TR	TO-252-2	LM78M12,78M12	REEL	2500pcs/reel
LM78M15CDT/TR	TO-252-2	LM78M15,78M15	REEL	2500pcs/reel
LM78M24CDT/TR	TO-252-2	LM78M24,78M24	REEL	2500pcs/reel
LM78M05MP/TR	SOT-223	78M05	REEL	2500pcs/reel
LM78M06MP/TR	SOT-223	78M06	REEL	2500pcs/reel
LM78M08MP/TR	SOT-223	78M08	REEL	2500pcs/reel
LM78M09MP/TR	SOT-223	78M09	REEL	2500pcs/reel
LM78M10MP/TR	SOT-223	78M10	REEL	2500pcs/reel
LM78M12MP/TR	SOT-223	78M12	REEL	2500pcs/reel
LM78M15MP/TR	SOT-223	78M15	REEL	2500pcs/reel
LM78M24MP/TR	SOT-223	78M24	REEL	2500pcs/reel

Description

The LM78Mxx series of three-terminal positive regulators is available in DPAK .packages and with several fixed output voltages, making it useful in a wide range of applications. These regulators can provide local on-card regulation eliminating the distribution problems associated with single point regulation. Each type employs internal current limiting, thermal shutdown and safe area protection, making it essentially indestructible. If adequate heat sinking is provided, they can deliver over 0.5 A output current. Although designed primarily as fixed voltage regulators, these devices can be used with external components to obtain adjustable voltage and currents.

Pin Configuration

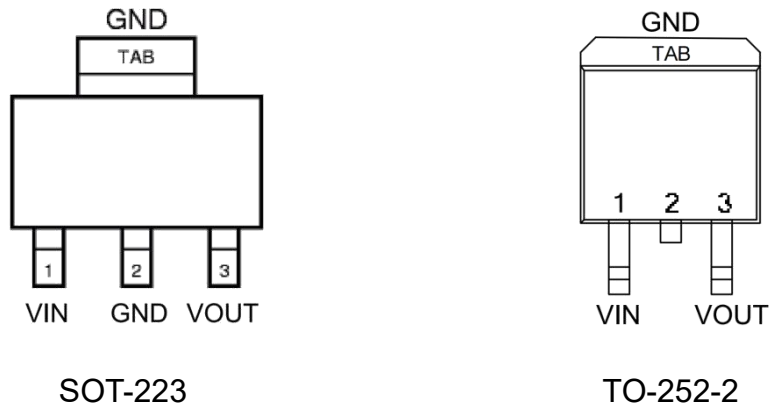
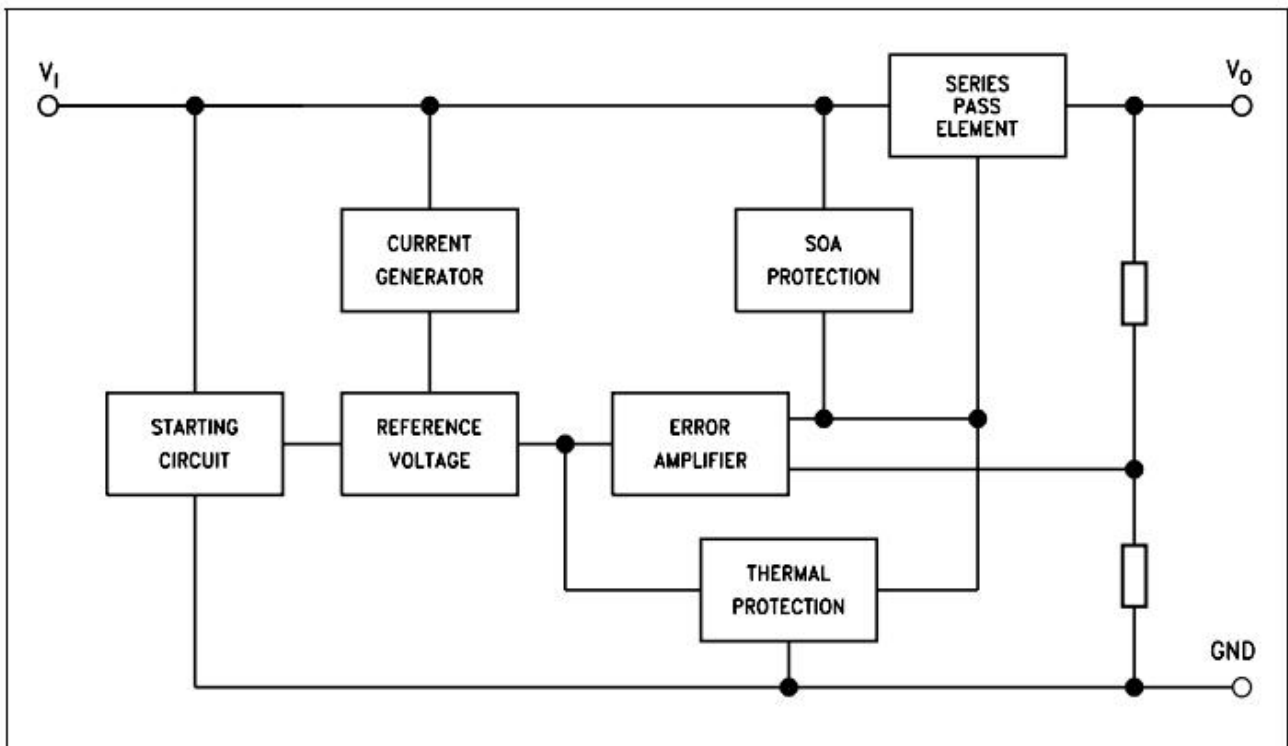

Figure 1. Block diagram



Maximum ratings

Table 2. Absolute maximum ratings

Symbol	Parameter	Value	Unit
V_i	DC input voltage	for $V_o = 5$ to 18 V	35
		for $V_o = 20, 24$ V	40
I_o	Output current	Internally limited	mA
P_D	Power dissipation	Internally limited	mW
T_{STG}	Storage temperature range	-65 to 150	°C
T_{OP}	Operating junction temperature range	0 to 125	°C
T_L	Lead Temperature (Soldering, 10 seconds)	260	°C

Note: Absolute maximum ratings are those values beyond which damage to the device may occur.

Functional operation under these condition is not implied.

Table 3. Thermal data

Symbol	Parameter	DPAK	Unit
R_{thJC}	Thermal resistance junction-case	8	°C/W
R_{thJA}	Thermal resistance junction-ambient	100	°C/W

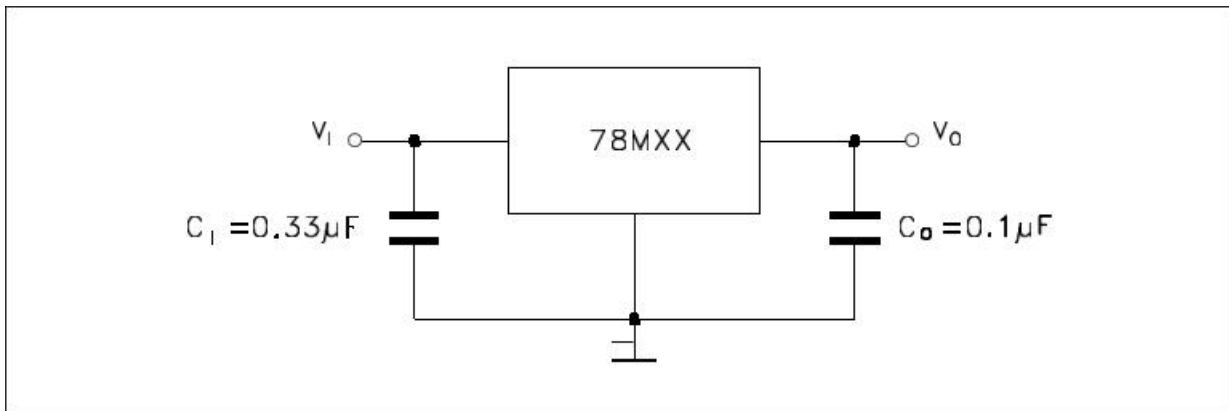
Figure 4. Application circuit

Electrical characteristics

Table 4. Electrical characteristics of LM78M05

 Refer to the test circuits, $V_I = 10\text{ V}$, $I_O = 350\text{ mA}$, $C_I = 0.33\mu\text{F}$, $C_O = 0.1\mu\text{F}$, $T_J = 0\text{ to }125^\circ\text{C}$ unless otherwise specified.

Symbol	Parameter	Test conditions	Min.	Typ.	Max.	Unit
V_O	Output voltage	$T_J = 25^\circ\text{C}$	4.9	5	5.1	V
V_O	Output voltage	$I_O = 5\text{ to }350\text{ mA}$, $V_I = 7\text{ to }20\text{ V}$	4.8	5	5.2	V
ΔV_O	Line regulation	$V_I = 7\text{ to }25\text{ V}$, $I_O = 200\text{ mA}$, $T_J = 25^\circ\text{C}$			100	mV
		$V_I = 8\text{ to }25\text{ V}$, $I_O = 200\text{ mA}$, $T_J = 25^\circ\text{C}$			50	
V_O	Load regulation	$I_O = 5\text{ to }500\text{ mA}$, $T_J = 25^\circ\text{C}$			100	mV
		$I_O = 5\text{ to }200\text{ mA}$, $T_J = 25^\circ\text{C}$			50	
I_d	Quiescent current	$T_J = 25^\circ\text{C}$			6	mA
ΔI_d	Quiescent current change	$I_O = 5\text{ to }350\text{ mA}$			0.5	mA
		$I_O = 200\text{ mA}$, $V_I = 8\text{ to }25\text{ V}$			0.8	
$\Delta V_O/\Delta T$	Output voltage drift	$I_O = 5\text{ mA}$		-0.5		mV/ $^\circ\text{C}$
SVR	Supply voltage rejection	$V_I = 8\text{ to }18\text{ V}$, $f = 120\text{ Hz}$, $I_O = 300\text{ mA}$, $T_J = 25^\circ\text{C}$	62			dB
eN	Output noise voltage	$B = 10\text{ Hz to }100\text{ kHz}$, $T_J = 25^\circ\text{C}$		40		μV
V_d	Dropout voltage	$T_J = 25^\circ\text{C}$		2		V
I_{sc}	Short circuit current	$T_J = 25^\circ\text{C}$, $V_I = 35\text{ V}$		300		mA
I_{scp}	Short circuit peak current	$T_J = 25^\circ\text{C}$		700		mA

Table 5. Electrical characteristics of LM78M06

 Refer to the test circuits, $V_I = 11\text{ V}$, $I_O = 350\text{ mA}$, $C_I = 0.33\mu\text{F}$, $C_O = 0.1\mu\text{F}$, $T_J = 0\text{ to }125^\circ\text{C}$ unless otherwise specified.

Symbol	Parameter	Test conditions	Min.	Typ.	Max.	Unit
V_O	Output voltage	$T_J = 25^\circ\text{C}$	5.88	6	6.12	V
V_O	Output voltage	$I_O = 5\text{ to }350\text{ mA}$, $V_I = 8\text{ to }21\text{ V}$	5.75	6	6.3	V
ΔV_O	Line regulation	$V_I = 8\text{ to }25\text{ V}$, $I_O = 200\text{ mA}$, $T_J = 25^\circ\text{C}$			100	mV
		$V_I = 9\text{ to }25\text{ V}$, $I_O = 200\text{ mA}$, $T_J = 25^\circ\text{C}$			30	
ΔV_O	Load regulation	$I_O = 5\text{ to }500\text{ mA}$, $T_J = 25^\circ\text{C}$			120	mV
		$I_O = 5\text{ to }200\text{ mA}$, $T_J = 25^\circ\text{C}$			60	
I_d	Quiescent current	$T_J = 25^\circ\text{C}$			6	mA
ΔI_d	Quiescent current change	$I_O = 5\text{ to }350\text{ mA}$			0.5	mA
		$I_O = 200\text{ mA}$, $V_I = 9\text{ to }25\text{ V}$			0.8	
$\Delta V_O/\Delta T$	Output voltage drift	$I_O = 5\text{ mA}$		-0.5		mV/ $^\circ\text{C}$
SVR	Supply voltage rejection	$V_I = 9\text{ to }19\text{ V}$, $f = 120\text{ Hz}$, $I_O = 300\text{ mA}$, $T_J = 25^\circ\text{C}$	59			dB
eN	Output noise voltage	$B = 10\text{ Hz to }100\text{ kHz}$		45		μV
V_d	Dropout voltage	$T_J = 25^\circ\text{C}$		2		V
I_{sc}	Short circuit current	$T_J = 25^\circ\text{C}$, $V_I = 35\text{ V}$		270		mA
I_{scp}	Short circuit peak current	$T_J = 25^\circ\text{C}$		700		mA

Table 6. Electrical characteristics of LM78M08

 Refer to the test circuits, $V_I = 14\text{ V}$, $I_O = 350\text{ mA}$, $C_I = 0.33\mu\text{F}$, $C_O = 0.1\mu\text{F}$, $T_J = 0$ to 125°C unless otherwise specified.

Symbol	Parameter	Test conditions	Min.	Typ.	Max.	Unit
V_O	Output voltage	$T_J = 25^\circ\text{C}$	7.84	8	8.16	V
V_O	Output voltage	$I_O = 5$ to 350 mA , $V_I = 10.5$ to 23 V	7.7	8	8.3	V
ΔV_O	Line regulation	$V_I = 10.5$ to 25 V , $I_O = 200\text{ mA}$, $T_J = 25^\circ\text{C}$			100	mV
		$V_I = 11$ to 25 V , $I_O = 200\text{ mA}$, $T_J = 25^\circ\text{C}$			30	
ΔV_O	Load regulation	$I_O = 5$ to 500 mA , $T_J = 25^\circ\text{C}$			160	mV
		$I_O = 5$ to 200 mA , $T_J = 25^\circ\text{C}$			80	
I_d	Quiescent current	$T_J = 25^\circ\text{C}$			6	mA
ΔI_d	Quiescent current change	$I_O = 5$ to 350 mA			0.5	mA
		$I_O = 200\text{ mA}$, $V_I = 10.5$ to 25 V			0.8	
$\Delta V_O/\Delta T$	Output voltage drift	$I_O = 5\text{ mA}$		-0.5		mV/ $^\circ\text{C}$
SVR	Supply voltage rejection	$V_I = 11.5$ to 21.5 V , $f = 120\text{ Hz}$ $I_O = 300\text{ mA}$, $T_J = 25^\circ\text{C}$	56			dB
eN	Output noise voltage	$B = 10\text{ Hz}$ to 100 kHz , $T_J = 25^\circ\text{C}$		52		μV
V_d	Dropout voltage	$T_J = 25^\circ\text{C}$		2		V
I_{sc}	Short circuit current	$T_J = 25^\circ\text{C}$, $V_I = 35\text{ V}$		250		mA
I_{scp}	Short circuit peak current	$T_J = 25^\circ\text{C}$		700		mA

Table 7. Electrical characteristics of LM78M09

 Refer to the test circuits, $V_I = 15\text{ V}$, $I_O = 350\text{ mA}$, $C_I = 0.33\mu\text{F}$, $C_O = 0.1\mu\text{F}$, $T_J = 0$ to 125°C unless otherwise specified.

Symbol	Parameter	Test conditions	Min.	Typ.	Max.	Unit
V_O	Output voltage	$T_J = 25^\circ\text{C}$	8.82	9	9.18	V
V_O	Output voltage	$I_O = 5$ to 350 mA , $V_I = 11.5$ to 24 V	8.64	9	9.36	V
ΔV_O	Line regulation	$V_I = 11.5$ to 25 V , $I_O = 200\text{ mA}$, $T_J = 25^\circ\text{C}$			100	mV
		$V_I = 12$ to 25 V , $I_O = 200\text{ mA}$, $T_J = 25^\circ\text{C}$			30	
ΔV_O	Load regulation	$I_O = 5$ to 500 mA , $T_J = 25^\circ\text{C}$			180	mV
		$I_O = 5$ to 200 mA , $T_J = 25^\circ\text{C}$			90	
I_d	Quiescent current	$T_J = 25^\circ\text{C}$			6	mA
ΔI_d	Quiescent current change	$I_O = 5$ to 350 mA			0.5	mA
		$I_O = 200\text{ mA}$, $V_I = 11.5$ to 25 V			0.8	
$\Delta V_O/\Delta T$	Output voltage drift	$I_O = 5\text{ mA}$		-0.5		mV/ $^\circ\text{C}$
SVR	Supply voltage rejection	$V_I = 12.5$ to 23 V , $f = 120\text{ Hz}$, $I_O = 300\text{ mA}$, $T_J = 25^\circ\text{C}$	56			dB
eN	Output noise voltage	$B = 10\text{ Hz}$ to 100 kHz , $T_J = 25^\circ\text{C}$		52		μV
V_d	Dropout voltage	$T_J = 25^\circ\text{C}$		2		V
I_{sc}	Short circuit current	$V_I = 35\text{ V}$, $T_J = 25^\circ\text{C}$		250		mA
I_{scp}	Short circuit peak current	$T_J = 25^\circ\text{C}$		700		mA

Table 8. Electrical characteristics of LM78M010

 Refer to the test circuits, $V_I = 16\text{ V}$, $I_O = 350\text{ mA}$, $C_I = 0.33\mu\text{F}$, $C_O = 0.1\mu\text{F}$, $T_J = 0\text{ to }125^\circ\text{C}$ unless otherwise specified.

Symbol	Parameter	Test conditions	Min.	Typ.	Max.	Unit
V_O	Output voltage	$T_J = 25^\circ\text{C}$	9.8	10	10.2	V
V_O	Output voltage	$I_O = 5\text{ to }350\text{ mA}$, $V_I = 12.5\text{ to }25\text{ V}$	9.6	10	10.4	V
ΔV_O	Line regulation	$V_I = 12.5\text{ to }30\text{ V}$, $I_O = 200\text{ mA}$, $T_J = 25^\circ\text{C}$			100	mV
		$V_I = 13\text{ to }30\text{ V}$, $I_O = 200\text{ mA}$, $T_J = 25^\circ\text{C}$			30	
ΔV_O	Load regulation	$I_O = 5\text{ to }500\text{ mA}$, $T_J = 25^\circ\text{C}$			200	mV
		$I_O = 5\text{ to }200\text{ mA}$, $T_J = 25^\circ\text{C}$			100	
I_d	Quiescent current	$T_J = 25^\circ\text{C}$			6	mA
ΔI_d	Quiescent current change	$I_O = 5\text{ to }350\text{ mA}$			0.5	mA
		$I_O = 200\text{ mA}$, $V_I = 12.5\text{ to }30\text{ V}$			0.8	
$\Delta V_O/\Delta T$	Output voltage drift	$I_O = 5\text{ mA}$		-0.5		mV/ $^\circ\text{C}$
SVR	Supply voltage rejection	$V_I = 13.5\text{ to }24\text{ V}$, $f = 120\text{ Hz}$, $I_O = 300\text{ mA}$, $T_J = 25^\circ\text{C}$	56			dB
eN	Output noise voltage	$B = 10\text{ Hz to }100\text{ kHz}$, $T_J = 25^\circ\text{C}$		64		μV
V_d	Dropout voltage	$T_J = 25^\circ\text{C}$		2		V
I_{sc}	Short circuit current	$V_I = 35\text{ V}$, $T_J = 25^\circ\text{C}$		245		mA
I_{scp}	Short circuit peak current	$T_J = 25^\circ\text{C}$		700		mA

Table 9. Electrical characteristics of LM78M012

 Refer to the test circuits, $V_I = 19\text{ V}$, $I_O = 350\text{ mA}$, $C_I = 0.33\mu\text{F}$, $C_O = 0.1\mu\text{F}$, $T_J = 0\text{ to }125^\circ\text{C}$ unless otherwise specified.

Symbol	Parameter	Test conditions	Min.	Typ.	Max.	Unit
V_O	Output voltage	$T_J = 25^\circ\text{C}$	11.75	12	12.25	V
V_O	Output voltage	$I_O = 5\text{ to }350\text{ mA}$, $V_I = 14.5\text{ to }27\text{ V}$	11.5	12	12.5	V
ΔV_O	Line regulation	$V_I = 14.5\text{ to }30\text{ V}$, $I_O = 200\text{ mA}$, $T_J = 25^\circ\text{C}$			100	mV
		$V_I = 16\text{ to }30\text{ V}$, $I_O = 200\text{ mA}$, $T_J = 25^\circ\text{C}$			30	
ΔV_O	Load regulation	$I_O = 5\text{ to }500\text{ mA}$, $T_J = 25^\circ\text{C}$			240	mV
		$I_O = 5\text{ to }200\text{ mA}$, $T_J = 25^\circ\text{C}$			120	
I_d	Quiescent current	$T_J = 25^\circ\text{C}$			6	mA
ΔI_d	Quiescent current change	$I_O = 5\text{ to }350\text{ mA}$			0.5	mA
		$I_O = 200\text{ mA}$, $V_I = 14.5\text{ to }30\text{ V}$			0.8	
$\Delta V_O/\Delta T$	Output voltage drift	$I_O = 5\text{ mA}$		-1		mV/ $^\circ\text{C}$
SVR	Supply voltage rejection	$V_I = 15\text{ to }25\text{ V}$, $f = 120\text{ Hz}$, $I_O = 300\text{ mA}$, $T_J = 25^\circ\text{C}$	55			dB
eN	Output noise voltage	$B = 10\text{ Hz to }100\text{ kHz}$, $T_J = 25^\circ\text{C}$		75		μV
V_d	Dropout voltage	$T_J = 25^\circ\text{C}$		2		V
I_{sc}	Short circuit current	$V_I = 35\text{ V}$, $T_J = 25^\circ\text{C}$		240		mA
I_{scp}	Short circuit peak current	$T_J = 25^\circ\text{C}$		700		mA

Table 10. Electrical characteristics of LM78M015

 Refer to the test circuits, $V_I = 23\text{ V}$, $I_O = 350\text{ mA}$, $C_I = 0.33\mu\text{F}$, $C_O = 0.1\mu\text{F}$, $T_J = 0\text{ to }125^\circ\text{C}$ unless otherwise specified.

Symbol	Parameter	Test conditions	Min.	Typ.	Max.	Unit
V_O	Output voltage	$T_J = 25^\circ\text{C}$	14.7	15	15.3	V
V_O	Output voltage	$I_O = 5\text{ to }350\text{ mA}$, $V_I = 17.5\text{ to }30\text{ V}$	14.4	15	15.6	V
ΔV_O	Line regulation	$V_I = 17.5\text{ to }30\text{ V}$, $I_O = 200\text{ mA}$, $T_J = 25^\circ\text{C}$			100	mV
		$V_I = 20\text{ to }30\text{ V}$, $I_O = 200\text{ mA}$, $T_J = 25^\circ\text{C}$			30	
ΔV_O	Load regulation	$I_O = 5\text{ to }500\text{ mA}$, $T_J = 25^\circ\text{C}$			300	mV
		$I_O = 5\text{ to }200\text{ mA}$, $T_J = 25^\circ\text{C}$			150	
I_d	Quiescent current	$T_J = 25^\circ\text{C}$			6	mA
ΔI_d	Quiescent current change	$I_O = 5\text{ to }350\text{ mA}$			0.5	mA
		$I_O = 200\text{ mA}$, $V_I = 17.5\text{ to }30\text{ V}$			0.8	
$\Delta V_O/\Delta T$	Output voltage drift	$I_O = 5\text{ mA}$		-1		mV/ $^\circ\text{C}$
SVR	Supply voltage rejection	$V_I = 18.5\text{ to }28.5\text{ V}$, $f = 120\text{ Hz}$, $I_O = 300\text{ mA}$, $T_J = 25^\circ\text{C}$	54			dB
eN	Output noise voltage	$B = 10\text{ Hz to }100\text{ kHz}$, $T_J = 25^\circ\text{C}$		90		μV
V_d	Dropout voltage	$T_J = 25^\circ\text{C}$		2		V
I_{sc}	Short circuit current	$V_I = 35\text{ V}$, $T_J = 25^\circ\text{C}$		240		mA
I_{scp}	Short circuit peak current	$T_J = 25^\circ\text{C}$		700		mA

Table 11. Electrical characteristics of LM78M024

 Refer to the test circuits, $V_I = 33\text{ V}$, $I_O = 350\text{ mA}$, $C_I = 0.33\mu\text{F}$, $C_O = 0.1\mu\text{F}$, $T_J = 0\text{ to }125^\circ\text{C}$ unless otherwise specified.

Symbol	Parameter	Test conditions	Min.	Typ.	Max.	Unit
V_O	Output voltage	$T_J = 25^\circ\text{C}$	23.5	24	24.5	V
V_O	Output voltage	$I_O = 5\text{ to }350\text{ mA}$, $V_I = 27\text{ to }38\text{ V}$	23	24	25	V
ΔV_O	Line regulation	$V_I = 27\text{ to }38\text{ V}$, $I_O = 200\text{ mA}$, $T_J = 25^\circ\text{C}$			100	mV
		$V_I = 28\text{ to }38\text{ V}$, $I_O = 200\text{ mA}$, $T_J = 25^\circ\text{C}$			30	
ΔV_O	Load regulation	$I_O = 5\text{ to }500\text{ mA}$, $T_J = 25^\circ\text{C}$			480	mV
		$I_O = 5\text{ to }200\text{ mA}$, $T_J = 25^\circ\text{C}$			240	
I_d	Quiescent current	$T_J = 25^\circ\text{C}$			6	mA
ΔI_d	Quiescent current change	$I_O = 5\text{ to }350\text{ mA}$			0.5	mA
		$I_O = 200\text{ mA}$, $V_I = 27\text{ to }38\text{ V}$			0.8	
$\Delta V_O/\Delta T$	Output voltage drift	$I_O = 5\text{ mA}$		-1.2		mV/ $^\circ\text{C}$
SVR	Supply voltage rejection	$V_I = 28\text{ to }38\text{ V}$, $f = 120\text{ Hz}$, $I_O = 300\text{ mA}$, $T_J = 25^\circ\text{C}$	50			dB
eN	Output noise voltage	$B = 10\text{ Hz to }100\text{ kHz}$, $T_J = 25^\circ\text{C}$		170		μV
V_d	Dropout voltage	$T_J = 25^\circ\text{C}$		2		V
I_{sc}	Short circuit current	$V_I = 35\text{ V}$, $T_J = 25^\circ\text{C}$		240		mA
I_{scp}	Short circuit peak current	$T_J = 25^\circ\text{C}$		700		mA

Typical performance

Figure 8. Dropout voltage vs. junction temp.

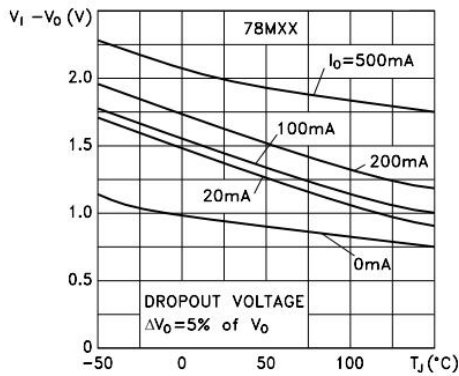

Figure 9. Dropout characteristics

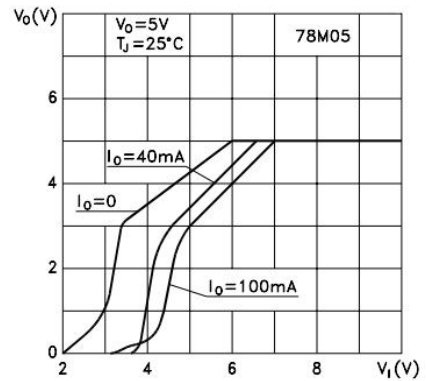

Figure 10. Peak output current vs. input/output differential voltage

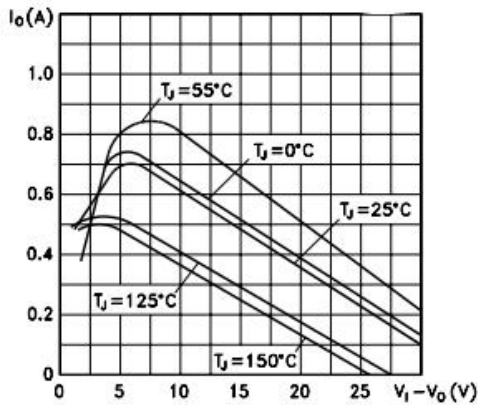

Figure 11. Output voltage vs. junction temperature

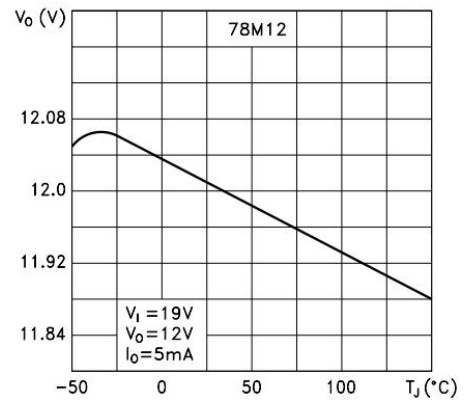

Figure 12. Supply voltage rejection vs. frequency

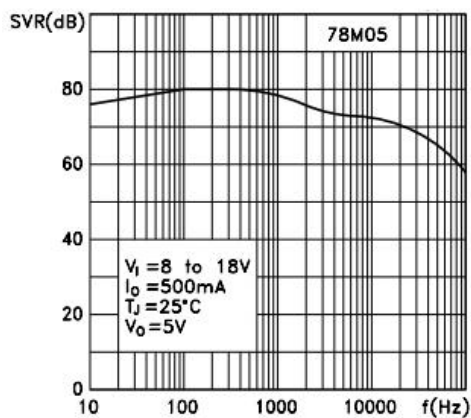
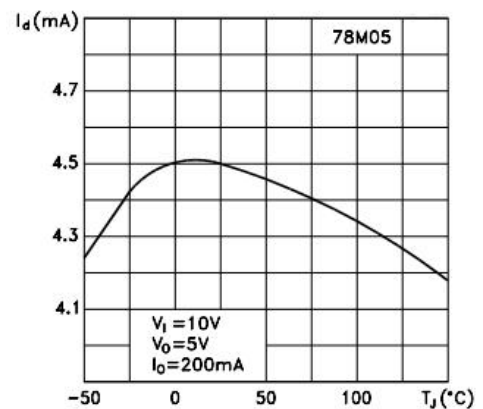

Figure 13. Quiescent current vs. junction temperature



Typical performance

Figure 14. Load transient response

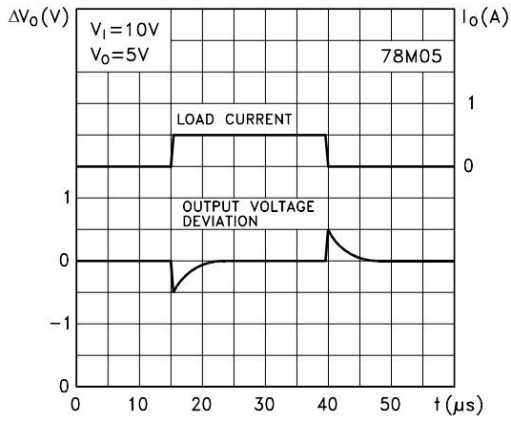

Figure 15. Line transient response

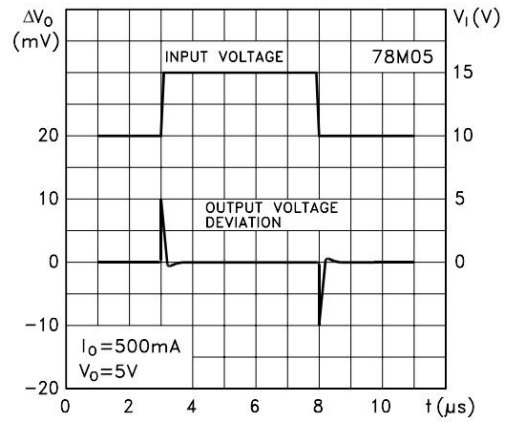
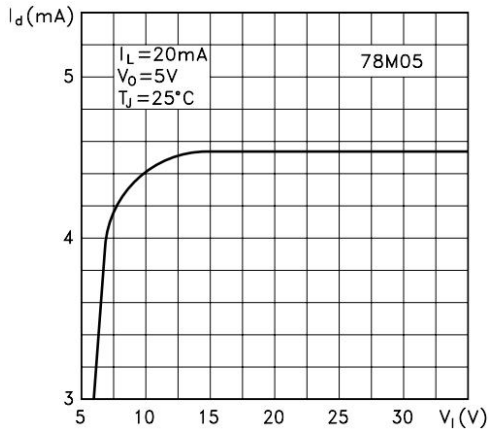
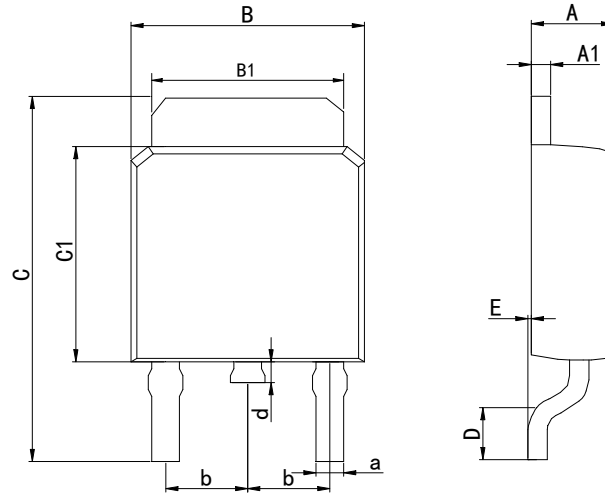

Figure 16. Quiescent current vs. input voltage



Physical Dimensions

TO-252-2 (A)



Dimensions In Millimeters(TO-252-2)

Symbol:	A	A1	B	B1	C	C1	D	E	a	d	b
Min:	2.10	0.45	6.40	5.10	9.20	5.30	0.90	0	0.50	0.60	2.28
Max:	2.50	0.70	6.80	5.50	10.6	6.30	1.75	0.23	0.80	1.20	BSC

TO-252-2 (B)

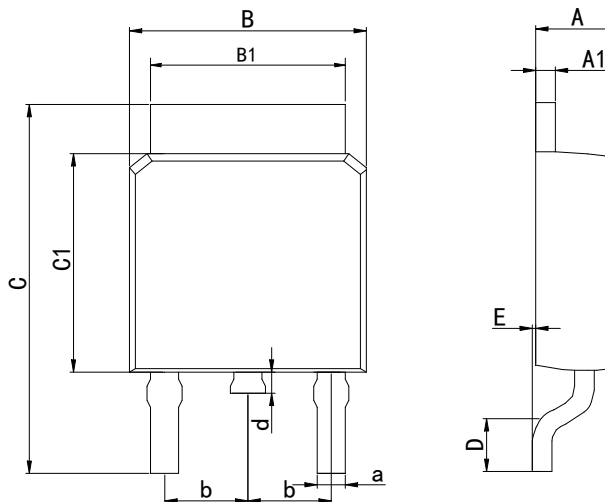

Dimensions In Millimeters(TO-252-2)

Symbol:	A	A1	B	B1	C	C1	D	E	a	d	b
Min:	2.10	0.45	6.40	5.10	9.20	5.30	0.90	0	0.50	0.60	2.28
Max:	2.50	0.70	6.80	5.50	10.6	6.30	1.75	0.23	0.80	1.20	BSC

SOT-223

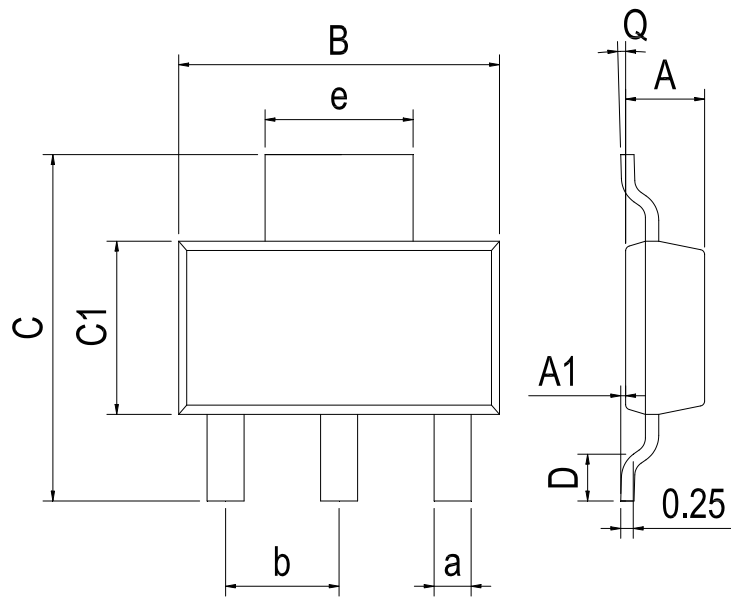

Dimensions In Millimeters(SOT-223)										
Symbol:	A	A1	B	C	C1	D	Q	a	b	e
Min:	1.50	0.05	6.30	6.70	3.30	0.65	0°	0.66	2.30 BSC	3.00 BSC
Max:	1.70	0.20	6.70	7.30	3.70	1.10	8°	0.84		

Revision History

REVISION NUMBER	DATE	REVISION	PAGE
V1.0	2014-6	New	1-12
V1.1	2019-7	Update encapsulation type	1、 3
V1.2	2024-11	Update Lead Temperature	3
V1.3	2025-6	Revise the ordering information table	1
V1.4	2025-12	Update important statements	13

IMPORTANT STATEMENT:

Huaguan Semiconductor reserves the right to change products and services offered without prior notice. Customers should obtain the latest relevant information before placing orders and verify that such information is current and complete. Huaguan Semiconductor assumes no responsibility or liability for altered documents.

Customers are responsible for complying with safety standards and implementing safety measures when using Huaguan Semiconductor products in system design and end-product manufacturing. You assume full responsibility for: selecting the appropriate Huaguan Semiconductor products for your application; designing, validating, and testing your application; and ensuring that your application complies with applicable standards and all other safety, security, or other requirements. This is to prevent potential risks that may lead to personal injury or property damage.

Huaguan Semiconductor products are not approved for use in life support, military, aerospace, or other high-risk applications. Huaguan products are neither intended nor warranted for use in such systems or equipment. Any failure or malfunction may lead to personal injury or severe property damage. Such applications are deemed "Unsafe Use." Unsafe Use includes, but is not limited to: surgical and medical equipment, nuclear energy control equipment, aircraft or spacecraft instruments, control or operation of vehicle power, braking, or safety systems, traffic signal instruments, all types of safety devices, and any other applications intended to support or sustain life. Huaguan Semiconductor shall not be liable for consequences resulting from Unsafe Use in these fields. Users must independently evaluate and assume all risks. Any issues, liabilities, or losses arising from the use of products beyond their approved applications shall be solely borne by the user. Users may not claim any compensation from Huaguan Semiconductor based on these terms. If any third party claims against Huaguan Semiconductor due to such Unsafe Use, the user shall compensate Huaguan Semiconductor for all resulting damages and liabilities.

Huaguan Semiconductor provides technical and reliability data (including datasheets), design resources (including reference designs), application or other design advice, web tools, safety information, and other resources for its semiconductor products. However, no guarantee is made that these resources are free from defects, and no express or implied warranties are provided. The use of testing and other quality control techniques is limited to Huaguan Semiconductor's quality assurance scope. Not all parameters of each device are tested.

Huaguan Semiconductor's documentation authorizes you to use these resources only for developing applications related to the products described herein. You are not granted rights to any other intellectual property of Huaguan Semiconductor or any third party. Any other reproduction or display of these resources is strictly prohibited. You shall fully indemnify Huaguan Semiconductor and its agents against any claims, damages, costs, losses, and liabilities arising from your use of these resources. Huaguan Semiconductor shall not be held responsible.