

SUMMARY



Image is for illustrative purpose only

Wires

Coax 1

Series 1S
Termination type Male solder Coaxial
IP rating 50
AWG wire size 0.00 - 0.00
Cable Ø 5.90 - 6.50 mm
Status active

Download

[Request a quote](#)
[Catalog](#)

TECHNICAL DETAILS

Mechanics

Shell Style/Model FLC*: Elbow (90°) plug with cable collet
Keying Circular, male
Housing Material Brass (chrome plated [SAE AMS 2460]) shell and collet nut, nickel plated [SAE AMS QQ N 290] brass latch sleeve and mid pieces
Weight 14.01 g

Performance

Configuration 1S.275 : 1 Coax (75 Ohm)
Insulator T: PTFE
Rated Current 10 Amps

Specifications

Contact Type: Coaxial 75 Ohm (Solder)
Contact Dia.: 1.3 mm (0.0512in)
Bucket Dia.: 1.1 mm (0.0432in)
Vtest: 2400 V (AC), 3300 V (DC)
Impedance: 75 Ohm
VSWR: 1.02 + 0.08 * f/GHz
Cable type: RG 179 B/U, RG 187 A/U, RG 58 C/U, RG 302 /U, RG 400 /U, 2YCCY, RG 59 B/U, RG 223 /U, HF-5408

LEMO products and services are provided "as is". LEMO makes no warranties or representations with regard to LEMO product & services or use of them, express, implied or statutory, including for accuracy, completeness, or security. The user is fully responsible for his products and applications using LEMO components.

Others

Endurance (Shell): 5000 mating cycles
Temp (min / max): -55°C / +250°C
Humidity (max): <=95% [at 60 deg C / 140 F]
Vibration: 15 g [10 Hz - 2000 Hz]
Shock Resistance: 100 g [6 ms]
Climatical Category: 50/175/21
Shielding (min): 75 dB (10 MHz)
Shielding (min): 40 dB (1 GHz)
Salt Spray Corrosion: >144 hr

DRAWINGS

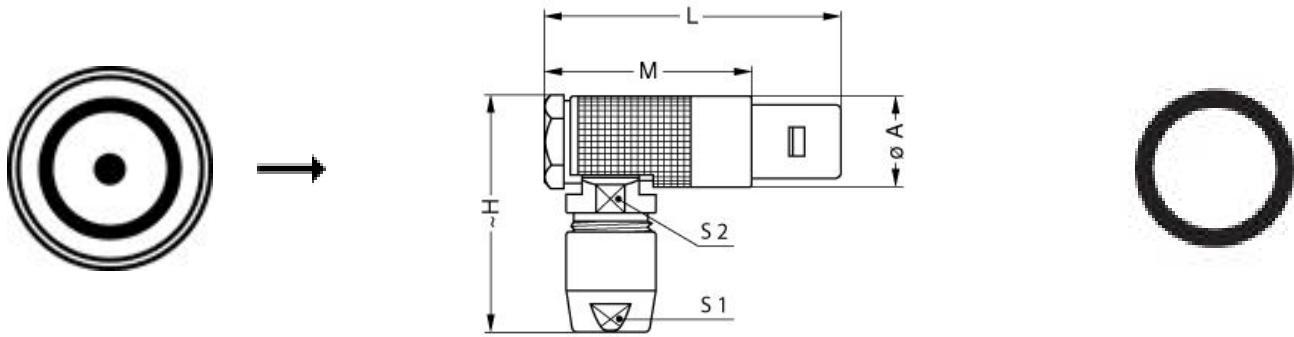

Dimensions

	A	H	L	M
mm.	12	27.5	29.6	18.6
in.	0,47	1,08	1,17	0,73

RECOMMENDED BY LEMO

Tools

LEMO products and services are provided "as is". LEMO makes no warranties or representations with regard to LEMO product & services or use of them, express, implied or statutory, including for accuracy, completeness, or security. The user is fully responsible for his products and applications using LEMO components.

Cables

159580	PVC	Black	
62000	PVC	Black	
CCX.50.RG0.58AU61J	PVC	Yellow	
CCX.75.RG0.59BU62N	PVC	Black	
CCX.93.RG0.62AU62N	PVC	Black	

LEMO products and services are provided "as is". LEMO makes no warranties or representations with regard to LEMO product & services or use of them, express, implied or statutory, including for accuracy, completeness, or security. The user is fully responsible for his products and applications using LEMO components.