

CC6920 High Performance, Hall Effect-Based Current Sensor IC with a Low-Resistance Conductor 2.5A/5A/10A/20A/25A/30A/40A/50A

FEATURES

- ◆ Zero current output voltage is 50%VCC
- ◆ Current sensing range available:
2.5A/5A/10A,20A/25A/30A/40A/50A
- ◆ High isolation and withstand voltage (3500V_{RMS} isolation voltage between pins 1-4 and 5-8)
- ◆ Less power loss, internal conductor's resistance is 0.9mΩ
- ◆ High bandwidth, up to 250kHz; Response time $t_{RES} = 1.2\mu s$
- ◆ Total output error $\pm 0.5\%$ at $T_A=25^\circ C$ and $\pm 3\%$ at $T_A=-40\sim 125^\circ C$
- ◆ Good temperature stability, using Hall signal amplification circuit and temperature compensation circuit
- ◆ Differential Hall structure, strong resistance to external magnetic interference
- ◆ Strong resistance to mechanical stress, magnetic parameters will not be offset by external pressure
- ◆ ESD (HBM) $\pm 6kV$, ESD (CDM) $\pm 1kV$, LU $\pm 200mA$

APPLICATIONS

- ◆ Motor controller
- ◆ Load detection and management
- ◆ Switch-mode power supplies
- ◆ Over-current fault protection
- ◆ Other applications requiring current detection



Certificate Number
LVD: AN 50544137 001
TUV MARK: R 50531528



Certificate Number
E526186-A6001-UL

GENERAL DESCRIPTION

The CC6920 device is a high-performance Hall-effect current sensor that can measure DC or AC current more efficiently, and has the advantages of high accuracy, excellent linearity and temperature stability in industrial, consumer, and communication equipment.

The CC6920 device consists of a high-precision, low-noise linear Hall integrated circuit and a low-resistance main current conductor. Internal copper conductor's resistance is typical 0.9mΩ, which provides much less power loss than the universal resistor sampling method. Otherwise, its internal inherent insulation provides 424V_{RMS} basic working isolation voltage and 3500V_{RMS} insulation withstand voltage between the input current path and the secondary circuit. The sensor adopts linear Hall sensor temperature compensation technology, which has high temperature stability characteristics. Zero current output voltage is 0.5V_{CC}.

When power supply voltage is 5V, the linear output voltage range is 0.2~4.8V, the linearity can reach 0.1%. The differential common-mode suppression circuit integrated in CC6920 can make the chip output unaffected by external interference magnetic signals. The integrated dynamic offset elimination circuit makes the sensitivity of the chip independent of external stress and chip packaging stress.

CC6920 is available in SOP8 package. It's operating ambient temperature range is -40~125°C. Comply with RoHS requirements.

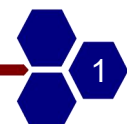

FUNCTION BLOCK DIAGRAM

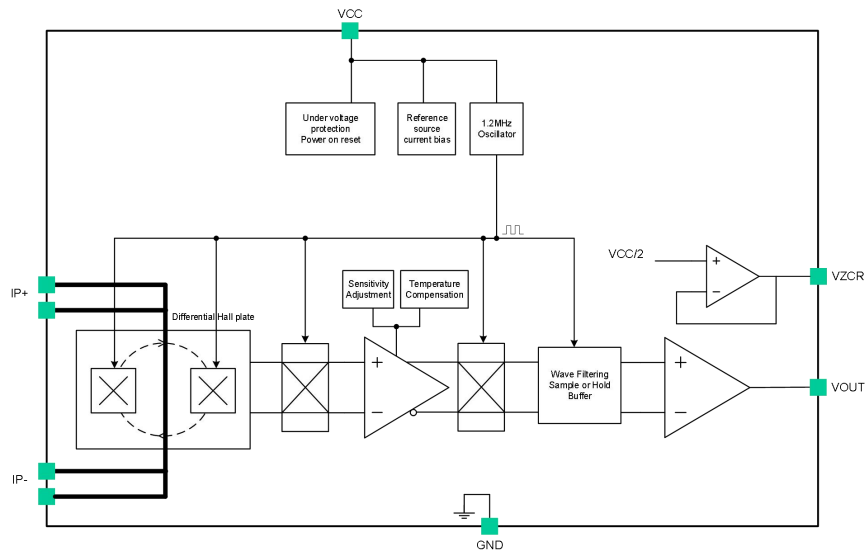

ORDERING INFORMATION

Part No.	SENS. (mV/A)	Package	Packing Form
CC6920SO-2.5A	800	SOP8	tape reel, 2000 pcs/reel
CC6920SO-5A	400	SOP8	tape reel, 2000 pcs/reel
CC6920SO-10A	200	SOP8	tape reel, 2000 pcs/reel
CC6920SO-20A	100	SOP8	tape reel, 2000 pcs/reel
CC6920SO-25A	80	SOP8	tape reel, 2000 pcs/reel
CC6920SO-30A	67	SOP8	tape reel, 2000 pcs/reel
CC6920SO-40A	50	SOP8	tape reel, 2000 pcs/reel
CC6920SO-50A	40	SOP8	tape reel, 2000 pcs/reel
CC6920SO-XXA (Note1)	-	SOP8	tape reel, 2000 pcs/reel

Note 1: When XXA is within the range of 50A, customers can customize the range according to their needs.

PINOUT DIAGRAM

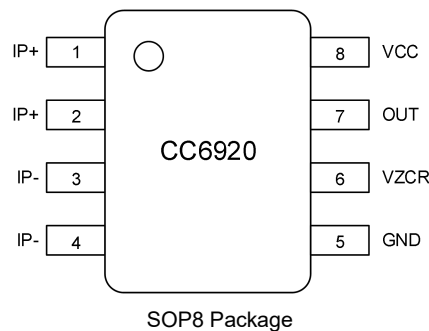

Name	Number	Description	Name	Number	Description
IP+	1	Current Sampled +	GND	5	Ground
IP+	2	Current Sampled +	VZCR	6	Zero Current Reference Signal Output
IP-	3	Current Sampled -	OUT	7	Analog Voltage Output
IP-	4	Current Sampled -	VCC	8	Power Supply

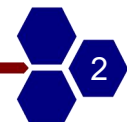

ABSOLUTE MAXIMUM RATINGS

Parameter	Symbol	Value	Unit
Power Supply	V _{CC}	7	V
Output Voltage	V _{OUT}	-0.3~V _{CC} +0.3	V
Output Source Current	I _{OUT (SOURCE)}	6	mA
Output Sink Current	I _{OUT (SINK)}	30	mA
Input current peak current (3 s)	I _{PEAK}	100	A
Input current continuous current	I _{CON}	40	A
Isolation Voltage	V _{ISO}	3500	VAC
Operating Ambient Temperature	T _A	-40~125	°C
Junction Temperature	T _J	165	°C
Storage Temperature	T _S	-55~150	°C
Magnetic Flux Density	B	Not Limited	mT
Electrostatic Discharge Voltage (ESD)	HBM	±6	kV
	CDM	±1	kV
Latch-up	LU	±200	mA

Note: Stresses beyond those listed under *Absolute Maximum Ratings* may cause permanent damage to the device. Exposure to absolute-maximum-rated conditions for extended periods may affect device reliability.

ISOLATION CHARACTERISTICS

Parameter	Symbol	Test Conditions	Value	Unit
Withstand isolation voltage	V _{ISO}	Test method: 50 / 60Hz, 1min	3500	V _{RMS}
	V _{TEST}	t = 1s (100% production)	3900	V _{RMS}
Working voltage of basic insulation	V _{WFSI}	Basic insulation	600	V _{PK}
		UL standard 62368-1:2014	424	V _{RMS}
Clearance	D _{cl}	minimum distance through air from IP leads to signal leads	3.8	mm
Maximum repetitive peak isolation voltage	V _{IORM}	AC voltage (bipolar)	600	V _{PK}
Maximum working isolation voltage	V _{IOWM}	AC voltage (sine wave)	424	V _{RMS}
		DC voltage	600	V _{DC}
Maximum transient isolation voltage	V _{IOTM}	Test method: t = 60s (qualification)	4949	V _{PK}
	V _{TEST}	t = 1s (100% production)	5515	
Maximum surge isolation voltage (Note 1)	V _{IOSM}	Tested 1.2us (rise) / 50us (width) One time	7000	V _{PK}
Surge Current (Note 2)	I _{SURGE}	Tested in compliance to IEC 61000-4-5 8μs (rise) / 20μs (width)	7.5	kA

Note1: Testing is carried out in air to determine the intrinsic surge immunity of the isolation barrier.

Note2: Certification pending.

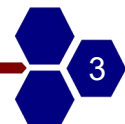

RECOMMENDED OPERATING CONDITIONS

Parameter	Symbol	Min.	Max.	Unit
Input voltage (Note 1)	VIN+, VIN- (Note 1)	-600	600	V _{PK}
Input current (DC / AC RMS) (Note 2)	I _P	-50	50	A
Power Supply	V _{CC}	4.5	5.5	V
Operation Temperature	T _A	-40	125	°C

Note 1: Vin +, VIN – refers to the voltage of current input pins IP + and IP -, relative to pin 5 (GND).

Note 2: Decrease due to higher ambient temperature.

ELECTRICAL PARAMETERS (T_A = 25°C and V_{CC} = 5V, unless otherwise specified)

Parameter	Symbol	Conditions	Min.	Typ.	Max.	Unit
Power Supply	V _{CC}	-	4.5	5	5.5	V
Supply Current	I _{CC}	OUT pin floated	-	20	25	mA
Zero Current Output Voltage	V _{OUT(Q)}	IP=0	2.490	2.500	2.510	V
Output Capacitance Load	C _L		-	-	1	nF
Output Resistive Load	R _L		1.5	-	-	kΩ
Res. of Primary Conductor	R _P	IP=2A	-	0.9	1.2	mΩ
Propagation Time	t _d			1	2	μs
Rise Time	t _r		-	1	2.2	μs
Common Mode Rejection Ratio	CMRR		38	-	-	dB
Bandwidth	BW	-3dB	250	-	-	kHz
Reference Output Source Current	I _{ZCR(SOURCE)}		-	-	400	μA
Reference Output Sink Current	I _{ZCR(SINK)}		-	-	3000	μA
Nonlinearity	Lin _{ERR}		-	0.1	0.5	%
Symmetry	Sym _{ERR}		-	0.5	1.5	%
Power-on Time	T _{POR}	Output rising from 0 to 90% of steady-state	-	10	-	μs

2.5A PERFORMANCE CHARACTERISTICS

Parameter	Symbol	Conditions	Min.	Typ.	Max.	Unit
Current Accuracy Range	I _P	-	-2.5	-	2.5	A
Sensitivity	Sens	full range of I _P	776	800	824	mV/A
Zero Current Differential Output Error	V _{OE}		-47		47	mV
Noise	V _{N(RMS)}		-	90	-	mV
Zero Current Output Slope	ΔV _{OUT(Q)}		-	0.34	-	mV/°C
Sensitivity Slope	Δ _{SENS}		-	0.192	-	mV/A/°C
Total Output Error	E _{TOT}		-3.0	-	3.0	%

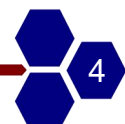

5A PERFORMANCE CHARACTERISTICS

Parameter	Symbol	Conditions	Min.	Typ.	Max.	Unit
Current Accuracy Range	I_P	-	-5	-	5	A
Sensitivity	Sens	full range of I_P	388	400	412	mV/A
Zero Current Differential Output Error	V_{OE}		-45		45	mV
Noise	$V_{N(RMS)}$		-	45	-	mV
Zero Current Output Slope	$\Delta V_{OUT(Q)}$		-	0.34	-	mV/°C
Sensitivity Slope	$\Delta SENS$		-	0.096	-	mV/A/°C
Total Output Error	E_{TOT}		-3.0	-	3.0	%

10A PERFORMANCE CHARACTERISTICS

Parameter	Symbol	Conditions	Min.	Typ.	Max.	Unit
Current Accuracy Range	I_P	-	-10	-	10	A
Sensitivity	Sens	full range of I_P	194	200	206	mV/A
Zero Current Differential Output Error	V_{OE}		-40		40	mV
Noise	$V_{N(RMS)}$		-	23	-	mV
Zero Current Output Slope	$\Delta V_{OUT(Q)}$		-	0.34	-	mV/°C
Sensitivity Slope	$\Delta SENS$		-	0.048	-	mV/A/°C
Total Output Error	E_{TOT}		-3.0	-	3.0	%

20A PERFORMANCE CHARACTERISTICS

Parameter	Symbol	Conditions	Min.	Typ.	Max.	Unit
Current Accuracy Range	I_P	-	-20	-	20	A
Sensitivity	Sens	full range of I_P	97	100	103	mV/A
Zero Current Differential Output Error	V_{OE}		-25		25	mV
Noise	$V_{N(RMS)}$		-	11	-	mV
Zero Current Output Slope	$\Delta V_{OUT(Q)}$		-	0.34	-	mV/°C
Sensitivity Slope	$\Delta SENS$		-	0.024	-	mV/A/°C
Total Output Error	E_{TOT}		-3.0	-	3.0	%

25A PERFORMANCE CHARACTERISTICS

Parameter	Symbol	Conditions	Min.	Typ.	Max.	Unit
Current Accuracy Range	I_P	-	-25	-	25	A
Sensitivity	Sens	full range of I_P	77.6	80	82.4	mV/A
Zero Current Differential Output Error	V_{OE}		-20		20	mV
Noise	$V_{N(RMS)}$		-	9	-	mV
Zero Current Output Slope	$\Delta V_{OUT(Q)}$		-	0.34	-	mV/°C
Sensitivity Slope	$\Delta SENS$		-	0.019	-	mV/A/°C
Total Output Error	E_{TOT}		-3.0	-	3.0	%

30A PERFORMANCE CHARACTERISTICS

Parameter	Symbol	Conditions	Min.	Typ.	Max.	Unit
Current Accuracy Range	I_P	-	-30	-	30	A
Sensitivity	Sens	full range of I_P	65	67	69	mV/A
Zero Current Differential Output Error	V_{OE}		-15		15	mV
Noise	$V_{N(RMS)}$		-	8	-	mV
Zero Current Output Slope	$\Delta V_{OUT(Q)}$		-	0.28	-	mV/°C
Sensitivity Slope	$\Delta SENS$		-	0.016	-	mV/A/°C
Total Output Error	E_{TOT}		-3.0	-	3.0	%

40A PERFORMANCE CHARACTERISTICS

Parameter	Symbol	Conditions	Min.	Typ.	Max.	Unit
Current Accuracy Range	I_P	-	-40	-	40	A
Sensitivity	Sens	full range of I_P	48.5	50	51.5	mV/A
Zero Current Differential Output Error	V_{OE}		-10		10	mV
Noise	$V_{N(RMS)}$		-	8	-	mV
Zero Current Output Slope	$\Delta V_{OUT(Q)}$		-	0.21	-	mV/°C
Sensitivity Slope	$\Delta SENS$		-	0.012	-	mV/A/°C
Total Output Error	E_{TOT}		-3.0	-	3.0	%

50A PERFORMANCE CHARACTERISTICS

Parameter	Symbol	Conditions	Min.	Typ.	Max.	Unit
Current Accuracy Range	I_P	-	-50	-	50	A
Sensitivity	Sens	full range of I_P	38.8	40	41.2	mV/A
Zero Current Differential Output Error	V_{OE}		-10		10	mV
Noise	$V_{N(RMS)}$		-	8	-	mV
Zero Current Output Slope	$\Delta V_{OUT(Q)}$		-	0.17	-	mV/°C
Sensitivity Slope	$\Delta SENS$		-	0.010	-	mV/A/°C
Total Output Error	E_{TOT}		-3.0	-	3.0	%

TYPICAL APPLICATION CIRCUITS

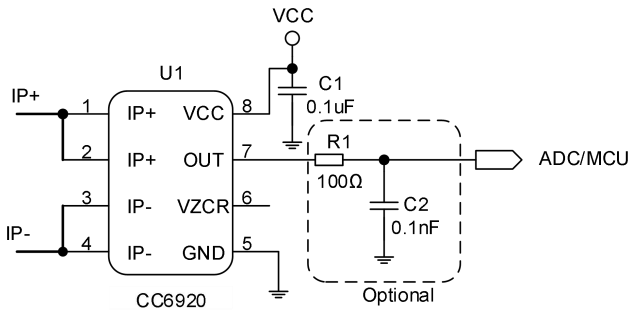

Typical Output Application

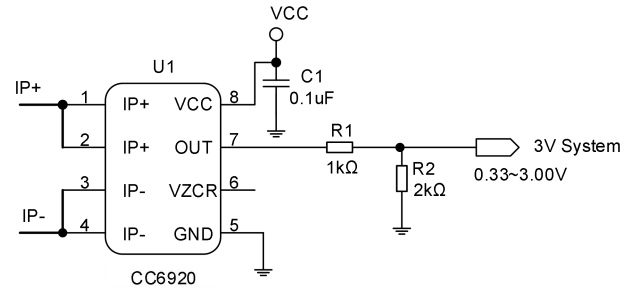

Signal Attenuation Circuit

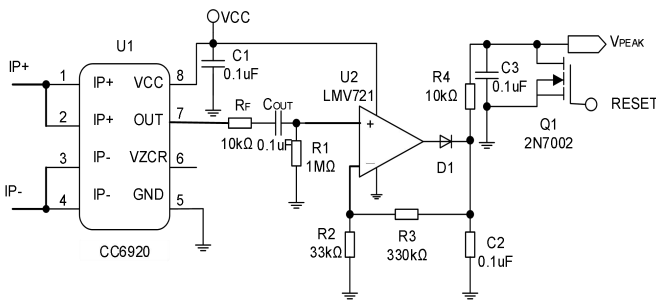

Peak Current Detection

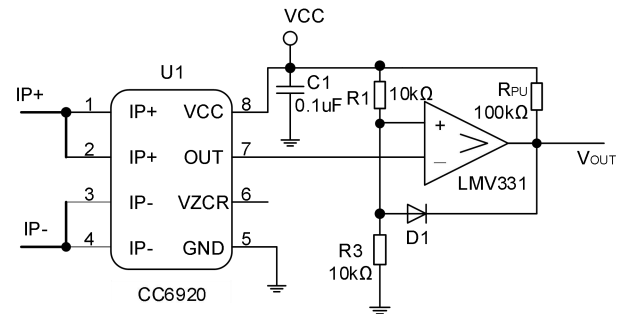

Over Current Fault Latch

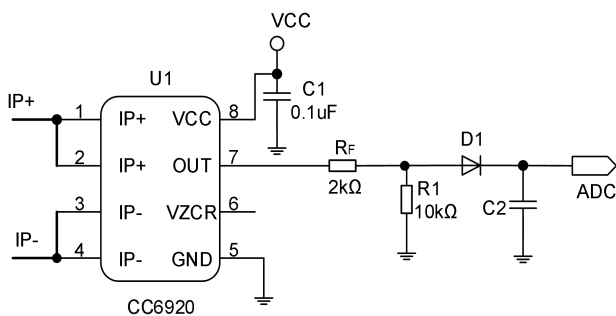

Rectifier output, instead of current transformer application

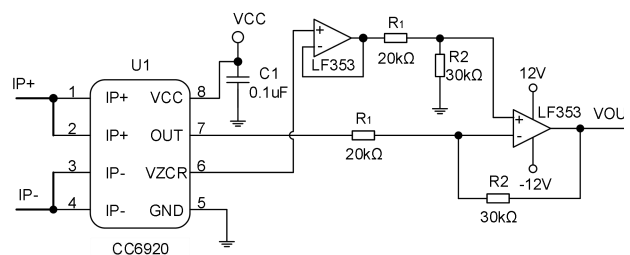

Zero Migration Application

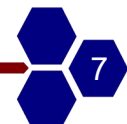

TYPICAL APPLICATION CIRCUITS

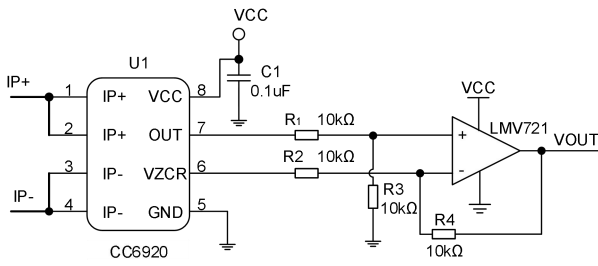

Application of single source zero shift with unidirectional current

Note: the output current of IZCR is < 0.4mA. It is suggested that 0.3mA should be reserved in design

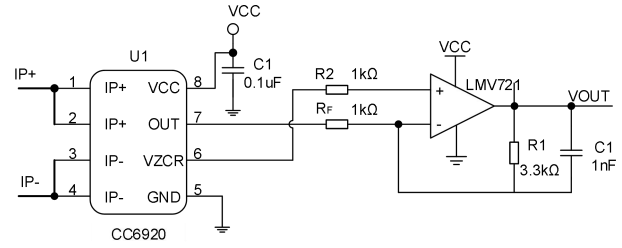

Gain amplifier application

Note: output direction of VOUT

FUNCTION DESCRIPTION

The CC6920 device is a precision current sensor based on Hall sensor. It has 424V_{RMS} basic isolated working voltage, less than 3% full scale error and zero current reference signal output in the whole temperature range, which can realize unidirectional or bidirectional current detection. The input current flows through a wire between isolated input current pins, which has a resistance of 0.9 mΩ at room temperature to reduce insertion loss. The magnetic field generated by the input current is sensed by Hall sensor and amplified by precise signal chain. It can be used for AC and DC current measurement with a bandwidth of 250kHz. The measuring current is 2.5A ~ 50A. There are 8 kinds of Current sensing range to choose. It can work under single power supply of 4.5V to 5.5V. CC6920 is optimized for high accuracy and temperature stability, compensating for misalignment and sensitivity over the entire range.

The input current of CC6920 flows through the primary side of the package through IP + and IP – pins, the current flowing through the chip generates a magnetic field proportional to the input current and is measured by an isolated Precision Hall sensor IC. Compared with other current measurement methods, the low impedance lead frame path reduces power consumption and does not require any external devices on the primary side. In addition, the internal integrated differential common mode suppression circuit can make the chip output not affected by external interference magnetic signal, and only measure the magnetic field generated by the input current, so as to suppress the interference of external magnetic field.

The typical resistance of the primary current input conductor at 25 ° C is 0.9 mΩ. The lead frame is made of copper. The temperature coefficient of the input wire is positive, and the wire resistance increases with the increase of temperature. The typical temperature coefficient is 3300 ppm/° C. For every 100 ° C increase in temperature, the primary side resistance will increase by 33%.

INPUT CURRENT

In use, the primary side of the chip (package pins 1-4) is connected in series at any position in the whole circuit. The input current flowing from IP + (package pins 1-2) to IP - (package pins 3-4) is positive, otherwise it is negative. Do not shunt resistors between IP + and IP -, unless there are very special reasons - such as minimizing insertion loss - which will reduce the current flowing through the chip, and the wire resistance will also be affected by temperature drift, which requires external temperature and precision correction of the whole system.

OUTPUT CHARACTERISTIC

The static output point (IP = 0A) of CC6920 is $V_{CC} / 2$.

When the current increases, the V_{OUT} increases until the saturation voltage of the output operational amplifier ($V_{CC} - \text{rail voltage}$); when the current decreases, the V_{OUT} decreases until the saturation voltage ($GND + \text{rail voltage}$) of the Output Op Amp. Crosschip ensures the accuracy and linearity of V_{OUT} in the range of 0.5 ~ 4.5V. In order to ensure the consistency of mass manufacturing, there is a certain margin in this range, but it is not recommended for customers to use this margin.

When the input current exceeds the range, the output of V_{OUT} is close to the rail voltage of the power supply. When the input current does not exceed the tolerance limit of the chip, the voltage will always be maintained. After the input current returns to the range, the output of V_{OUT} will return to normal without any damage to the chip.

Product Name	Input Current	Sensitivity (mV/A)	Calculation Formula (Note 1)
CC6920SO-2.5A	-2.5A ~ +2.5A	800	$V_{OUT} = V_{CC} / 2 + 0.800 \times I_P(A) \dots (V)$
CC6920SO-5A	-5A ~ +5A	400	$V_{OUT} = V_{CC} / 2 + 0.400 \times I_P(A) \dots (V)$
CC6920SO-10A	-10A ~ +10A	200	$V_{OUT} = V_{CC} / 2 + 0.200 \times I_P(A) \dots (V)$
CC6920SO-20A	-20A ~ +20A	100	$V_{OUT} = V_{CC} / 2 + 0.100 \times I_P(A) \dots (V)$
CC6920SO-25A	-25A ~ +25A	80	$V_{OUT} = V_{CC} / 2 + 0.080 \times I_P(A) \dots (V)$
CC6920SO-30A	-30A ~ +30A	67	$V_{OUT} = V_{CC} / 2 + 0.067 \times I_P(A) \dots (V)$
CC6920SO-40A	-40A ~ +40A	50	$V_{OUT} = V_{CC} / 2 + 0.050 \times I_P(A) \dots (V)$
CC6920SO-50A	-50A ~ +50A	40	$V_{OUT} = V_{CC} / 2 + 0.040 \times I_P(A) \dots (V)$

Note: the formula is only applicable to DC current calculation. When AC current is applied, pay attention to $I_{PEAK} = 1.414 \times I_{RMS}$ and the positive & negative current direction.

Relationship between Package Temperature & Input Current

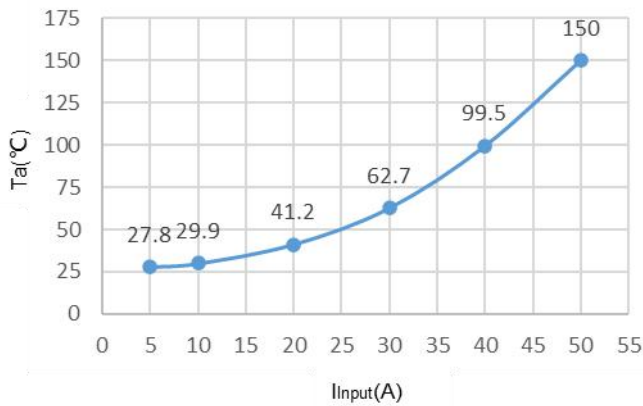

Input Current (IP) vs. Package temperature

Note: Based on the demo board test, for specific applications, it is necessary to strengthen the heat dissipation according to the actual application scenario or select the board with high Tg.

For example: Temperature tests shall be considered for the specific installation conditions in end system which needs a cooling system that can provide wind speeds of at least 10.8 m/s.

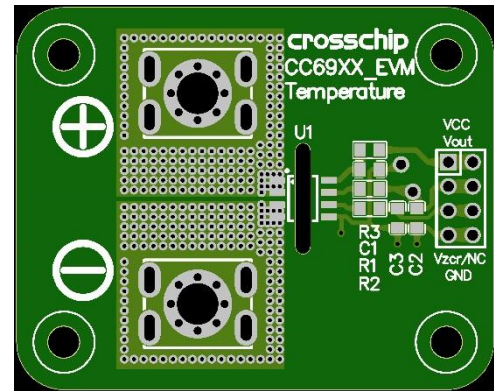

Thickness: 1.6mm, FR-4 double-sided plate, 2oz copper foil total 1200m2

Test environment: open environment, stagnant air

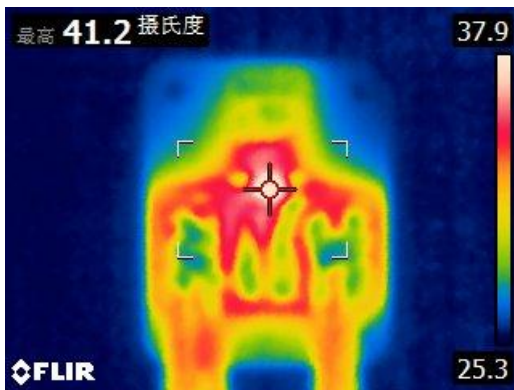

Package Thermography (Input Current 20A)

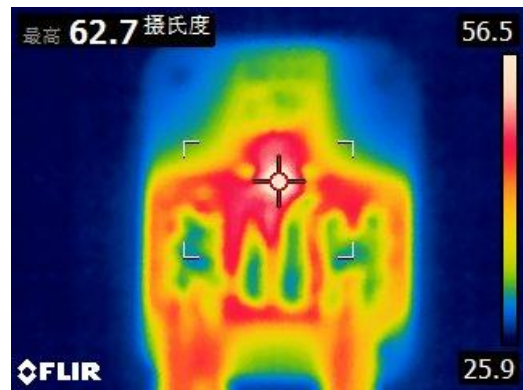

Package Thermography (Input Current 30A)



Package Thermography (Input Current 40A)

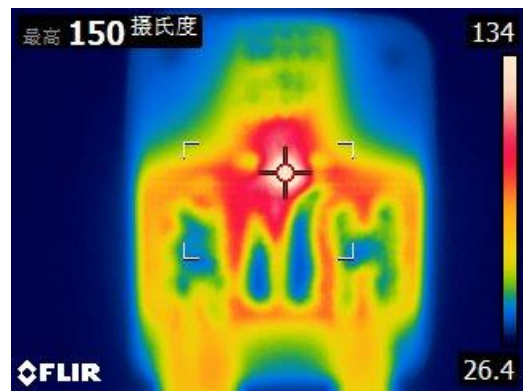

Package Thermography (Input Current 50A)

OUTPUT WAVEFORMS AND CURVES

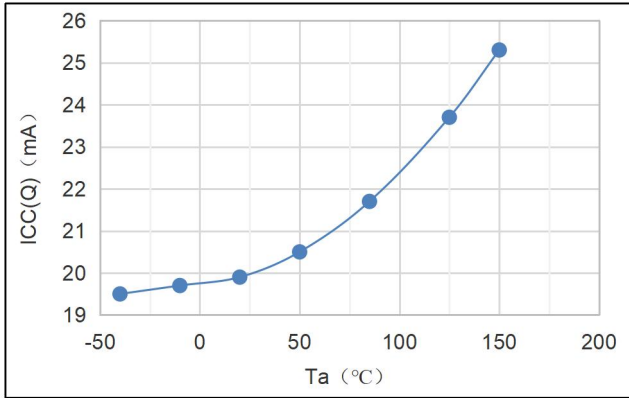

ICC vs. Ta

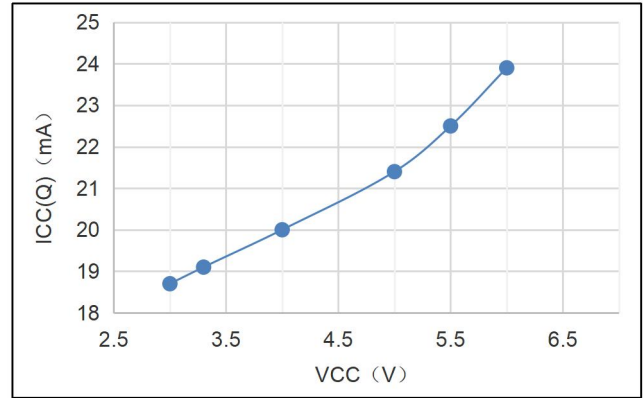

ICC vs. VCC

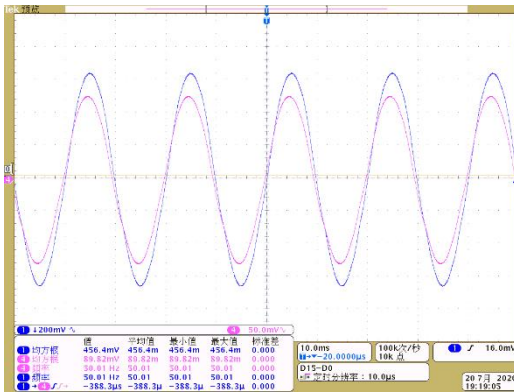

AC output voltage waveform (50Hz)

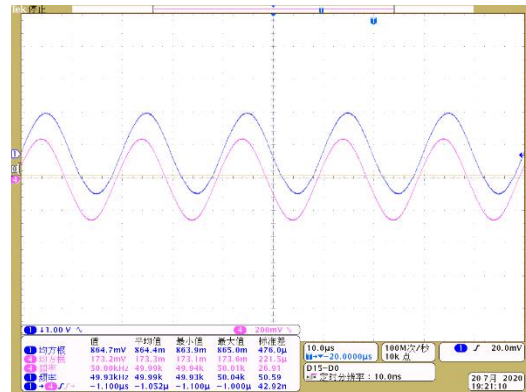

AC output voltage waveform (50kHz)

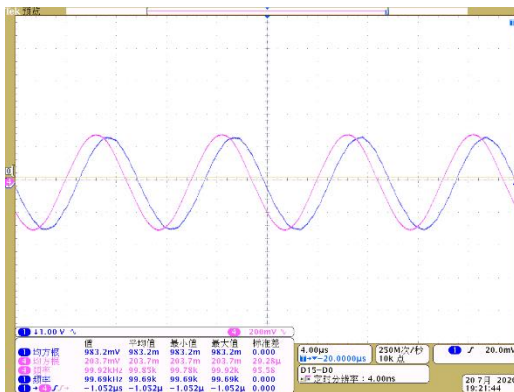

AC output voltage waveform (100kHz)

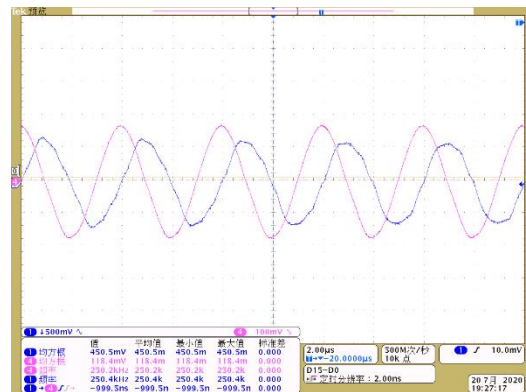

AC output voltage waveform (250kHz)

OUTPUT WAVEFORMS AND CURVES

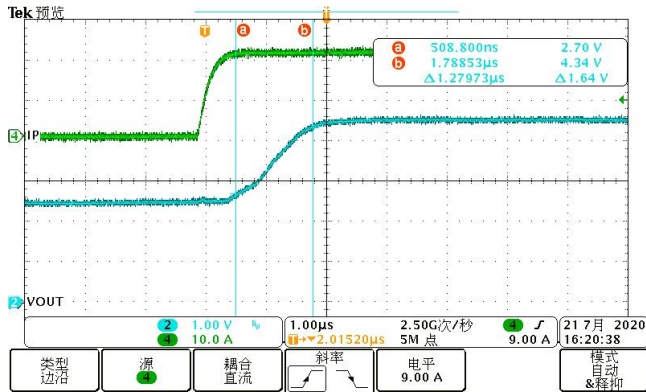

V_{OUT} vs IP (20A)

(Positive Current Rising Edge Response)

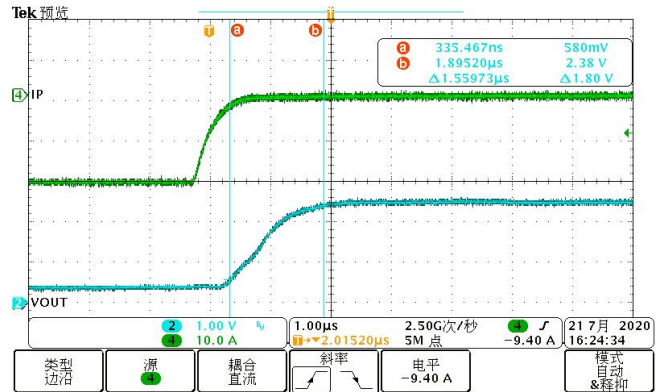

V_{OUT} vs IP (20A)

(Negative Current Rising Edge Response)

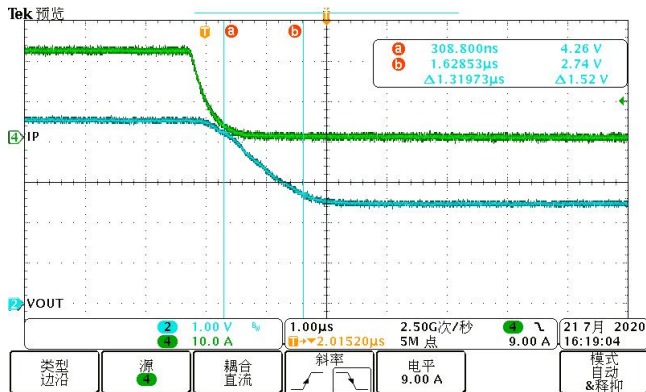

V_{OUT} vs IP (20A)

(Positive Current Falling Edge Response)

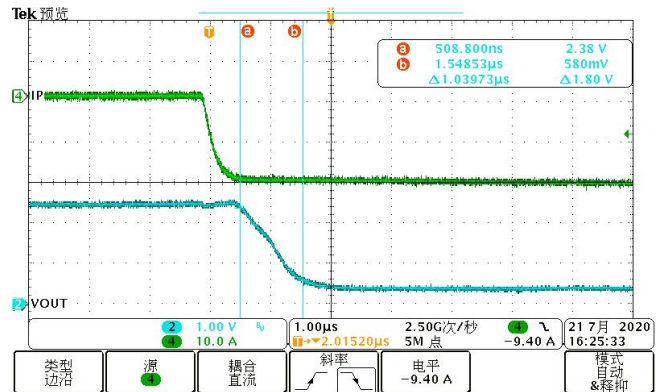

V_{OUT} vs IP (20A)

(Negative Current Falling Edge Response)

OUTPUT WAVEFORMS AND CURVES

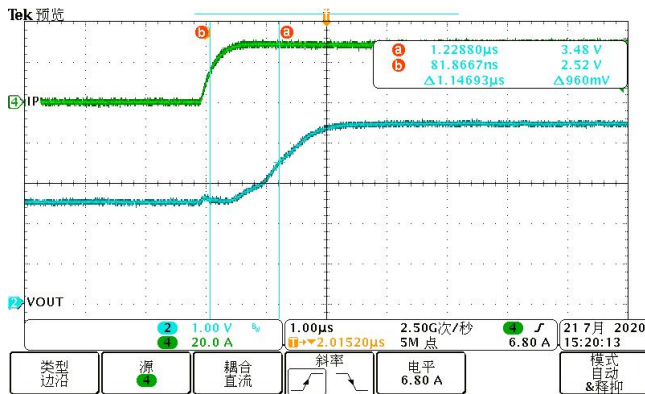

V_{OUT} vs IP (30A)

(Positive Current Rising Edge Response)

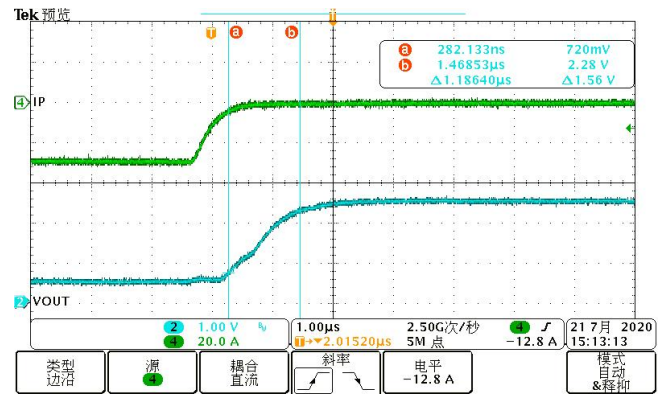

V_{OUT} vs IP (30A)

(Negative Current Rising Edge Response)

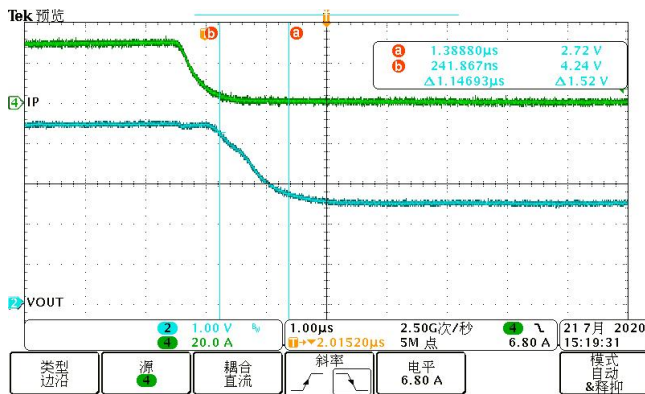

V_{OUT} vs IP (30A)

(Positive Current Falling Edge Response)

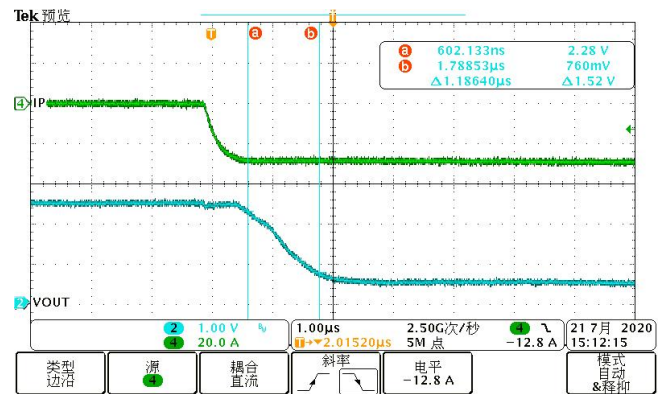

V_{OUT} vs IP (30A)

(Negative Current Falling Edge Response)

OUTPUT WAVEFORMS AND CURVES

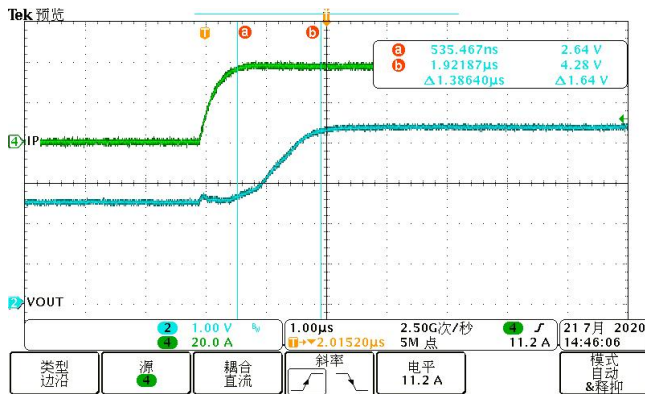

V_{OUT} vs IP (40A)

(Positive Current Rising Edge Response)

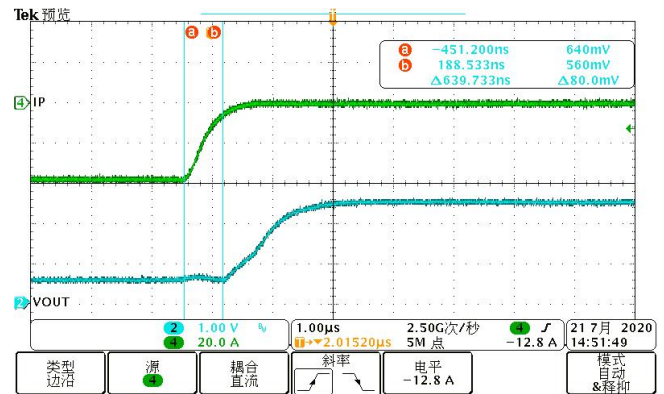

V_{OUT} vs IP (40A)

(Negative Current Rising Edge Response)

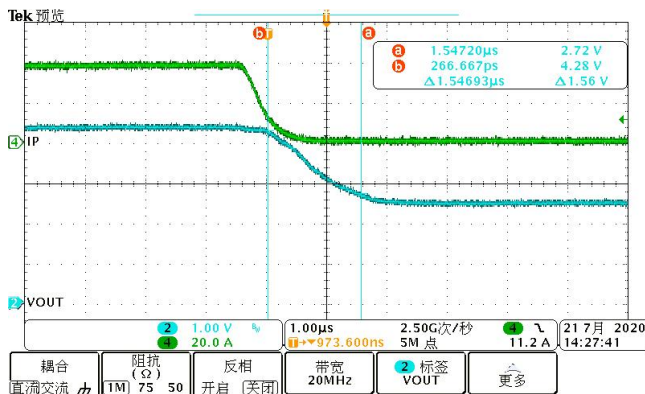

V_{OUT} vs IP (40A)

(Positive Current Falling Edge Response)

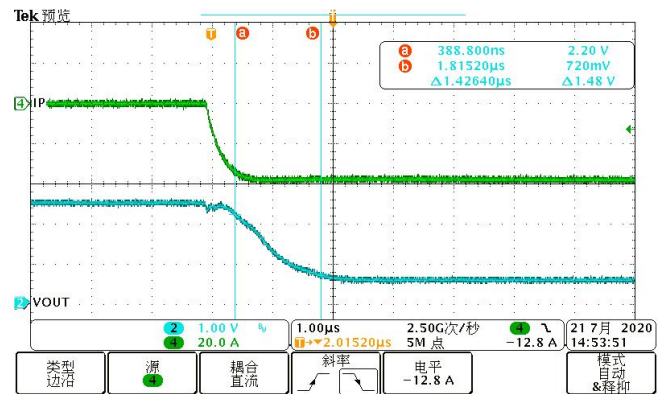

V_{OUT} vs IP (40A)

(Negative Current Falling Edge Response)

20A

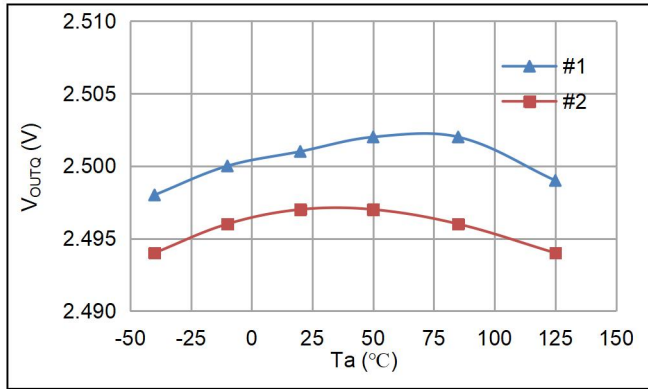

V_{OUTa} vs. T_a

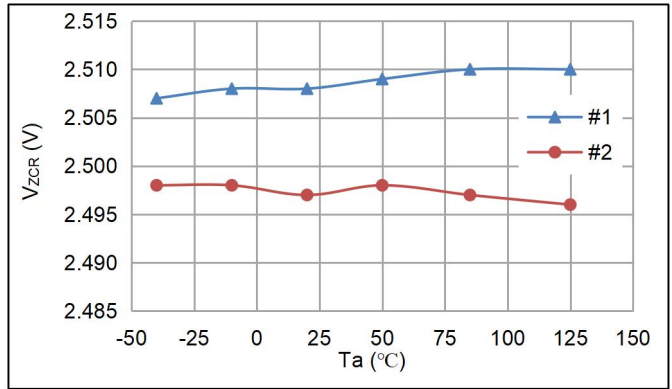

V_{ZCR} vs. T_a

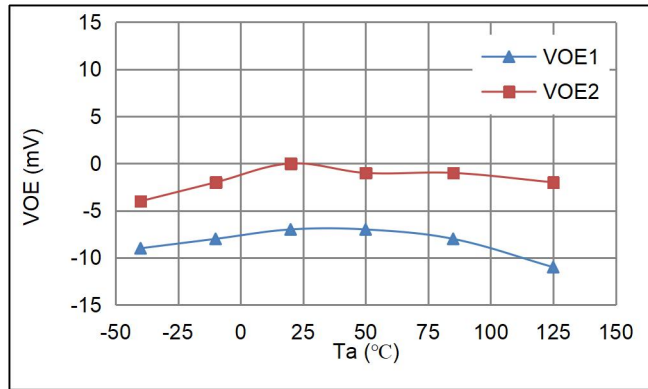

V_{OE} vs. T_a

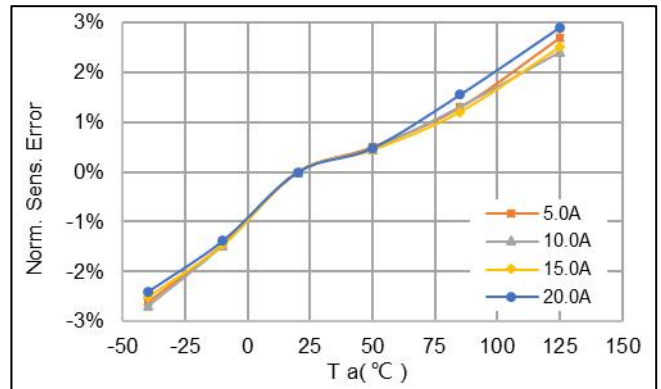

Sens error vs. T_a

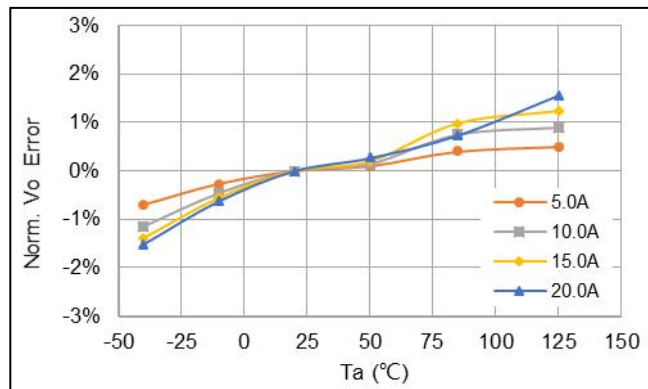

V_{OUT} error vs. T_a

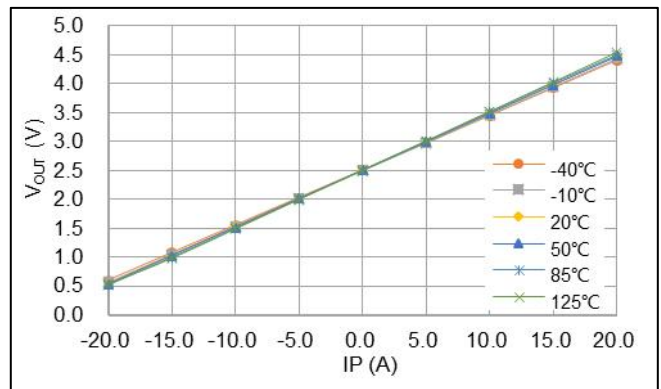

V_{OUT} vs. I_P

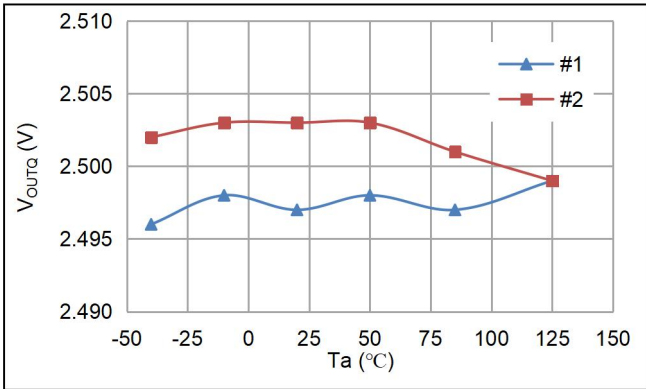

V_{OUTQ} vs. T_a

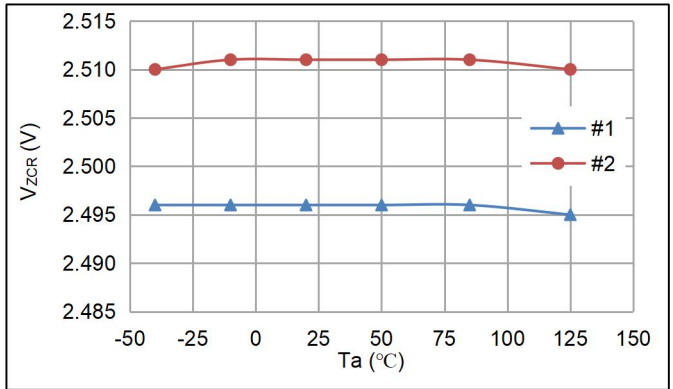

V_{ZCR} vs. T_a

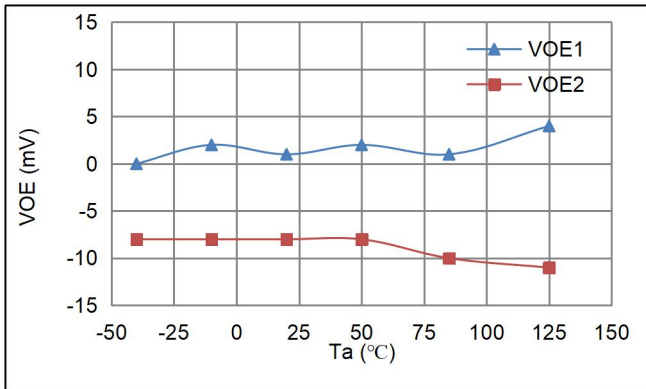

V_{OE} vs. T_a

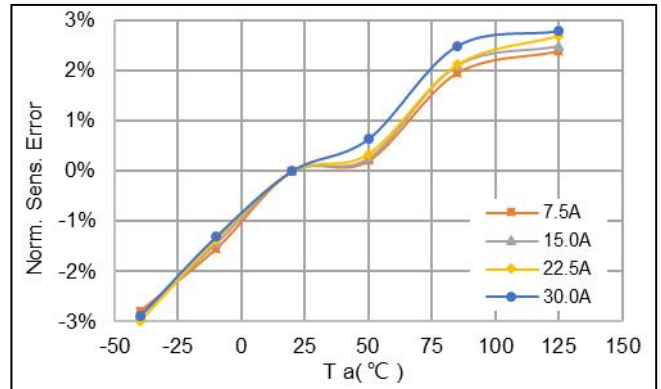

Sens error vs. T_a

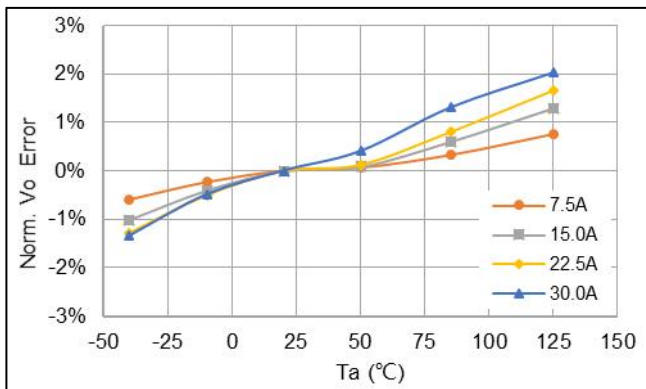

V_{OUT} error vs. T_a

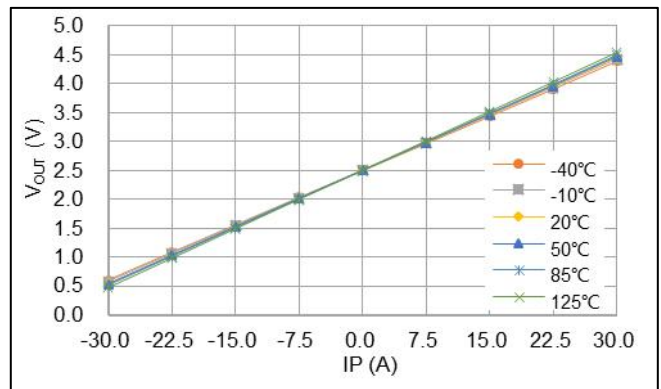

V_{OUT} vs. I_P

40A

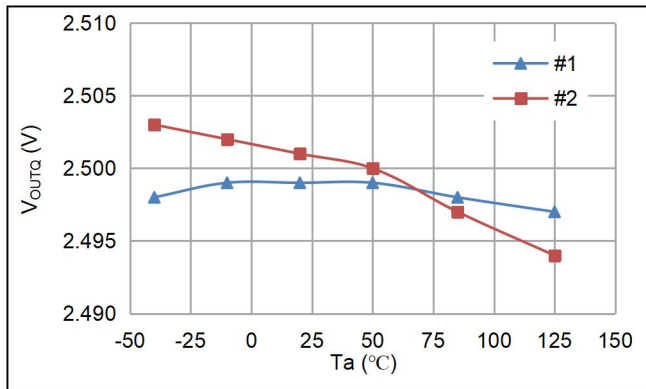

V_{OUTQ} vs. T_a

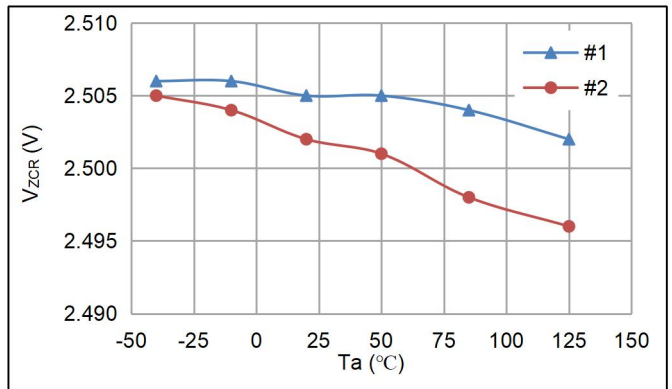

V_{ZCR} vs. T_a

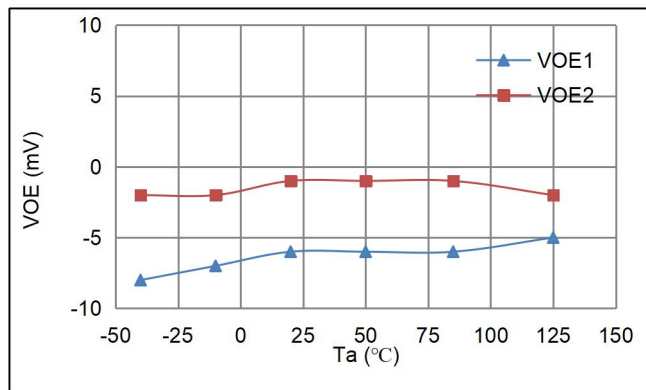

V_{OE} vs. T_a

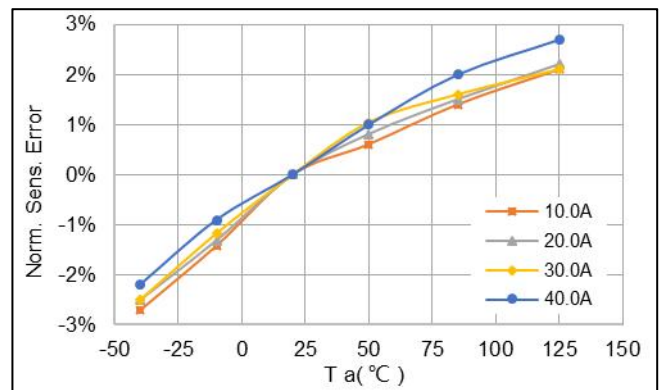

Sens error vs. T_a

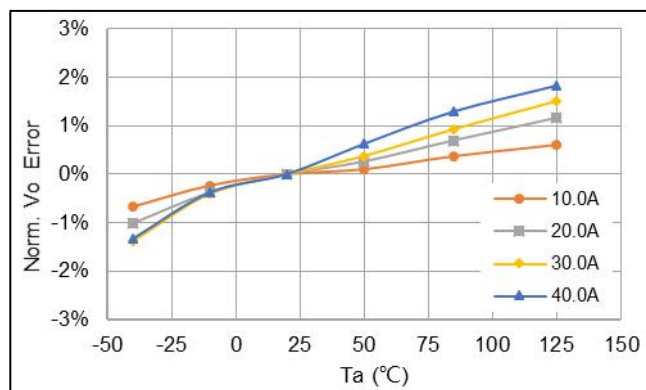

V_{OUT} error vs. T_a

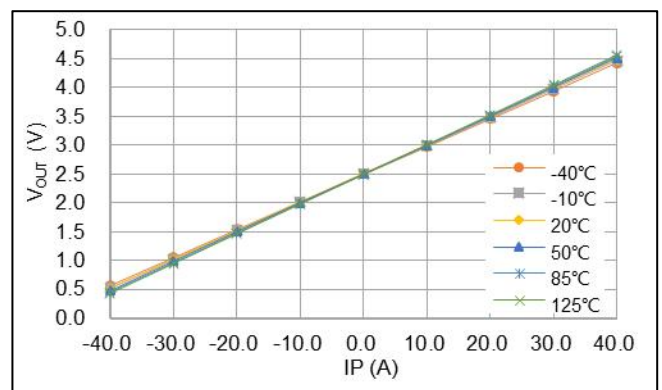

V_{OUT} vs. I_P

PACKAGE INFORMATION

SOP8 PACKAGE

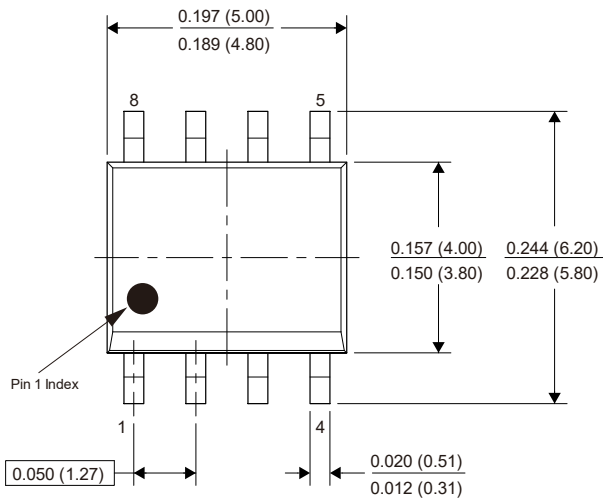

Note:

1. All dimensions are in millimeters.

Marking:

1st Line: CC6920SO - Device Name

2nd Line: ELC - XX A - I_P Range XX A

3rd Line: XXYYWW

XX – assembler code

YY – assembly year (last 2 digits)

WW – assembly week number

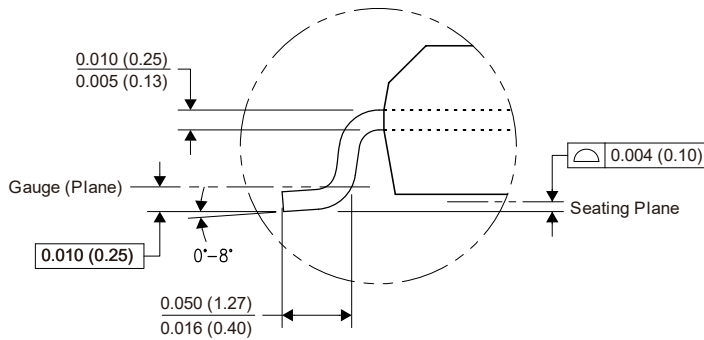
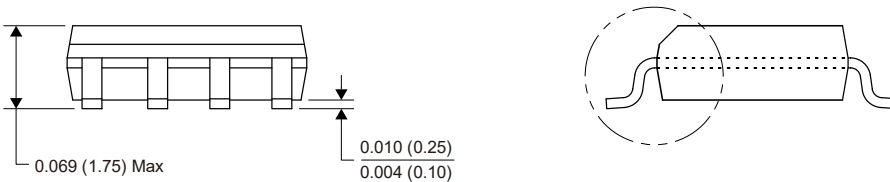

Package Reference

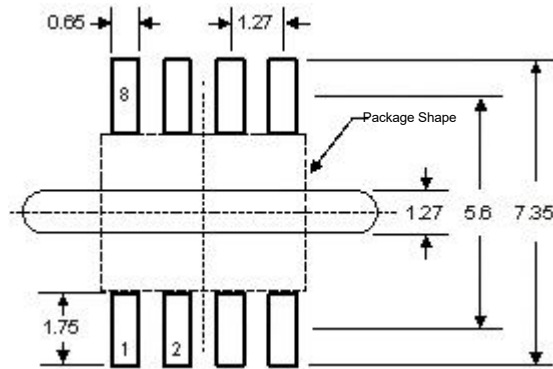

Reference 1: PCB slotting increases creepage distance

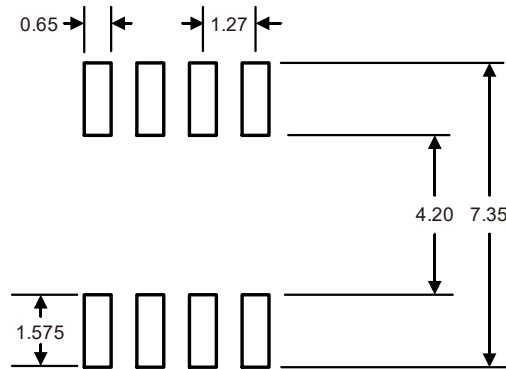

Reference 2: shorten pad length and increase creepage distance

Packaging & Taping

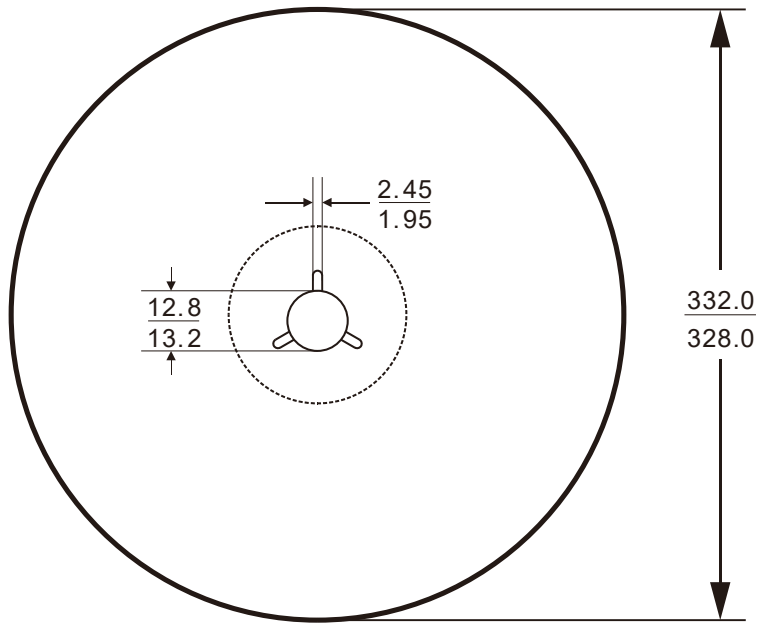

Information of Reel size

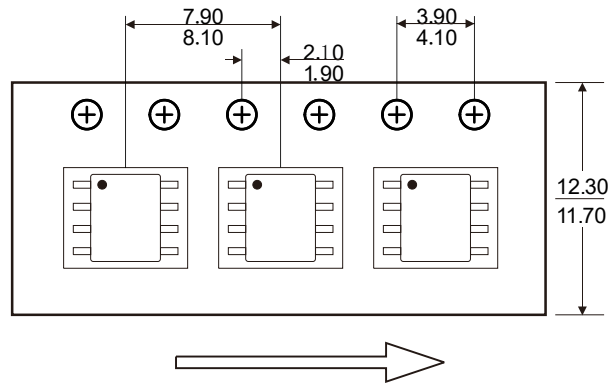

User Direction of Feed

Note: The space between the front and back of each tape is 50 ± 2 grids

REVISION HISTORY

Revision Date	Description of Revision	Revision
2024.08.27	<ol style="list-style-type: none">Delete the parameter V_{ZCR} from the ELECTRICAL CHARACTERISTICS table;ESD (HBM) updated from 4kV to 6kV; supplemental ESD (CDM) and LU.	rev2.5

CrossChip

CrossChip Microsystems Inc. was founded in 2013, is a national high-tech enterprise, engaged in integrated circuit design and sales. The company has strong technical strength, has more than 60 kinds of patents, mainly used in Hall sensor signal processing, with the following product lines:

- ✓ High precision linear Hall sensor
- ✓ All kinds of Hall switches
- ✓ Single phase motor drive
- ✓ Single chip current sensor
- ✓ AMR Magnetoresistance sensor
- ✓ Isolation drive class chip

Contact us

Chengdu

Address: 4th floor, unit 2, building 3, No. 88, Tianchen Road, Gaoxinxi Zone, Chengdu, Sichuan Province

Tel: + 86 - 028 - 87787685

Email: support@crosschipmicro.com

Website: <https://www.crosschipmicro.com>

Shenzhen

Address: 605 room, 6F, Beike building, NO.18 Keyuan Rd, Yuehai Street, Nanshan District, Shenzhen

Shanghai

Address: Room 602, Building 1, Shengda Tiandi Yuanchuanggu, No. 88, Shengrong Road, Pudong New District, Shanghai

Suzhou

Address: NO.78 Jinshan Rd East, Suzhou High-tech Zone, Huqiu District, Suzhou City, Jiangsu Province