

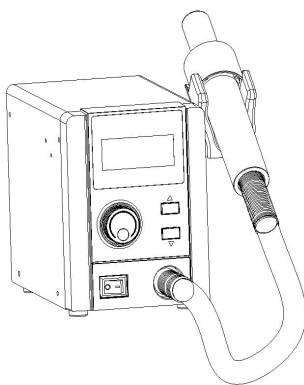

QUICK 957D+ REWORK STATION

Instruction Manual



Thank you for purchasing our products. Please keep the instruction manual properly for future reference.

Contents

1. Safety Instructions.....	1
2. Overview.....	2
3. Product Characteristics.....	2
4. Product Specifications.....	2
5. Functional Descriptions.....	3
5.1. Dimensions.....	3
5.2. Part Descriptions.....	3
5.3. Function Descriptions of the Main Interface.....	4
6. Installation and Connection.....	5
6.1. Installation of Rework Station.....	5
6.2. Connection of Main Unit.....	5
7. Operation.....	6
8. Password Settings.....	6
9. Parameter Settings.....	7
10. New Passwords Settings.....	8
11. Temperature Calibration.....	8
12. Replacing the Heater.....	9
12.1. Steps of Removing the Heater.....	9
12.2. Steps of Replacing the Heater.....	10
13. Troubleshooting.....	11
14. Selection of Nozzles.....	12

1.Safety Instructions



CAUTION

- During the installation and use of this product, all electrical safety regulations of the country and regions must be strictly observed.
- The power supply must be disconnected when disassembling the product. Do not operate with power on.
- If the product does not work properly, please contact the supplier or our company, and do not disassemble or change the product in any way. We are not responsible for any problems caused by unauthorized maintenance or modification.



WARNING

- Don't install the product in a place where the surface is easy to shake or be impacted, as it may damage the product.
- Don't place the product in places where it may be exposed to rain or moisture.
- The product should be used away from places where there is magnetic interference.
- Don't use in flammable and explosive environments.
- Pay attention to the air outlet and its surroundings. High temperature operation, be careful of burns.
- Power supply should be turned off during breaks or after work to avoid safety accidents.
- Please keep the air outlet unblocked and ensure there is no obstruction.
- Check and maintain the product regularly. Do not use the product when it is damaged, especially when the power cord is damaged.
- The handle must be correctly placed on the holder, and do not replace it on the work surface.After completion,turn off the power switch when the machine automatically cools down to below 100°C (Enter Sleeping state).
- When the machine is not used for a long time, please unplug the power cord.

2.Overview

This product is used to rework various components, such as SMD, SOP, SOG, etc. It can be used in different applications, such as heat shrinkage, drying, paint removal, adhesive removal, thawing, preheating, disinfection, etc. Adjustable air volume, suitable for small air volume and large air volume heating occasions.

3.Product Characteristics

- Closed loop sensor, temperature can be controlled by zero voltage triggering mode and adjusted conveniently, accurate and stable, large power, rapid heating.
- Stepless adjustable airflow, with a large range; digital temperature display, easy temperature adjustment, suitable for various occasions.
- Equipped with a sensitive magnetic control sensor. Pick up the handle, the system enters the working mode; put the handle back to the holder, the system enters the standby state.
- Compact body, occupy small space.

4.Product Specifications

Product model	957D+
Display	LCD
Power	580W(Max)
Working	AC 220V
Temperature	100~500°C
Airflow range	1~100 Class
Max airflow	40L/min
Dimensions(L*	110*180*151mm
Weight	About 1.6 kg

5.Functional Descriptions

5.1.Dimensions

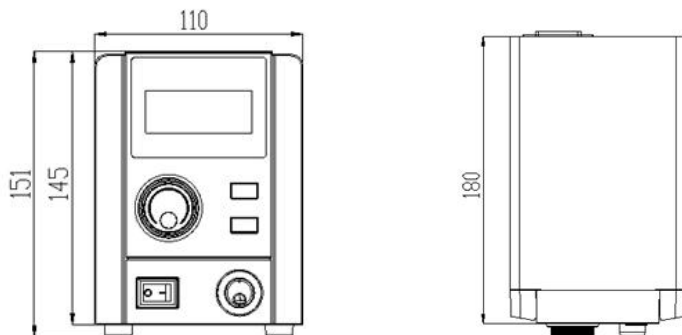

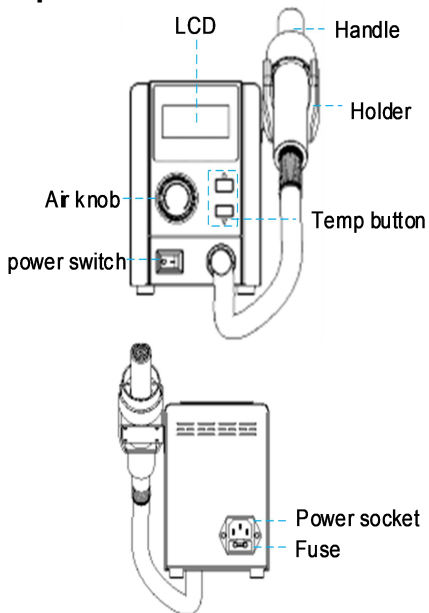

Unit: mm

5.2.Part Descriptions

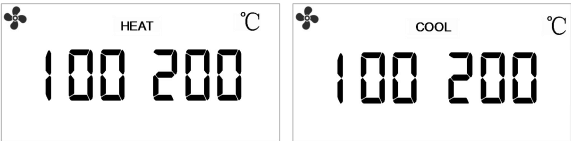

5.3.Function Descriptions of the Main Interface



Symbols	Descriptions
	Air volume
HEAT	Heating state
COOL	Cooling state

6.Installation and Connection

6.1.Installation of Rework Station

When the station is used for the first time, the hot air holder must be installed, as shown in the figure below.

- 1) Remove the two screws on the left side of the machine that fixed the holder.
- 2) Align the mounting hole of the hot air desoldering holder with the two screw holes on the machine, and tighten the two screws that are removed.
- 3) Install the hot air desoldering holder, place the handle on the holder, and check whether it is suitable.

Note: The hot air handle holder can be installed on the left or right side of the system according to actual needs.

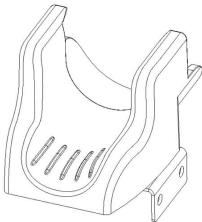

6.2.Connection of Main Unit

Connect the power supply to the station, turn on it and start working.

7.Operation

Airflow Adjust the air knob clockwise to increase the airflow, otherwise decrease the air volume. Adjust the air knob in a wide range to quickly increase or decrease the airflow.

Temperature Press " ▲ " or " ▼ ": temperature increases or decreases by 1 °C. Long press " ▲ " or " ▼ ": temperature increases or decreases rapidly.

Sleeping Put the handle on the handle holder, and the system will automatically enter the large air volume cooling state; when the temperature drops to 100 °C, the system will immediately enter the sleeping state.

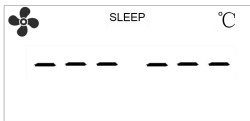

8.Password Settings

The initial password is "000", and in this state, you can set the temperature. If you need to limit the temperature adjustment, you must change the password.

Enter password setting mode

- 1) Turn off the station, press the " ▲ " and " ▼ " keys at the same time, and then turn on the station.
- 2) Long press the " ▲ " and " ▼ " keys, "C" will be displayed after a beep sound, and the "---" display on the interface.
- 3) After input the correct password, go to parameter setting.

Input the initial password

- 1) The screen shows "- - -" and the hundreds digit flashes, at this time the digit can be adjusted (enter the initial password).
- 2) Input the original password: adjust the air knob to change the hundreds digit number, press the "▲" key to select the digit, when the tens digit starts to flash, it can be set. The setting method of the tens digit and one digit are the same as the hundreds digit. When the one digit setting is completed, press and hold the "▲" and "▼" keys at the same time to confirm the setting.
- 3) **If the first password is wrong:** directly enter the second password input mode, and the password input way is the same as the first time. (There are two chances of password input.)
- 4) **If the password entered twice is wrong:** the screen display "ERR", and directly to the main interface.
- 5) **If the first or second password is correct:** go directly to parameter setting and the screen display "-1-".

9.Parameter Settings

- 1) If password is input correctly, the parameter menu can be entered, as shown in the following figure

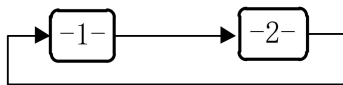

- 2) Press the "▲" or "▼" key, after selecting the -1-parameter menu, press the "▲" and "▼" keys at the same time to return to the main interface; after selecting the parameter menu -2-, press the "▲" and "▼" keys at the same time to enter the new password setting.

10. New Passwords Settings

1) After entering the new password setting, the screen shows "---" and the hundreds digit blinks.

2) Adjust the air knob to change the hundreds digit, press the "▲" button to move the digit, when the tens digit starts blinking, it can be set. The setting method of the tens and one digit is the same as that of the hundreds digit. When the one digit setting is completed, press and hold the "▲" and "▼" keys at the same time to confirm. Enter the second password input mode, and the password input way is the same as the first time.

Note: If the two passwords input are not the same, the screen will display "ERR", indicating that the password setting is unsuccessful. It will return to the parameter setting, and the password will remain unchanged.

If two passwords input are the same, the screen displays "OK", indicating that the password setting is successful, and it returns to the parameter setting. Shut down and restart the machine, the new password takes effect.

11. Temperature Calibration

1) Set the machine temperature to 300°C. Use QUICK196 to test the temperature of the air outlet and write down the readings.

2) Press and hold the "▲" and "▼" keys at the same time for about 2 seconds, the display will show "CAL" and enter the temperature calibration interface.

3) Press "▲" or "▼" to adjust the temperature to the measured value.

4) Long press the "▲" and "▼" keys at the same time for about 2 seconds, and return to the main interface with a beep. It indicates the temperature calibration is successful.

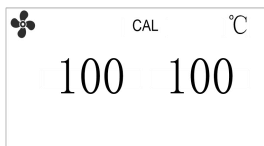

Note: If there is no QUICK196, it is recommended that the temperature measuring head of the external sensor of the thermometer be placed 3~5mm away from the nozzle for temperature test.

12.Replacing the Heater

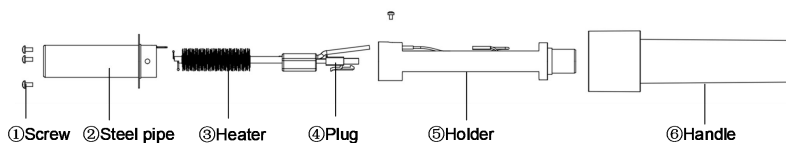

12.1.Steps of Removing the Heater

- 1) Remove the spring.
- 2) Unscrew the three ①Screws.
- 3) Pull out ②Steel pipe & ⑤Holder from ⑥Handle.
- 4) Remove the orange and yellow cables connected in the ③Heater.
- 5) Remove a screw of ②Steel pipe, **unplug** the grounding cable and remove the ②Steel pipe, Check whether the quartz tube is damaged or not.
- 6) Remove the ③Heater from ④Plug.
- 7) Remove the heater.



Note: All operating steps are performed with the power disconnected and the handle cooled.

12.2.Steps of Replacing the Heater

- 1) Insert the ③Heater, and connect it into green plug.
- 2) Connect the yellow cable into the heater of the yellow cable , and the orange into the red.
- 3) Connect the ④Plug into ⑤Holder, then cover the ③Heater with the ②Steel pipe and lock it.
- 4) Connect grounding cable and tighten it.
- 5) Install the replaced ③Heater into the ⑥ Handle, lock the three ①Screws.
- 6) Turn the spring counterclockwise until the handle is installed.
- 7) After replacing the heater, test the following parameters:

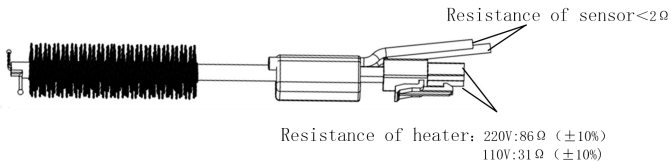

- 8) After the heater is replaced, it is recommended to calibrate the temperature. (See the hot air desoldering temperature calibration steps for details)

13.Troubleshooting

No.	Error	Fault Descriptions
1	H-E	Indicates that there is a problem with the heater and the heater needs to be checked or replaced.
2	S-E	Indicates that there is a problem with the sensor and the sensor needs to be checked or replaced.
3	F-E	Indicates that the fan is faulty and needs to be checked or replaced.

14.Selection of Nozzles

NOZZLES

NOTE

The size in Name/Specification indicates the size of IC package

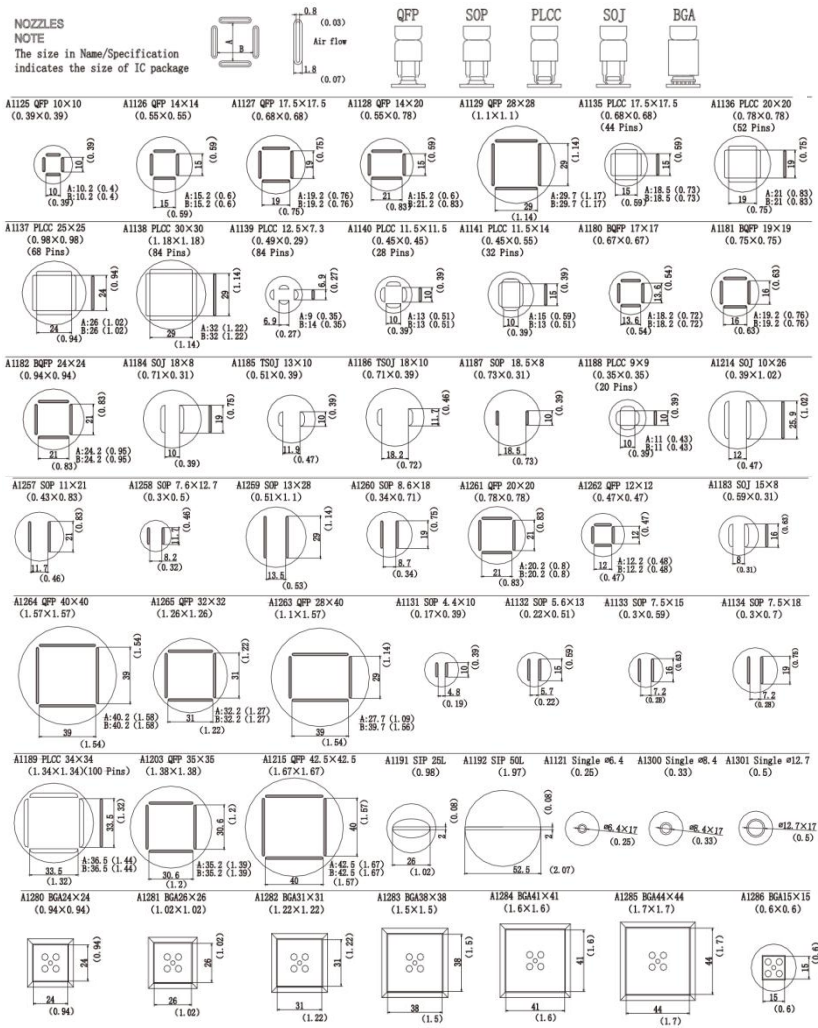

Warranty Card

●The warranty period of this product is calculated from the date of Purchase. During the warranty period, if the product breaks down during normal use, show the original warranty card and enjoy free service in the authorized repair company(or our company). Please keep the purchase certificate and this warranty card and show it before maintenance.

●During the warranty period, the following repairs need to be paid:

- a.Unable to offer valid warranty card or certificate;
- b.The purchase date, sales company and other items are not completely filled or the warranty card is altered;
- c.Damage caused by failure to follow the use methods and precautions in the manual;
- d.Damage caused by disassembly, repair and modification of products without authorization of the manufacturer;
- e.Replacement of vulnerable and consumable parts.

●All items of the warranty card shall be completely filled in by the agent or user to obtain a 12-month warranty period.

●Please keep this warranty card properly It will not be re-offered after.

QUICK INTELLIGENT EQUIPMENT
CO., LTD.

ADD: NO.11, FengXiang Road, Wujin
High-Tech Industrial Development
Zone, Jiangsu, China

TEL: 86-519-86225678

FAX: 86-519-86558599

POSTCODE: 213167

WEBSITE: www.quick-global.com

Warranty Card

Type: _____

Model No.: _____

Serial No.: _____

Delivery Date: _____

Warranty File Card

Type: _____

Model No.: _____

Serial No.: _____

Delivery Date: _____

Address : _____

Postcode: _____

Telephone: _____

Contact Person: _____

QUICK INTELLIGENT EQUIPMENT CO., LTD.

ADD: NO.11, FengXiang Road, Wujin
High-Tech Industrial Development Zone,
Jiangsu, China

TEL: 86-519-86225678

FAX: 86-519-86558599

POSTCODE: 213167

WEBSITE: www.quick-global.com

