

FEATURE

- ◆ -30V/-5.6A, $R_{DS(ON)}=37m\Omega$ (typ.) @ $V_{GS}=-10V$
- ◆ -30V/-4.3A, $R_{DS(ON)}=52m\Omega$ (typ.) @ $V_{GS}=-4.5V$
- ◆ Super high design for extremely low $R_{DS(ON)}$
- ◆ Exceptional on-resistance and Maximum DC current capability
- ◆ Full RoHS compliance
- ◆ SOT23-3L package design

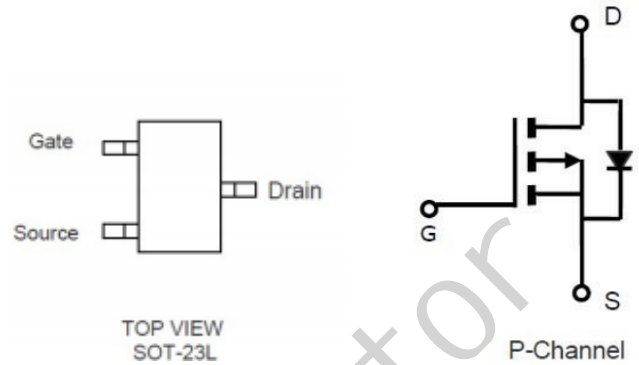

DESCRIPTION

The 2315 is the P-Channel logic enhancement mode power field effect transistor is produced using high cell density advanced trench technology to provide excellent $R_{DS(ON)}$.

This device is suitable for use as a load switch or in PWM and gate charge for most of the synchronous buck converter applications

APPLICATIONS

- ◆ High Frequency Point-of-load Synchronous
- ◆ Buck Converter for MB/NB/UMPC/VGA
- ◆ DC/DC Converter
- ◆ Load Switch

ABSOLUTE MAXIMUM RATINGS ($T_A = 25^\circ C$ Unless otherwise noted)

Symbol	Parameter		Typical	Unit
V_{DSS}	Drain-Source Voltage		-30	V
V_{GSS}	Gate-Source Voltage		± 20	V
I_D	Continuous Drain Current ($T_C=25^\circ C$)	$V_{GS}=-10V$	-5.6	A
	Continuous Drain Current ($T_C=70^\circ C$)		-5.0	
I_{DM}	Pulsed Drain Current		-20	A
I_S	Continuous Source Current (Diode Conduction)		-1.4	A
P_D	Power Dissipation	$T_A=25^\circ C$	1.4	W
		$T_A=70^\circ C$	0.9	
T_J	Operation Junction Temperature		150	$^\circ C$
T_{STG}	Storage Temperature Range		-55~+150	$^\circ C$
$R_{\theta JA}$	Thermal Resistance Junction to Ambient		120	$^\circ C/W$

Note: Absolute maximum ratings are those values beyond which the device could be permanently damaged. Absolute maximum ratings are stress rating only and functional device operation is not implied

■ ELECTRICAL CHARACTERISTICS ($T_A=25^\circ\text{C}$ Unless otherwise noted)

Symbol	Parameter	Condition	Min	Typ	Max	Unit
Static Parameters						
$V_{(BR)DSS}$	Drain-Source Breakdown Voltage	$V_{GS}=0V, I_D=-250\mu A$	-30			V
$V_{GS(th)}$	Gate Threshold Voltage	$V_{DS}=V_{GS}, I_D=-250\mu A$	-1.0		-2.0	V
I_{GSS}	Gate Leakage Current	$V_{DS}=0V, V_{GS}=\pm 20V$			± 100	nA
I_{DSS}	Zero Gate Voltage Drain Current	$V_{DS}=-24V, V_{GS}=0$			-1	uA
		$V_{DS}=-24V, V_{GS}=0$ $T_J=55^\circ\text{C}$			-5	
$R_{DS(ON)}$	Drain-Source On-Resistance	$V_{GS}=-10V, I_D=-5.6A$		37	50	m Ω
		$V_{GS}=-4.5V, I_D=-4.3A$		52	75	
Source-Drain Diode						
V_{SD}	Diode Forward Voltage	$I_S=-1.0A, V_{GS}=0V$		-0.7	-1.0	V
Dynamic Parameters						
Q_g	Total Gate Charge	$V_{DS}=-20V$ $V_{GS}=-4.5V$ $I_D=-4.0A$		6		nC
Q_{gs}	Gate-Source Charge			2.7		
Q_{gd}	Gate-Drain Charge			3.1		
C_{iss}	Input Capacitance	$V_{DS}=-25V$ $V_{GS}=0V$ $f=1\text{MHz}$		645		pF
C_{oss}	Output Capacitance			272		
C_{rss}	Reverse Transfer Capacitance			105		
$T_{d(on)}$	Turn-On Time	$V_{DS}=-12V$ $I_D=-4A$		9		nS
T_r				16.5		
$T_{d(off)}$	Turn-Off Time	$V_{GEN}=-10V$ $R_G=3.3\Omega$		22		
T_f				21		

Note: 1. Pulse test: pulse width $\leq 300\mu\text{s}$, duty cycle $\leq 2\%$

2. Static parameters are based on package level with recommended wire bonding

■ **TYPICAL CHARACTERISTICS** (25°C Unless Note)

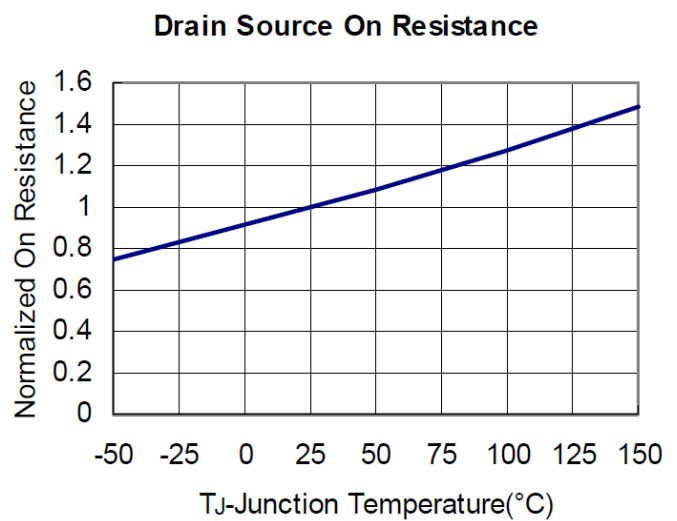
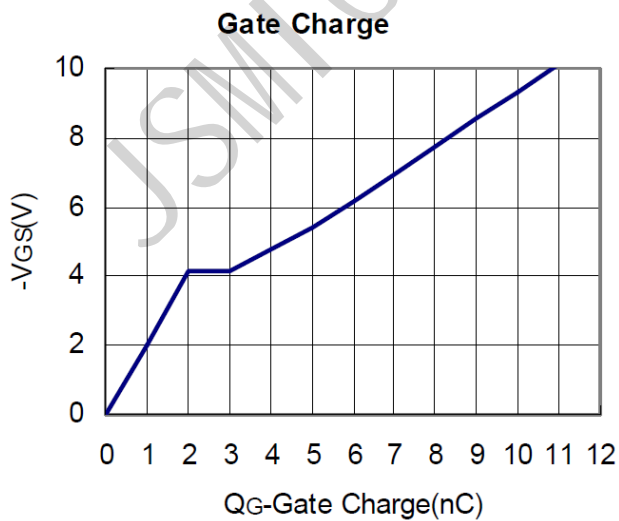
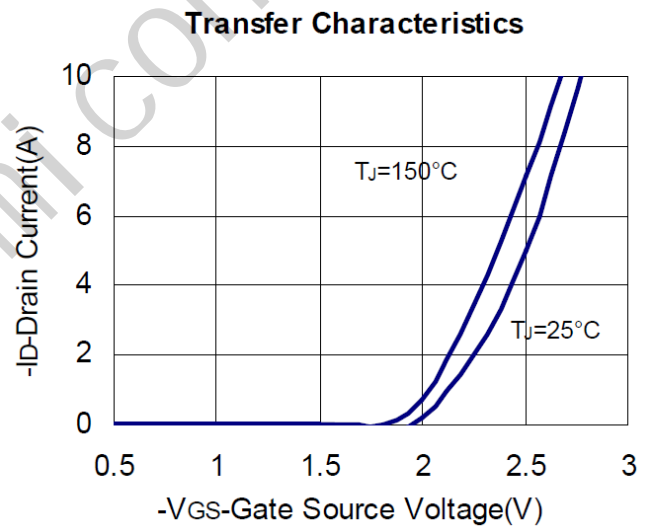
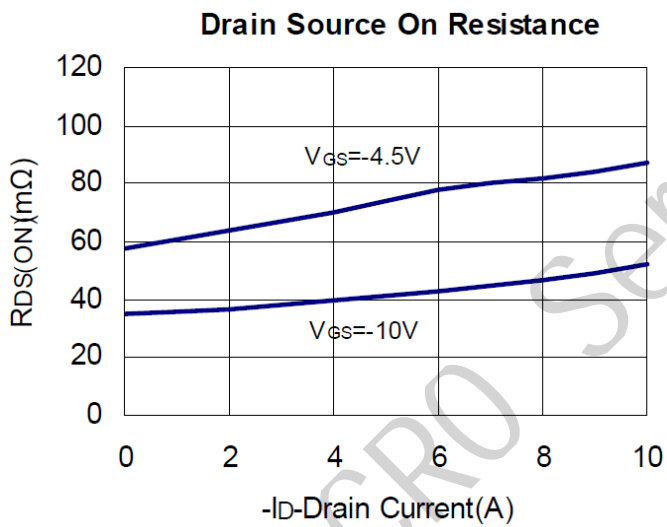
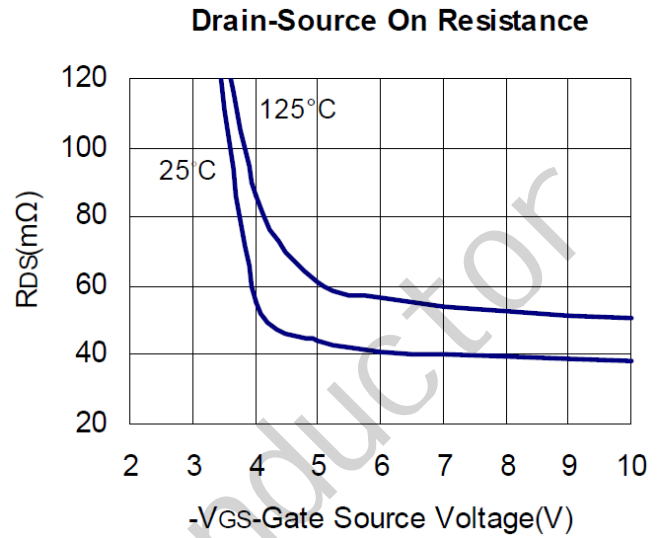
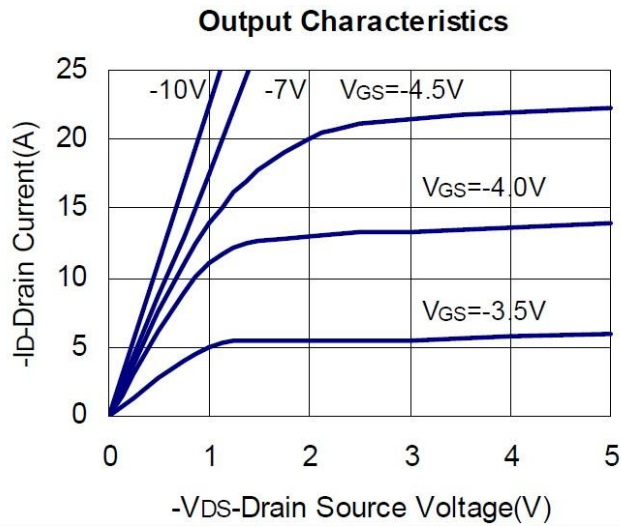

TYPICAL CHARACTERISTICS (continuous)

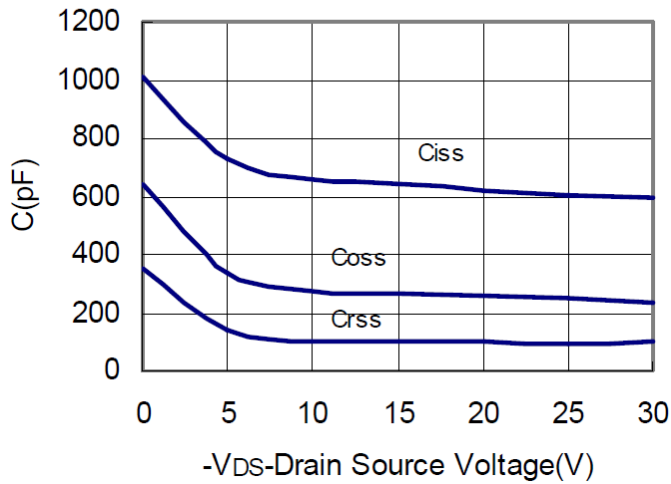
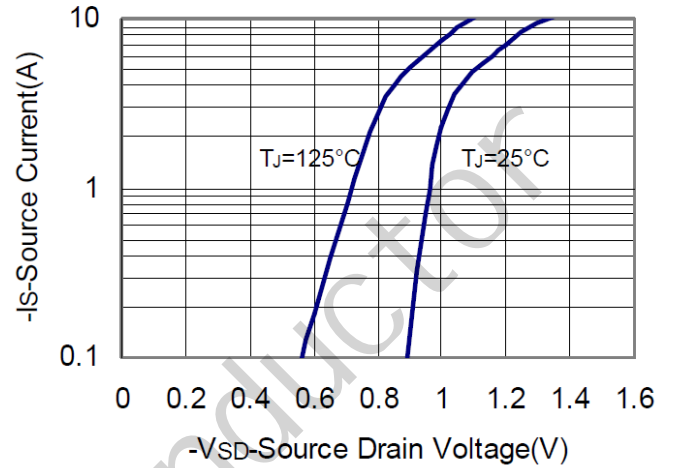
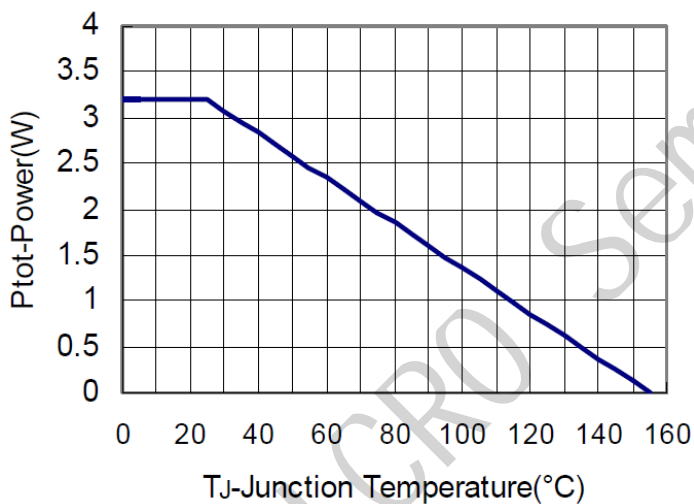
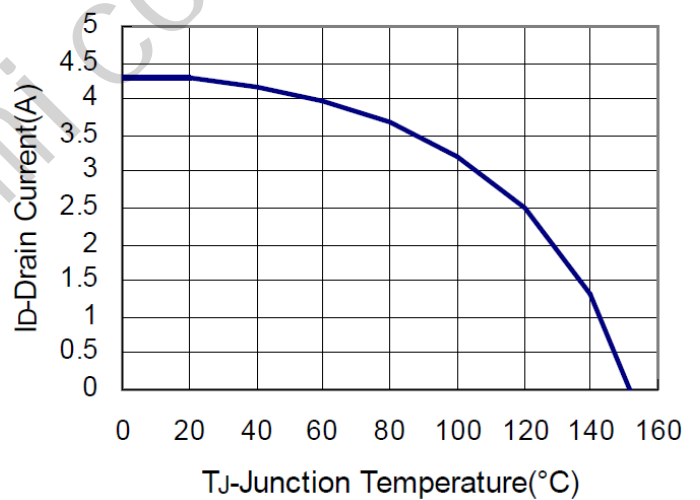
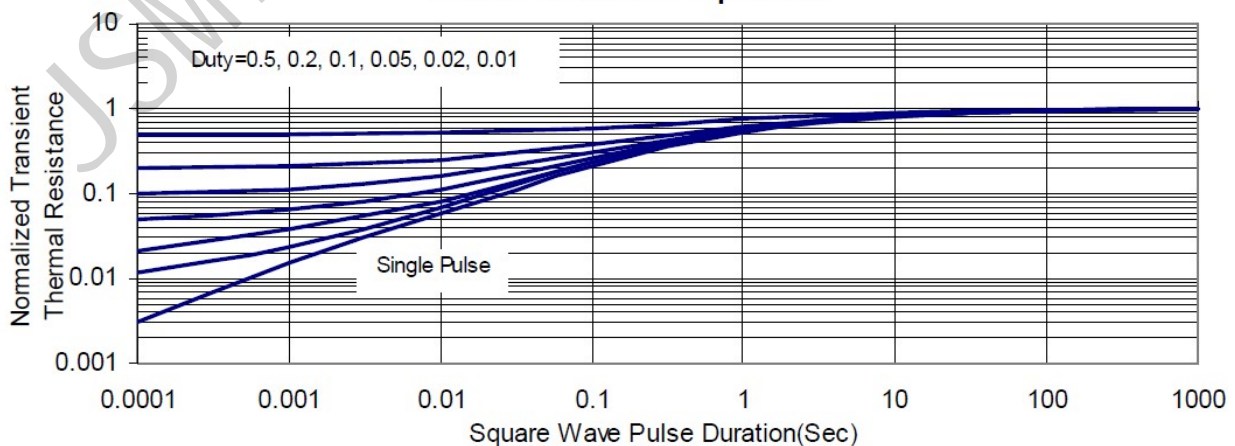
Capacitance

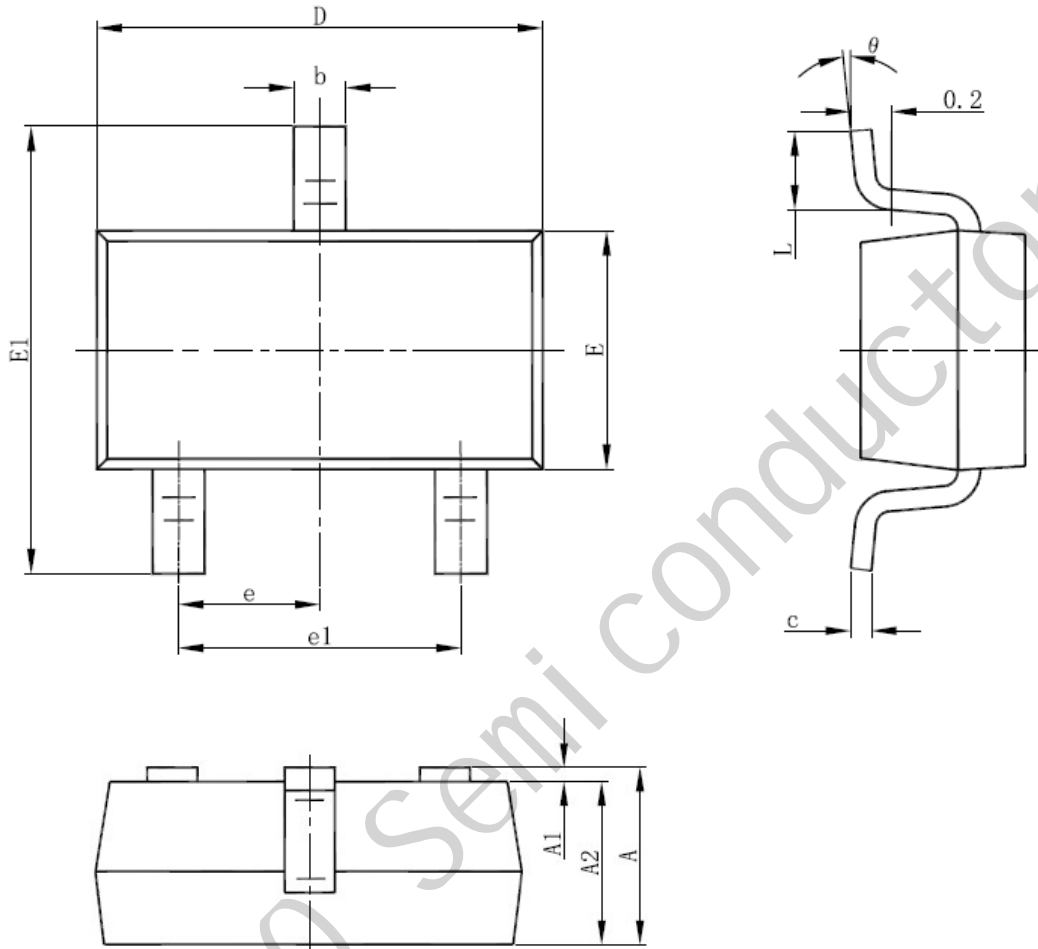
Source Drain Diode Forward

Power Dissipation

Drain Current

Thermal Transient Impedance

■ SOT23-3L PACKAGE OUTLINE DIMENSIONS

Symbol	Dimensions In Millimeters		Dimensions In Inches	
	Min	Max	Min	Max
A	1.050	1.250	0.041	0.049
A1	0.000	0.100	0.000	0.004
A2	1.050	1.150	0.041	0.045
b	0.300	0.500	0.012	0.020
c	0.100	0.200	0.004	0.008
D	2.820	3.020	0.111	0.119
E	1.500	1.700	0.059	0.067
E1	2.650	2.950	0.104	0.116
e	0.950(BSC)		0.037(BSC)	
e1	1.800	2.000	0.071	0.079
L	0.300	0.600	0.012	0.024
theta	0°	8°	0°	8°