

100751-1 ✓ ACTIVE

Z-PACK | Z-PACK 2mm HM

TE Internal #: 100751-1

Board-to-Board, 3 Position, 1 Row, 3 Column, Plug, Printed Circuit Board, Board Mount, Z-PACK 2mm HM, Backplane Connector Housings

[View on TE.com >](#)



Connectors > PCB Connectors > Backplane Connectors > Backplane Connector Housings

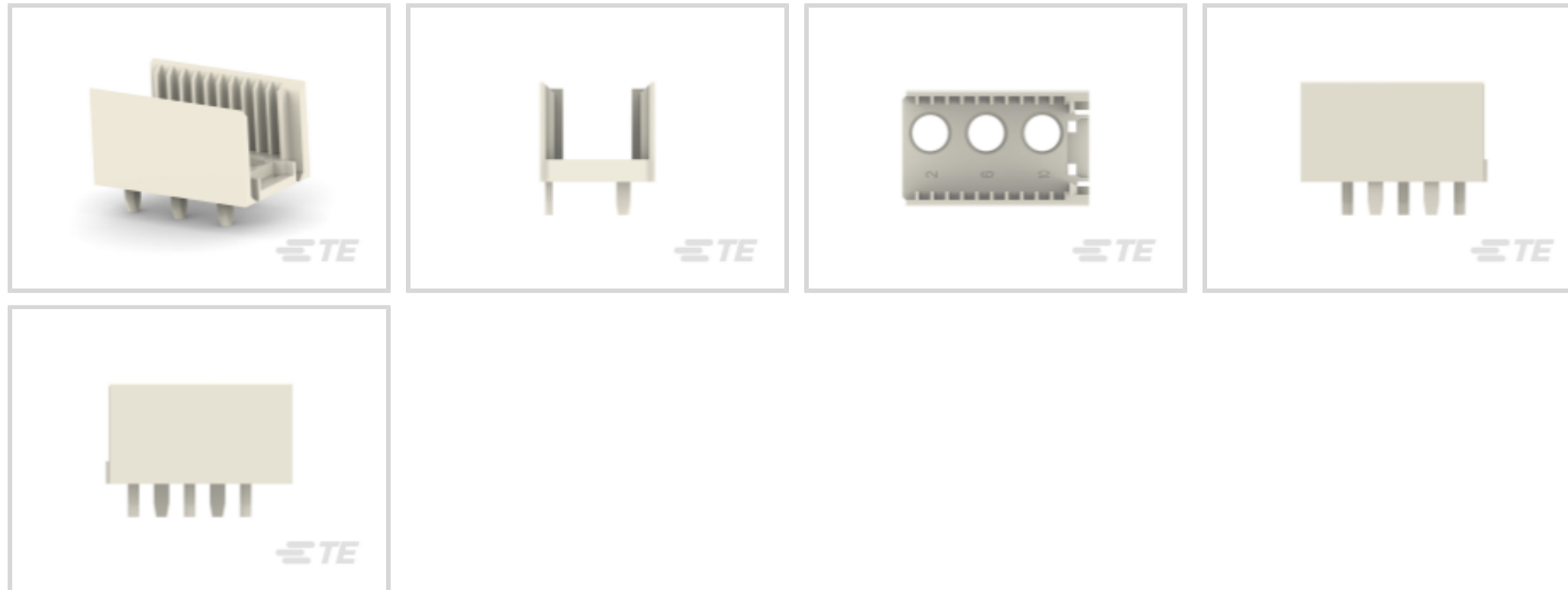

Connector System: **Board-to-Board**

Number of Positions: **3**

Row-to-Row Spacing: **7.5 mm [.295 in]**

Number of Rows: **1**

Number of Columns: **3**

Features

Product Type Features

Connector System	Board-to-Board
Connector & Housing Type	Plug
Sealable	No
Connector & Contact Terminates To	Printed Circuit Board

Configuration Features

PCB Mount Orientation	Vertical
Number of Positions	3
Number of Rows	1
Number of Columns	3

Body Features

Primary Product Color	Gray
-----------------------	------

Mechanical Attachment

Mating Alignment Type	Polarization
Mating Retention	With



Mating Alignment	With
Connector Mounting Type	Board Mount

Housing Features

Housing Material	Glass-Filled Polyester
Centerline (Pitch)	7.5 mm[.295 in]

Dimensions

Connector Length	24.95 mm[.981 in]
Connector Height	13.45 mm[.529 in]
Row-to-Row Spacing	7.5 mm[.295 in]

Usage Conditions

Operating Temperature Range	-55 – 125 °C[-67 – 257 °F]
-----------------------------	----------------------------

Industry Standards

UL Flammability Rating	UL 94V-0
------------------------	----------

Packaging Features

Packaging Method	Tube
------------------	------

Product Compliance

[For compliance documentation, visit the product page on TE.com>](#)

EU RoHS Directive 2011/65/EU	Compliant
EU ELV Directive 2000/53/EC	Compliant
China RoHS 2 Directive MIIT Order No 32, 2016	No Restricted Materials Above Threshold
EU REACH Regulation (EC) No. 1907/2006	Current ECHA Candidate List: JUNE 2024 (241) Candidate List Declared Against: JUNE 2024 (241) Does not contain REACH SVHC
Halogen Content	Not Low Halogen - contains Br or Cl > 900 ppm.
Solder Process Capability	Not applicable for solder process capability

Product Compliance Disclaimer

This information is provided based on reasonable inquiry of our suppliers and represents our current actual knowledge based on the information they provided. This information is subject to change. The part numbers that TE has identified as EU RoHS compliant have a maximum concentration of 0.1% by weight in homogenous materials for lead, hexavalent chromium, mercury, PBB, PBDE, DBP, BBP, DEHP, DIBP, and 0.01% for cadmium, or qualify for an exemption to these limits as defined in the Annexes of Directive 2011/65/EU (RoHS2). Finished electrical and electronic equipment products will be CE marked as required by Directive 2011/65/EU. Components may not be CE marked. Additionally, the part

numbers that TE has identified as EU ELV compliant have a maximum concentration of 0.1% by weight in homogenous materials for lead, hexavalent chromium, and mercury, and 0.01% for cadmium, or qualify for an exemption to these limits as defined in the Annexes of Directive 2000/53/EC (ELV). Regarding the REACH Regulation, the information TE provides on SVHC in articles for this part number is based on the latest European Chemicals Agency (ECHA) 'Guidance on requirements for substances in articles' posted at this URL: <https://echa.europa.eu/guidance-documents/guidance-on-reach>

Also in the Series | Z-PACK 2mm HM

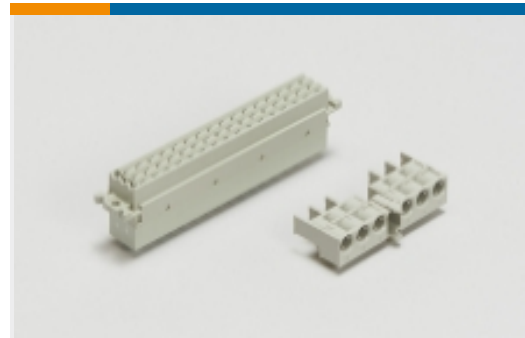

Backplane Connector Housings(4)

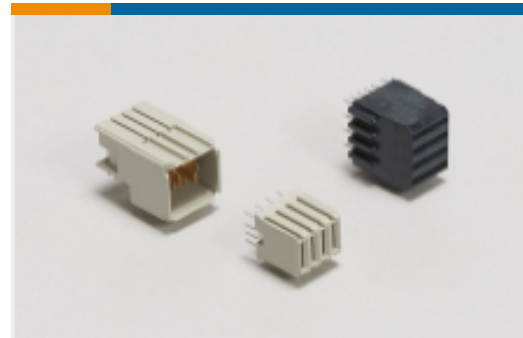

Backplane Power Connectors(6)



Connector Caps & Covers(62)



Connector Contacts(2)



Connector Hardware(97)

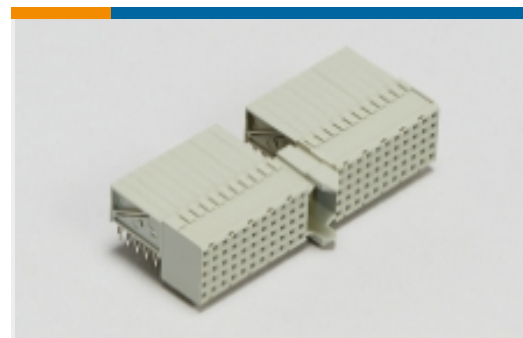

Hard Metric Backplane Connectors (267)

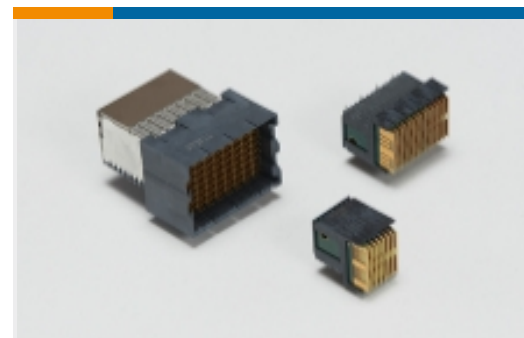

High Speed Backplane Connectors(1)



Insertion & Extraction Tools(2)



Rectangular Power Connectors(87)

Customers Also Bought

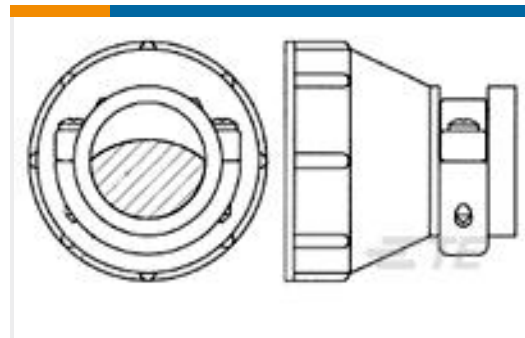

TE Part #208945-5
SZ 14 UNASSM KIT,CMC

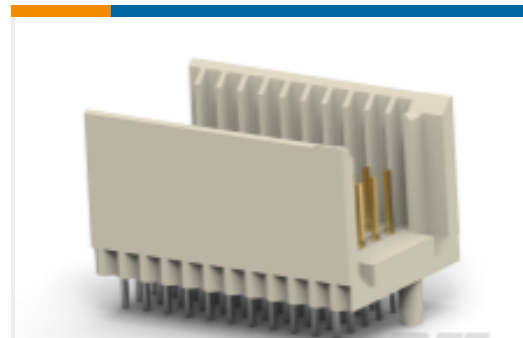

TE Part #5106303-1
Hard Metric Male Connector:
Traditional Backplane, Mezzanine,
2mm



TE Part #66740-6
TYPE XII FEMALE CONT (L.P.)



TE Part #6469025-1
HM-ZD 2PR HDR 40P 2.5MM



TE Part #5223985-1
UPM KEYED GUIDE PIN



TE Part #2329186-1
HM-EZD+, 2PAIRS, 10COLS, VERTICAL,
ASSEMBLY



TE Part #5650978-5
ASSY, PIN, EURO, TYPE C/2, LEAD-FREE,
A&C, 32/



TE Part #7-1879533-4
CRGV0603 1% 576K 400V



TE Part #827551-8
2P MI D-FED KONTGEH

Documents

Product Drawings

Z-PACK/N M-HSG 3P.

English

CAD Files

Customer View Model

[ENG_CVM_CVM_100751-1_A1.3d_stp.zip](#)

English

Customer View Model

[ENG_CVM_CVM_100751-1_A1.2d_dxf.zip](#)

English

Customer View Model

[ENG_CVM_CVM_100751-1_A1.3d_igs.zip](#)

English

3D PDF

3D

By downloading the CAD file I accept and agree to the [Terms and Conditions](#) of use.

Product Specifications

1.5D/2.5D TYPE C COAX CONNECTOR

English

Product Specification

English