

LISA2-W-CLIP

~35° wide beam optimized for CREE XP-E. 6.8 mm high variant with clip installation.

SPECIFICATION:

Dimensions	Ø 9.9 mm
Height	6.8 mm
Fastening	glue, clips
ROHS compliant	yes ⓘ



MATERIALS:

Component	Type	Material	Colour	Finish
LISA2-W	Single lens	PMMA	clear	
LISA2-HLD-CLIP16-XP	Holder	PC	black	

ORDERING INFORMATION:

Component		Qty in box	MOQ	MPQ	Box weight (kg)
FP11076_LISA2-W-CLIP	Single lens	2000	300	100	1.4
» Box size:					

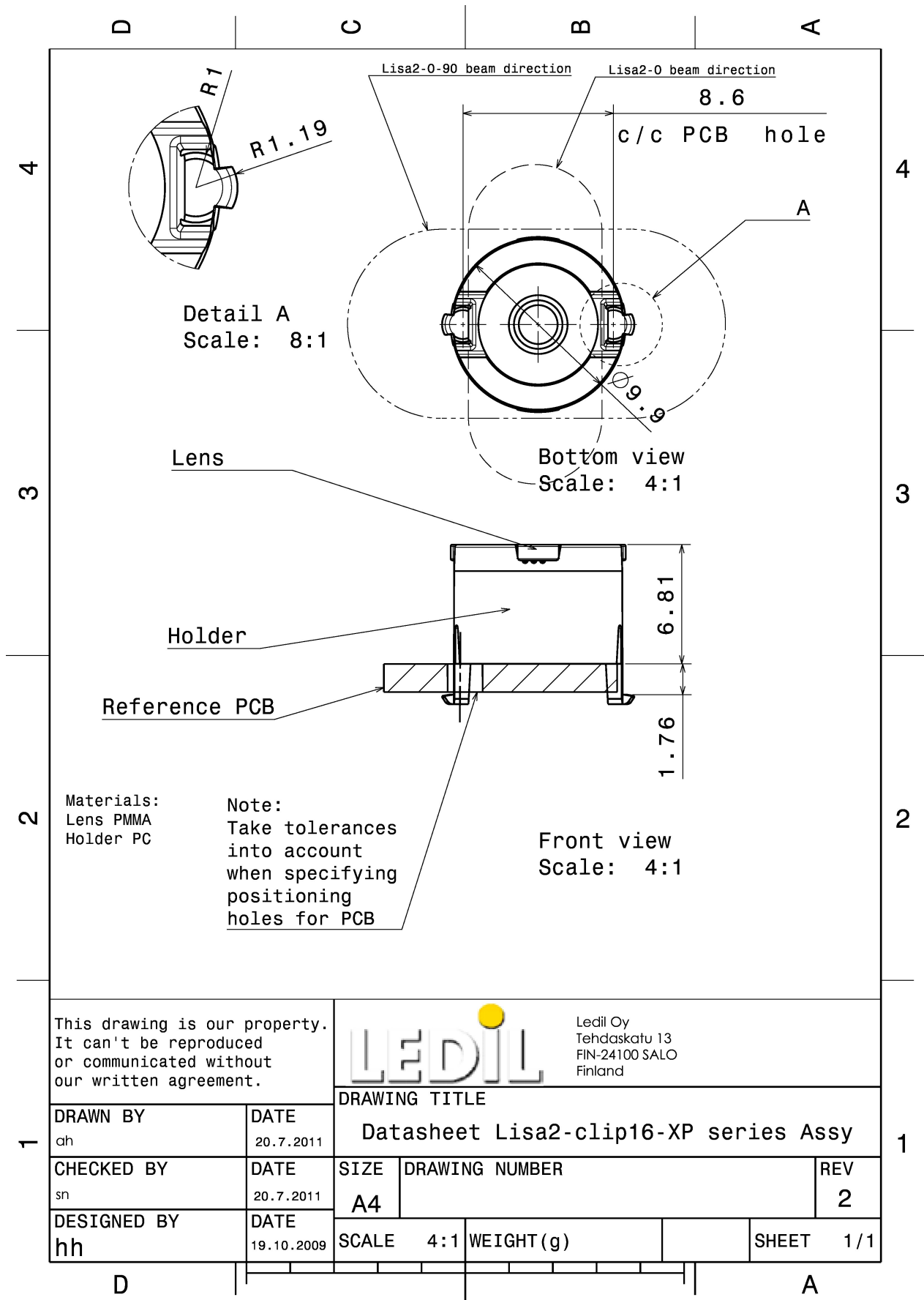

This drawing is our property. It can't be reproduced or communicated without our written agreement.				Ledil Oy Tehdaskatu 13 FIN-24100 SALO Finland	
DRAWN BY ch		DATE 20.7.2011		DRAWING TITLE Datasheet Lisa2-clip16-XP series Assy	
CHECKED BY sn		DATE 20.7.2011		SIZE A4	DRAWING NUMBER
DESIGNED BY hh		DATE 19.10.2009		SCALE 4:1	WEIGHT (g)
				SHEET	1/1

See also our general installation guide: www.ledil.com/installation_guide

OPTICAL RESULTS (MEASURED):



LED XP-E
FWHM / FWTM 37.0°
Efficiency 90 %
Peak intensity 2 cd/lm
LEDs/each optic 1
Light colour White
Required components:

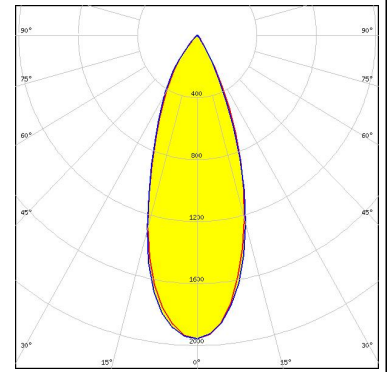

LED XP-G
FWHM / FWTM 48.0°
Efficiency 93 %
LEDs/each optic 1
Light colour White
Required components:



LED LUXEON A
FWHM / FWTM 48.0°
Efficiency 93 %
LEDs/each optic 1
Light colour White
Required components:



LED LUXEON Rebel ES
FWHM / FWTM 46.0°
Efficiency 93 %
LEDs/each optic 1
Light colour White
Required components:

OPTICAL RESULTS (MEASURED):

LUMILEDS

LED LUXEON Z
 FWHM / FWTM 27.0° / 60.0°
 Efficiency 87 %
 Peak intensity 2.9 cd/lm
 LEDs/each optic 1
 Light colour White
 Required components:



LUMILEDS

LED LUXEON Z ES
 FWHM / FWTM 35.0° / 64.0°
 Efficiency 87 %
 Peak intensity 2.1 cd/lm
 LEDs/each optic 1
 Light colour White
 Required components:

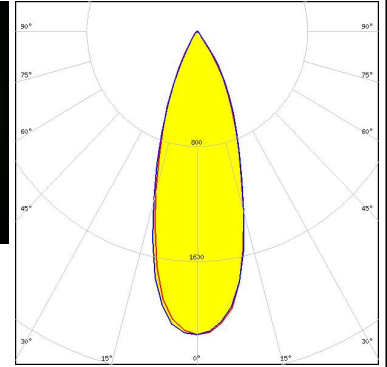
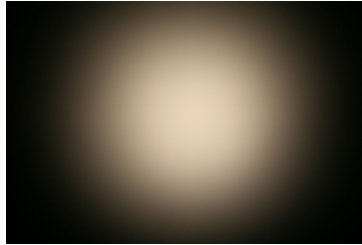

OSRAM

Opto Semiconductors

LED SFH 4170S
 FWHM / FWTM 26.0° / 61.0°
 Efficiency %
 LEDs/each optic 1
 Light colour IR
 Required components:

OSRAM

Opto Semiconductors

LED SFH 4180S
 FWHM / FWTM 26.0° / 61.0°
 Efficiency %
 LEDs/each optic 1
 Light colour IR
 Required components:



OPTICAL RESULTS (MEASURED):

SHARP

LED	Double Dome (GM2BB)
FWHM / FWTM	44.0°
Efficiency	%
LEDs/each optic	1
Light colour	White

Required components:

OPTICAL RESULTS (SIMULATED):

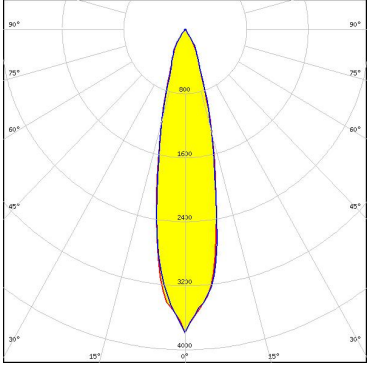
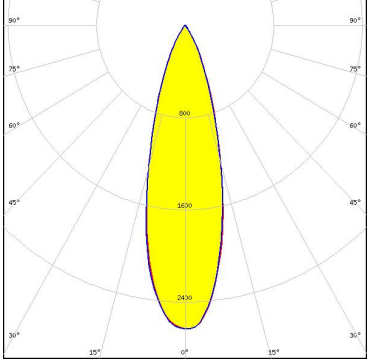
		
LED	XQ-E HD	
FWHM / FWTM	49.0° / 80.0°	
Efficiency	90 %	
Peak intensity	1.3 cd/lm	
LEDs/each optic	1	
Light colour	White	
Required components:		
		
LED	XQ-E HI	
FWHM / FWTM	23.0° / 52.0°	
Efficiency	89 %	
Peak intensity	3.6 cd/lm	
LEDs/each optic	1	
Light colour	White	
Required components:		
		
LED	NCSxE17A	
FWHM / FWTM	30.0° / 57.0°	
Efficiency	84 %	
Peak intensity	2.6 cd/lm	
LEDs/each optic	1	
Light colour	White	
Required components:		
		
		

GENERAL INFORMATION:

NOTE: The typical beam angle will be changed by different color, chip size and chip position tolerance. The typical total beam angle is the full angle measured where the luminous intensity is half of the peak value.

MATERIALS:

As part of our continuous research and improvement processes, and to ensure the best possible quality and availability of our products, LEDiL reserves the right to change material grades without notice.

PRODUCT DATA USER AGREEMENT AND DISCLAIMER:

The measured data in the provided downloadable LEDiL Product Datasheets and Mechanical 2D-Drawings is rounded and provided as reference for planning. LEDiL Oy's optical specifications have been verified by conducting performance testing of the products in accordance with the company's quality system. The reported data are averaged results of multiple measurements with typical variation. LEDiL Oy reserves the right to without prior notification make changes and improvements to its products.

LEDiL Oy assumes neither warranty, nor guarantee nor any other liability of any kind for the contents and correctness of the provided data. The provided data has been generated with highest diligence but the provided data may in reality not represent the complete possible variation range of all intrinsic parameters. Therefore, in certain cases a deviation from the provided data could occur.

LEDiL Oy reserves the right to undertake technical changes of its products without further notification which could lead to changes in the provided data. LEDiL Oy assumes no liability of any kind for the possible deviation from any provided data or any other damage resulting from the usage of the provided data.

The user agrees to this disclaimer and user agreement with the download or usage of the provided files.

LEDiL Oy

Joensuunkatu 13
FI-24240 SALO
Finland

LEDiL Inc.

228 West Page Street
Suite D
Sycamore IL 60178
USA

Ledil Optics Technology (Shenzhen) Co., Ltd.

405 , Block B
Casic Motor Building
Shenzhen 518057
P.R.CHINA

Local sales and technical support

[www.ledil.com/
where_to_buy](http://www.ledil.com/where_to_buy)

Shipping locations

Salo, Finland
Hong Kong, China

Distribution Partners

[www.ledil.com/
where_to_buy](http://www.ledil.com/where_to_buy)