

# TDS:EMIC

## 拓電半導體

自主封測 品質把控 售後保障

WEB | [WWW.TDSEMIC.COM](http://WWW.TDSEMIC.COM)



電源管理



顯示驅動



二三極管



LDO穩壓器



觸摸芯片



MOS管



運算放大器



存儲芯片



MCU



串口通信

MAX232CDR-TD

產品規格說明書

### 5V Dual channel RS-232 Drivers/Receivers

#### FEATURES

- Output voltage levels are compatible with input levels of CMOS and TTL integrated circuits
- Meets All EIA/TIA-232E and V.28/V.24 Specifications
- Supply voltage range from 5.5V
- Low input current: 1.0 $\mu$ A at 25°C
- Output current 30mA
- Available in SOP-16 Package

#### APPLICATIONS

- Portable Computers
- Battery-Powered RS-232 Systems
- Interface Translation
- Low-Power Modems
- Terminals

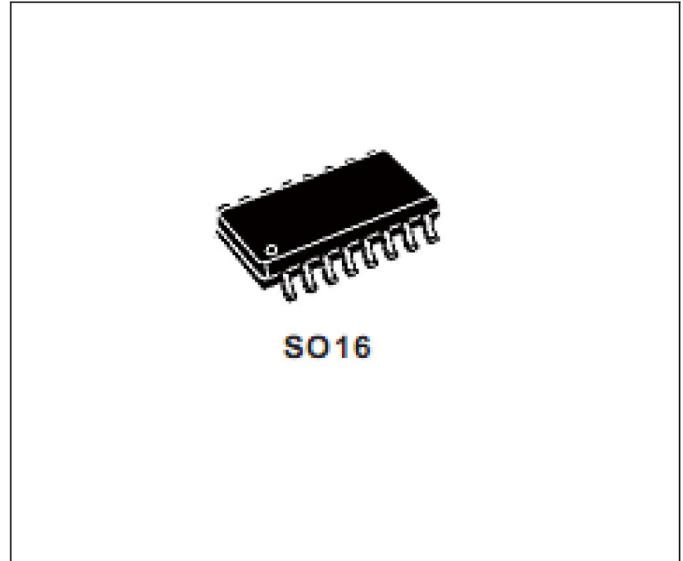

#### ORDERING INFORMATION

Device	Package
MAX232CDR	SOP-16

\* Refer to the ordering information for the details.

#### DESCRIPTION

The MAX232CDR

is a dual driver/receiver of RS-232 standard with a single supply voltage and bipolar output voltage of the transmitter formed by a built-in voltage multiplying generator on four 1.0 $\mu$ F external capacitors, designed for use in state-of-the-art high performance computing systems, high-speed electronic devices with high reliability of information exchange between remote objects.

Input voltage levels are compatible with standard CMOS and TTL levels.

#### ABSOLUTE MAXIMUM RATINGS

PARAMETER	SYMBOL	MIN.	MAX.	UNIT
Supply Voltage	$V_{CC}$	-0.3	6.0	V
Transmitter High Output Voltage	$V_+$	$V_{CC}-0.3$	9.8	V
Transmitter Low Output Voltage	$V_-$	-9.0	0.3	V
Transmitter Input Voltage	$V_{TIN}$	-0.3	$V_++0.3$	V
Receiver Input Voltage	$V_{RIN}$	-20	20	V
Voltage Applied to Transmitter Output	$V_{TOUT}$	$V_- - 0.3$	$V_+ + 0.3$	V
Voltage Applied to Receiver Output	$V_{ROUT}$	-0.3	$V_{CC} + 0.3$	V
Storage Temperature Range	$T_{STG}$	-65	150	°C

### 5V Dual channel RS-232 Drivers/Receivers

#### RECOMMENDED OPERATING CONDITIONS

PARAMETER	SYMBOL	MIN.	MAX.	UNIT
Supply Voltage	$V_{CC}$	4.5	5.5	V
Transmitter Input Voltage	$V_{TIN}$	0	$V_{CC}$	V
Receiver Input Voltage	$V_{RIN}$	-20	20	V
Output Current of Transmitter Short Circuit	$I_{SC}$	-	$\pm 60$	mA
Ambient Temperature Range	$T_A$	-40	+85	$^{\circ}C$

#### ORDERING INFORMATION

Package	Oder No.	Package Marking	Compliance	Supplied As
SOP -16	MAX232CDR	MAX232CDR	RoHS, Green	Tube

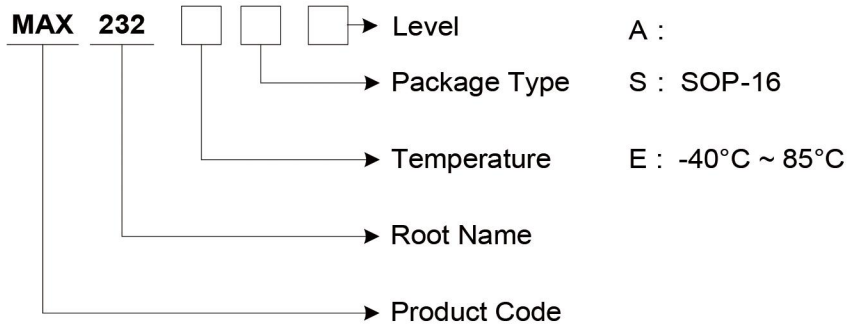

### 5V Dual channel RS-232 Drivers/Receivers

#### PIN CONFIGURATION

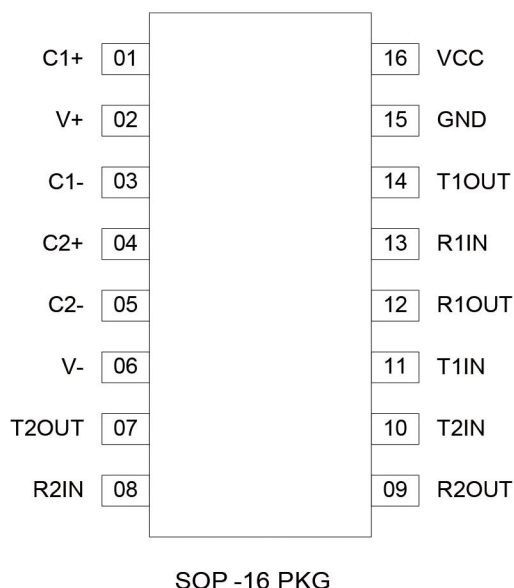

#### PIN DESCRIPTION

Pin No.	Pin Name	Pin Description
1	C1+	Terminal for Positive Charge-Pump C1 Capacitor
2	V+	Positive Voltage Generated by the Charge-Pump
3	C1-	Terminal for Negative Charge-Pump C1 Capacitor
4	C2+	Terminal for Positive Charge-Pump C2 Capacitor
5	C2-	Terminal for Negative Charge-Pump C2 Capacitor
6	V-	Negative Voltage Generated by the Charge-Pump
7	T2OUT	RS-232 Driver Output (Levels RS-232)
8	R2IN	RS-232 Receiver Input (Levels RS-232)
9	R2OUT	RS-232 Receiver Output (Levels TTL/CMOS)
10	T2IN	RS-232 Driver Input (Levels TTL/CMOS)
11	T1IN	RS-232 Driver Input (Levels TTL/CMOS)
12	R1OUT	RS-232 Receiver Output (Levels TTL/CMOS)
13	R1IN	RS-232 Receiver Input (Levels RS-232)
14	T1OUT	RS-232 Driver Output (Levels RS-232)
15	GND	Ground
16	VCC	Supply Voltage Input

### 5V Dual channel RS-232 Drivers/Receivers

#### TYPICAL APPLICATION CIRCUIT

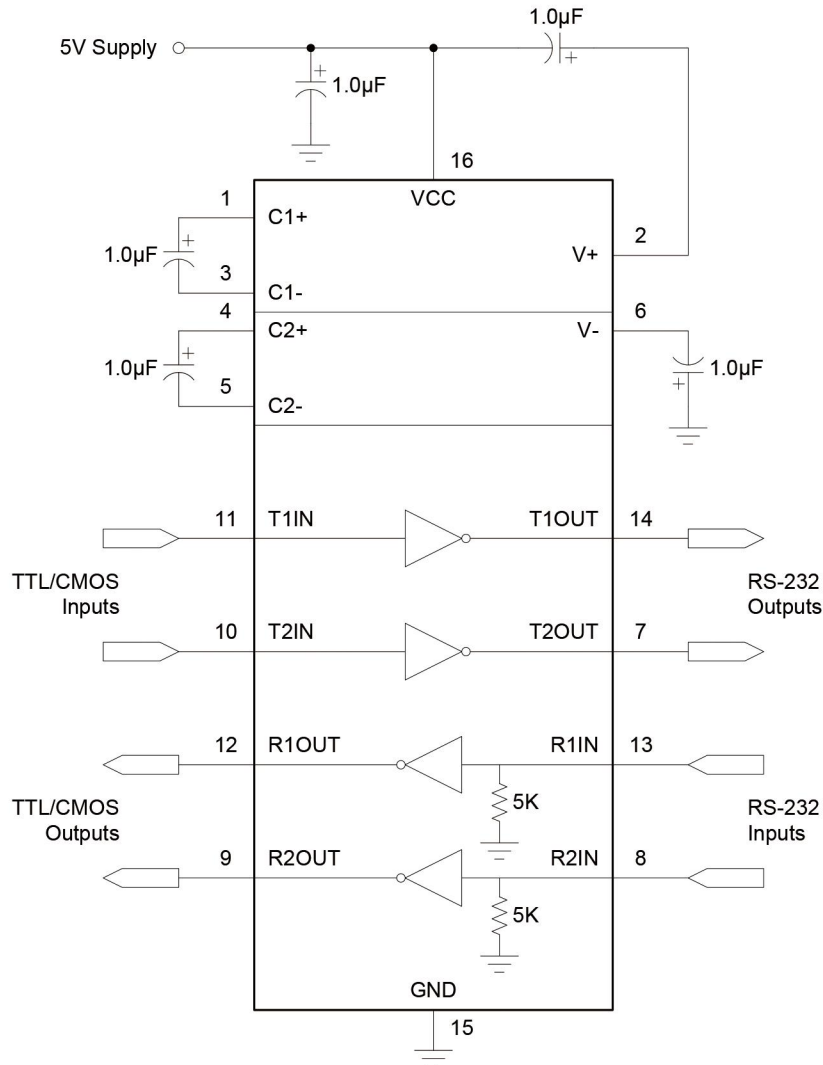

#### FUNCTION TABLE

INPUT (RIN, TIN)	OUTPUT (ROUT, TOUT)
L (Low Level)	H (High Level)
H (High Level)	L (Low Level)

### 5V Dual channel RS-232 Drivers/Receivers

#### ELECTRICAL CHARACTERISTICS

(Limits in standard typeface are for  $T_A=25^\circ\text{C}$ , and the limits in boldface type apply over full operating temperature range.)

PARAMETER	SYMBOL	TEST CONDITIONS	MIN.	TYP.	MAX.	UNIT	
Supply Current	$I_{CC}$	$V_{CC} = 5.5\text{V}$ $V_{IL} = 0\text{V}$	-	-	10.0 <b>14.0</b>	mA	
<b>Receiver Parameters</b>							
Hysteresis Voltage	$V_h$	$V_{CC} = 5.0\text{V}$	0.2 <b>0.2</b>	-	0.9 <b>1.0</b>	V	
On (Operation) Voltage	$V_{on}$	$V_O \leq 0.1\text{V}$ , $I_{OL} \leq 20\mu\text{A}$	-	-	2.4 <b>2.3</b>	V	
Off (Dropout) Voltage	$V_{off}$	$V_O \geq V_{CC} - 0.1\text{V}$ $I_{OH} \leq -20\mu\text{A}$	0.8 <b>0.9</b>	-	-	V	
Output Low Voltage	$V_{OL}$	$I_L = 3.2\text{mA}$ , $V_{CC} = 4.5\text{V}$ , $V_{IH} = 2.4\text{V}$	-	-	0.3 <b>0.4</b>	V	
Output High Voltage	$V_{OH}$	$I_{OH} = -1.0\text{mA}$ , $V_{CC} = 4.5\text{V}$ , $V_{IL} = 0.8\text{V}$	3.6 <b>3.5</b>	-	-	V	
Input Resistance	$R_i$	$V_{CC} = 5.0\text{V}$	3.0 <b>3.0</b>	-	7.0 <b>7.0</b>	k $\Omega$	
<b>Transmitter Parameters</b>							
Output Low Voltage	$V_{OL}$	$V_{CC} = 4.5\text{V}$ , $V_{IH} = 2.0\text{V}$ , $R_L = 3.0\text{k}\Omega$	-	-	-5.2 <b>-5.0</b>	V	
Output High Voltage	$V_{OH}$	$V_{CC} = 4.5\text{V}$ , $V_{IL} = 0.8\text{V}$ , $R_L = 3.0\text{k}\Omega$	5.2 <b>5.0</b>	-	-	V	
Input Low Current	$I_{IL}$	$V_{CC} = 5.5\text{V}$ , $V_{IL} = 0\text{V}$	-	-	-1.0 <b>-10.0</b>	$\mu\text{A}$	
Input High Current	$I_{IH}$	$V_{CC} = 5.5\text{V}$ , $V_{IH} = V_{CC}$	-	-	1.0 <b>10.0</b>	$\mu\text{A}$	
Speed Of Output Front Charge	SR	$V_{CC} = 5.0\text{V}$ , $C_L = 50 - 1000\text{pF}$ , $R_L = 3.0 - 7.0\text{k}\Omega$	3.0 <b>2.7</b>	-	30 <b>27</b>	V/ $\mu\text{s}$	
Output Resistance	$R_O$	$V_{CC} = V^+ = V^- = 0\text{V}$ $V_O = \pm 2\text{V}$	350 <b>300</b>	-	-	$\Omega$	
Short Circuit Output Current	$I_{SC}$	$V_{CC} = 5.5\text{V}$ $V_O = 0\text{V}$	$V_I = V_{CC}$	-	-	-50 <b>-60</b>	mA
			$V_I = 0$	-	-	50 <b>60</b>	
Speed Of Information Transmission	ST	$V_{CC} = 4.5\text{V}$ , $C_L = 1000\text{pF}$ , $R_L = 3.0\text{k}\Omega$ , $t_w = 7\mu\text{s}$ (for extreme, $t_w = 8\mu\text{s}$ )	140 <b>120</b>	-	-	kbit/s	
<b>Dynamic Parameters</b>							
Signal Propagation Delay Time When Switching On (Off)	$t_{PHLR}$ ( $t_{PLHR}$ )	$V_{CC} = 4.5\text{V}$ , $C_L = 150\text{pF}$ , $V_{IL} = 0\text{V}$ , $V_{IH} = 3.0\text{V}$ , $t_{LH} = t_{HL} \leq 10\text{ns}$	-	-	9.7 <b>10.0</b>	$\mu\text{s}$	
Signal Propagation Delay Time When Switching On (Off)	$t_{PHLT}$ ( $t_{PLHT}$ )	$V_{CC} = 4.5\text{V}$ , $C_L = 2500\text{pF}$ , $V_{IL} = 0\text{V}$ , $V_{IH} = 3.0\text{V}$ , $R_L = 3\text{k}\Omega$ , $t_{LH} = t_{HL} \leq 10\text{ns}$	-	-	5.0 <b>6.0</b>	$\mu\text{s}$	

### 5V Dual channel RS-232 Drivers/Receivers

#### TIMING DIAGRAM

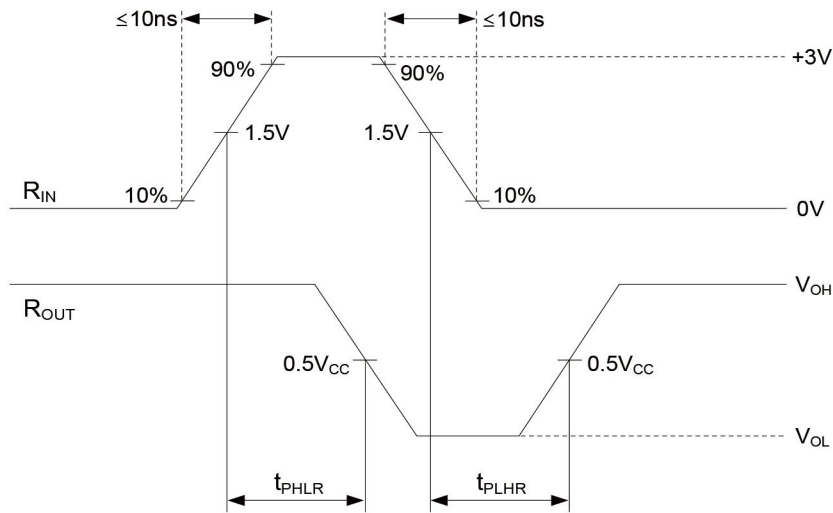

Figure 1.  $t_{PHL}$  and  $t_{PLH}$  waveforms of Receiver

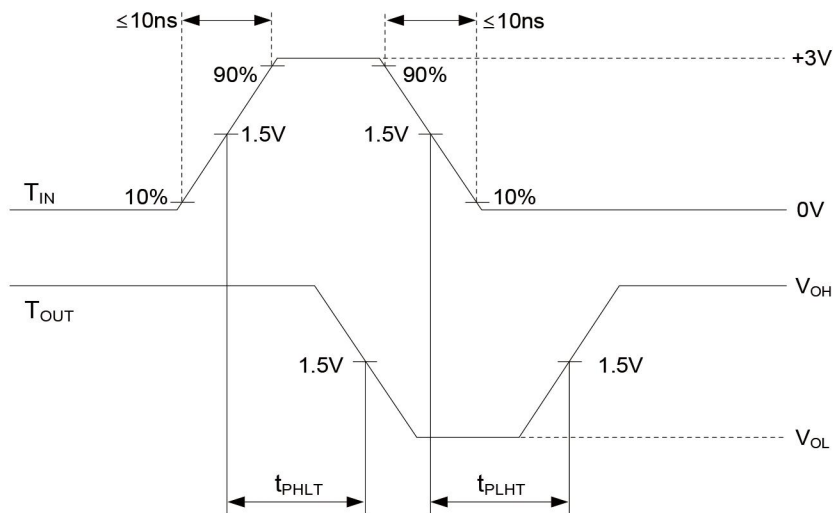

Figure 2.  $t_{PHL}$  and  $t_{PLH}$  waveforms of Transmitter

### 5V Dual channel RS-232 Drivers/Receivers

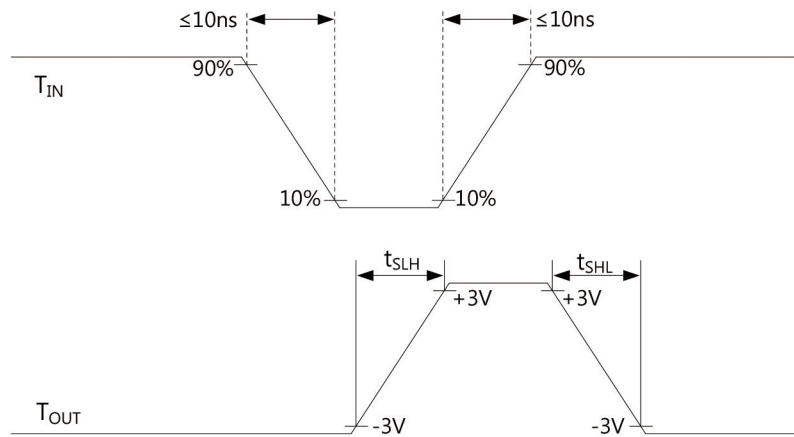

Figure 3.  $t_{SLH}$  and  $t_{SHL}$  waveforms of Transmitter

### 5V Dual channel RS-232 Drivers/Receivers

---

#### REVISION NOTICE

The description in this datasheet is subject to change without any notice to describe its electrical characteristics properly.