

RoHs

VER	MARK	PR. BY	DESCRIPTION	DATE

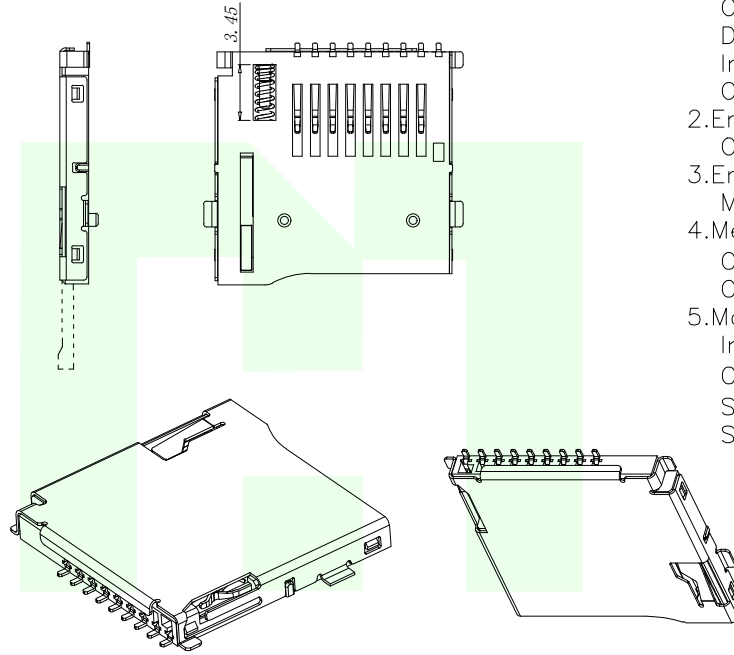
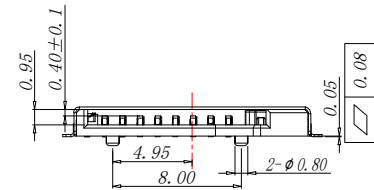
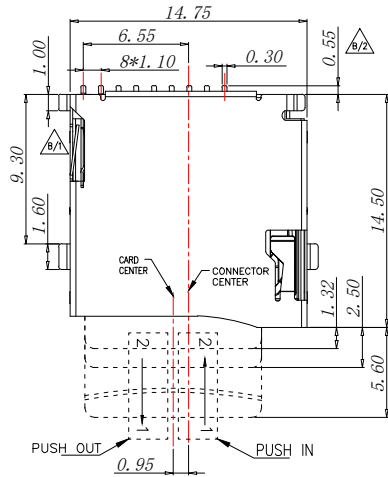
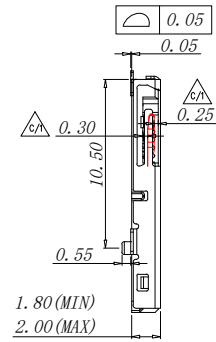

Specification:

- Electrical Characteristics:
 - Contact Current Rating: 0.5 Amperes.
 - Dielectric Withstanding Voltage: AC500V r.m.s.
 - Insulation Resistance: 1000 MΩ Minimum.
 - Contact Resistance: 40 mΩ Maximum.
- Environmental:
 - Operating Temperature: -25°C ~ +90°C.
- Environmental:
 - Mating Cycles: 5,000 Insertions.
- Mechanical Characteristics:
 - Card Push Insertion/Out Force: 0.2~1.40kgf.
 - Contact Separation Force: 0.20kgf Minimum.
- Material:
 - Insulator: HI-Temp Plastic UL 94V-0 Rated.
 - Contact: Copper Alloy (t=0.15mm).
 - Shell: Stainless Steel (t=0.15mm).
 - Spring: SWP.

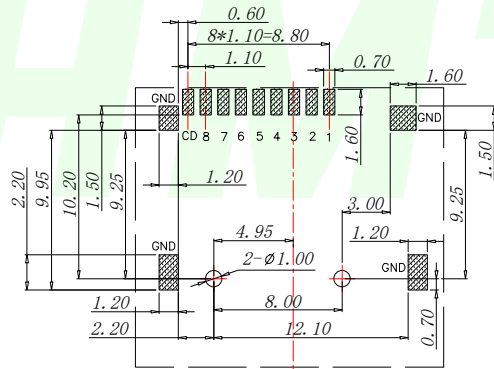
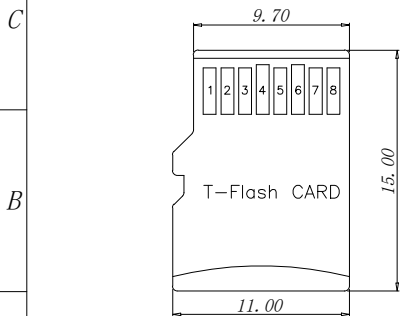

▨ PAD AREA
 ■ KEEP OUT AREA

RECOMMENDED PCB LAYOUT
 GENERAL TOLERANCE ±0.05

Circuit Diagram for Detect Switch

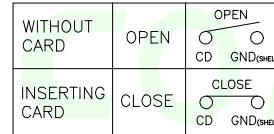

TF CARD PIN DEFINE			
PIN NO.	NAME	YTYPE	DESCRIPTION
1	DAT2	I/O/PP	DATE LINE(BIT2)
2	CD/DAT3	I/O/PP	CARD DETECT DATE LIN(BIT3)
3	CMD	PP	COMMAND RESPONSE
4	VDD	S	SUPPLY VOLTAGE
5	CLX	I	CLOCK
6	VSS	S	SUPPLY VOLTAGE GROUND
7	DATO	I/O/PP	DATE LINE(BIT0)
8	DAT1	I/O/PP	DATE LINE(DIT1)

GENERAL TOLERANCES UNLESS SPECIFIED		深圳市华明通电子有限公司 Shenzhen Huamingtong Electronics Co., Ltd	
.X ±0.35	.X° ±3°	PART NO. HMT-MR01A-01211	TITLE: MICRO SD CARD PUSH PUSH SMT 镀金 外牌
.XX ±0.25	.XX° ±2°	DESIGN: James	CUSTOMER
.XXX ±0.15		CHED: Talen	SIZE: A4
MANUFACTURE DWG		APPD: Sophia	UNITS: MM
			SCALE: N:A
			SHEET: 1/1

RoHs

VER	MARK	PR. BY	DESCRIPTION	DATE

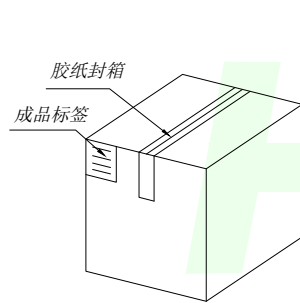
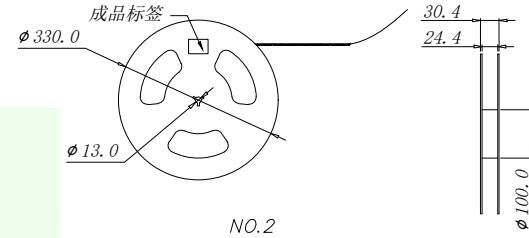
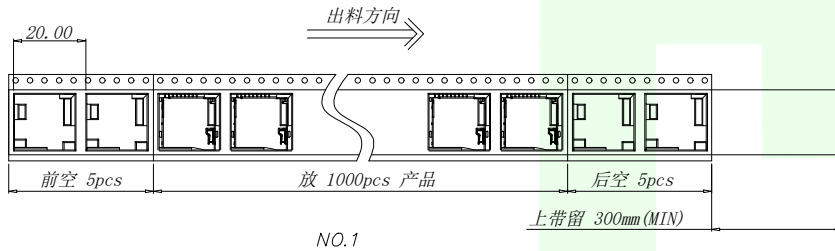
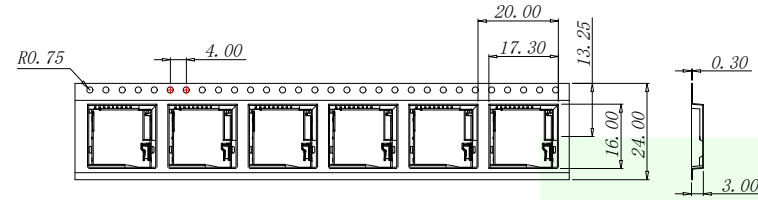

纸箱规格 : 340*340*385

NO.4

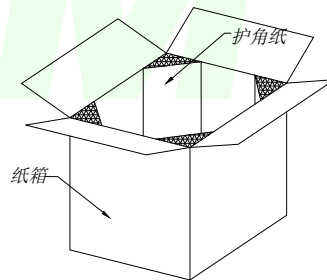
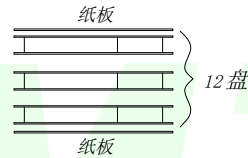

NO.3

1. 材质要求:

- 1.1 纸箱的材质为K=K;外形尺寸为34*34*38.5;
- 1.2 卷盘的材质为PS,卷盘的外形尺寸为 $\phi 330*30.4$;
- 1.3 卷带的材质为PS,卷带的外形尺寸为20200*24.00*3.0mm;

2. 包装方式:

- 2.1 将卷带放入包装机后,前空5PCS,后放产品1000PCS,再后空5PCS;上带留300MM长度。
- 2.2 将包装好的产品从包装机上取下并包装好,贴上内盘标签;
- 2.3 把累叠好的12盘叠放入纸箱中共计12Kset,上下放纸板,纸箱四个角塞护角纸;
- 2.4 把包装好的成品打包封箱,并在纸箱外贴上标签

GENERAL TOLERANCES UNLESS SPECIFIED		 深圳市华明通电子有限公司 Shenzhen Huamingtong Electronics Co., Ltd			
.X ±0.35	.X° ±3°	PART NO. HMT-MR01A-01211	TITLE: MICRO SD CARD PUSH PUSH SMT 镀金 外牌		
.XX ±0.25	.XX° ±2°	DESIGN: James	CUSTOMER	SIZE A4	
.XXX ±0.15		CHED: Talen		UNITS MM	
MANUFACTURE DWG		APPD: Sophia		SCALE N:A	SHEET 1/1