

Product Summary

- V_{DS} 100V
- I_D 80A
- $R_{DS(ON)}$ (at $V_{GS}=10V$) < 12m Ω
- 100% EAS Tested
- 100% ∇V_{DS} Tested

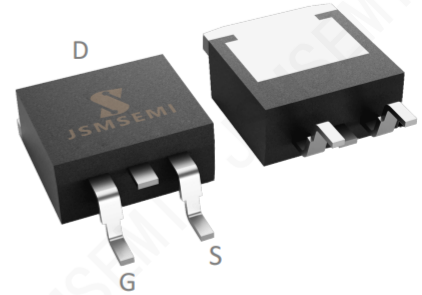

General Description

- Trench Power MOSFET technology
- Excellent package for heat dissipation
- High density cell design for low $R_{DS(ON)}$
- Moisture Sensitivity Level 1
- Epoxy Meets UL 94 V-0 Flammability Rating
- Halogen Free

Applications

- Power switching application
- Uninterruptible power supply
- DC-DC convertor
- Motor drivers

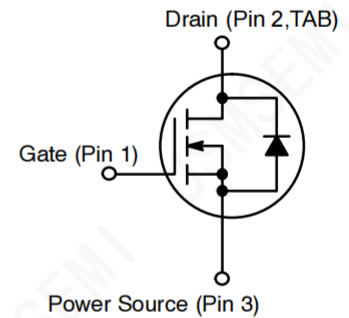

Absolute Maximum Ratings ($T_A=25^\circ\text{C}$, unless otherwise specified)

Parameter	Symbol	Rating	Unit	
Drain-Source Voltage	V_{DS}	100	V	
Gate-Source Voltage	V_{GS}	± 20	V	
Continuous Drain Current	I_D	$T_C=25^\circ\text{C}$ ^{Note1}	80	A
		$T_C=100^\circ\text{C}$	60	A
		$T_A=25^\circ\text{C}$ ^{Note4}	17	A
Pulsed Drain Current ^{Note2}	$I_{D,pulse}$	600	A	
Avalanche energy, single pulse ^{Note3}	EAS	110	mJ	
Power Dissipation	P_D	$T_C=25^\circ\text{C}$	256	W
		$T_A=25^\circ\text{C}$ ^{Note4}	3.1	W
Operating and Storage Temperature Range	T_J, T_{SGT}	-55 to 150	$^\circ\text{C}$	

Thermal Resistance

Parameter	Symbol	Min	Typ	Max	Unit
Thermal Resistance, Junction-to-Case	$R_{\theta JC}$	-	-	0.8	$^\circ\text{C/W}$
Thermal Resistance, Junction-to-Ambient ^{Note4}	$R_{\theta JA}$	-	-	40	$^\circ\text{C/W}$

Ordering Information

Order number	Package	Marking	Operation Temperature Range	MSL Grade	Ship, Quantity	Green
IRFS4610TRLPBF-JSM	TO-263	FS4610	-55 to 150 $^\circ\text{C}$	1	T&R, 800	Rohs

Electrical Characteristics ($T_J=25^{\circ}\text{C}$, unless otherwise specified)

Parameter	Symbol	Test Conditions	Min	Typ	Max	Unit
Statistic Characteristics						
Drain-Source Breakdown Voltage	B_{VDSS}	$V_{GS}=0V, I_D=250\mu A$	100	-	-	V
Gate-Body Leakage Current	I_{GSS}	$V_{GS}=\pm 20V, V_{DS}=0V$	-	-	± 100	nA
ZeroGate Voltage Drain Current	I_{DSS}	$V_{DS}=100V, V_{GS}=0V$	-	-	1	μA
Gate Threshold Voltage	$V_{GS(th)}$	$V_{DS}=V_{GS}, I_D=250\mu A$	2.2	3.0	3.8	V
Static Drain-Source On-Resistance	$R_{DS(ON)}$	$V_{GS}=10V, I_D=50A$	-	10.0	12.0	m Ω
Gate Resistance	R_g	$f=1\text{MHz}$	-	1.5	-	Ω
Forward Transconductance ^{Note5}	g_{fs}	$V_{DS}=5V, I_D=50A$	-	90	-	S
Dynamic Characteristics^{Note5}						
Input Capacitance	C_{iss}	$V_{GS}=0V, V_{DS}=50V, f=1\text{MHz}$	-	4646	-	pF
Output Capacitance	C_{oss}		-	580	-	pF
Reverse Transfer Capacitance	C_{rss}		-	30	-	pF
Turn-on Delay Time	$t_{d(on)}$	$V_{DS}=50V, I_D=50A$ $V_{GS}=10V, R_G=6\Omega$	-	53	-	ns
Rise Time	t_r		-	88	-	ns
Turn-off Delay Time	$t_{d(off)}$		-	85	-	ns
Fall Time	t_f		-	22	-	ns
Gate Charge Characteristics						
Total Gate Charge	Q_g	$V_{DS}=50V, V_{GS}=10V$ $I_D=50A$	-	69	-	nC
Gate to Source Charge	Q_{gs}		-	22	-	nC
Gate to Drain Charge	Q_{gd}		-	17	-	nC
Reverse Diode Characteristics^{Note5}						
Drain-Source Diode Forward Voltage	V_{SD}	$V_{GS}=0V, I_F=50A$	-	0.92	1.2	V
Reverse recovery time	t_{rr}	$I_F=50A, V_{DS}=50V$ $di/dt=100A/\mu s$	-	72	-	ns
Reverse recovery charge	Q_{rr}		-	138	-	nC

Notes:

1. Package limited
2. Pulse width limited by maximum junction temperature
3. $V_{DS}=50V, V_{GS}=10V, L=0.1\text{mH}$
4. $R_{\theta JA}$ is determined with the device mounted on a 1 in² pad 2 oz copper pad on a 1.5x1.5 in. board of FR-4 material
5. Guaranteed by design, not subject to production testing

Electrical Characteristics Diagrams

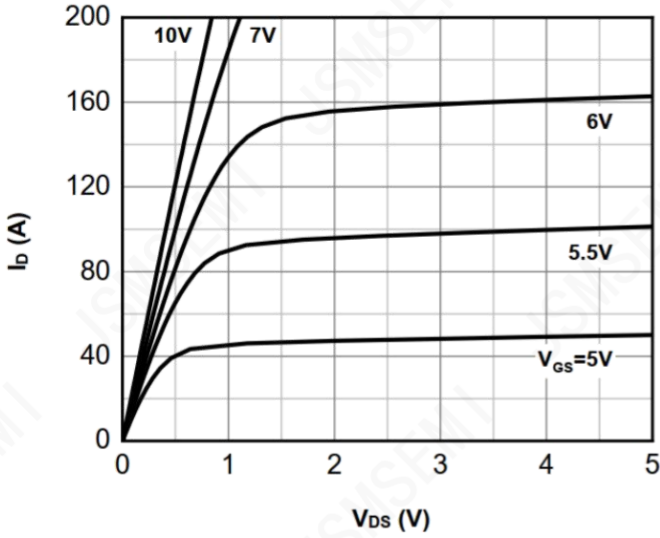

Figure 1: Typ. Output Characteristics

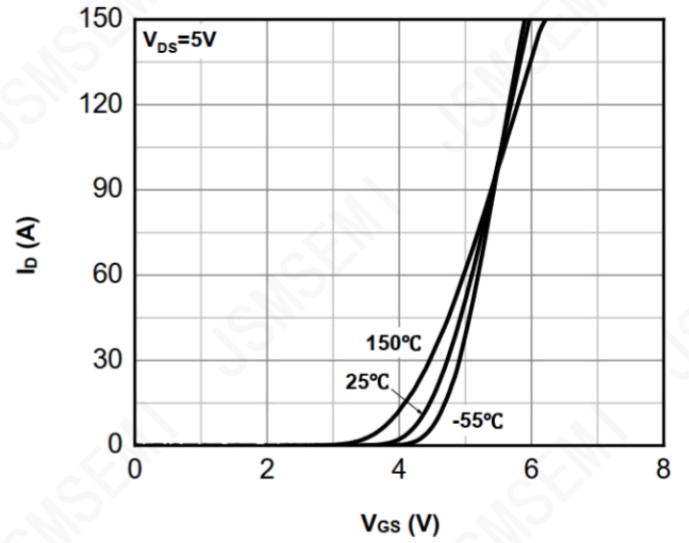

Figure 2: Typ. Transfer Characteristics

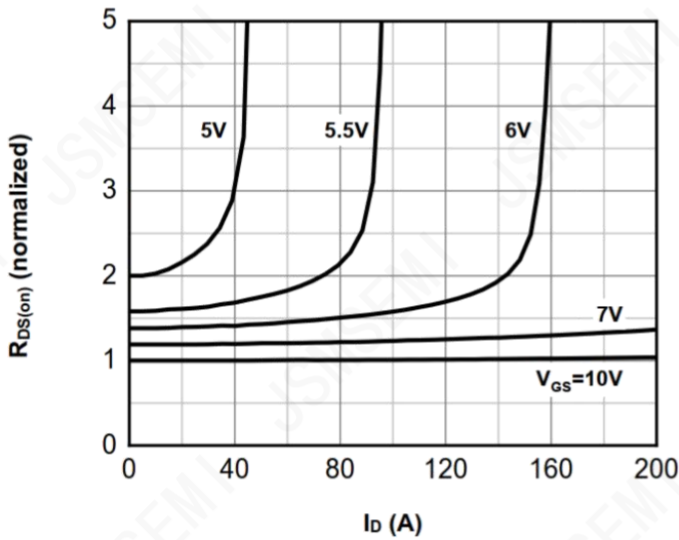

Figure 3: Normalized On-Resistance vs. Drain Current

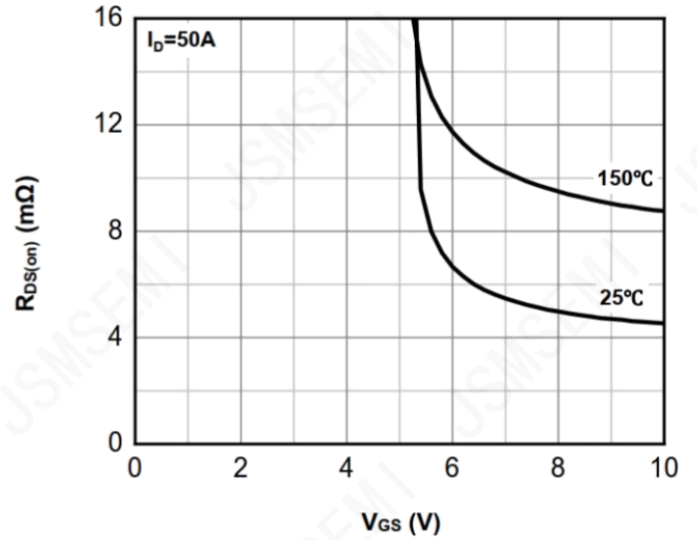

Figure 4: Typ. On-Resistance vs. Gate-source Voltage

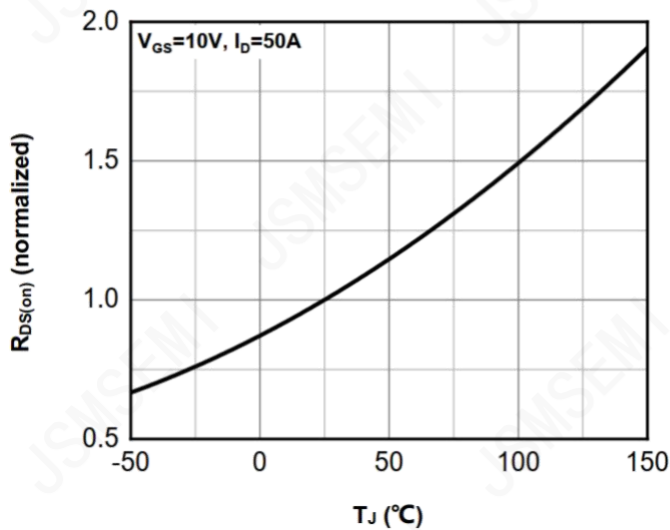

Figure 5: Normalized On-Resistance vs. Junction Temperature

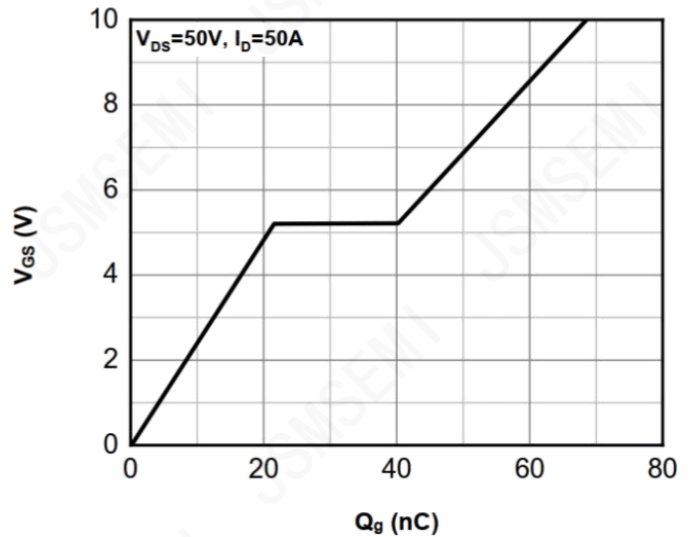

Figure 6: Typ. Gate Charge

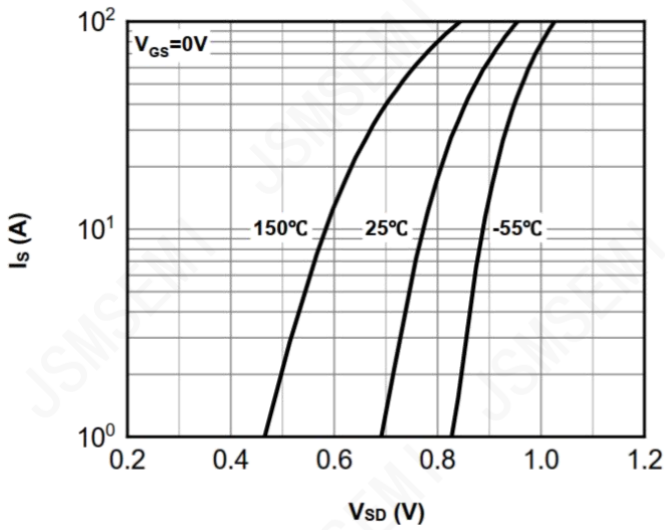

Figure 7: Typ. Forward Characteristics of Body Diode

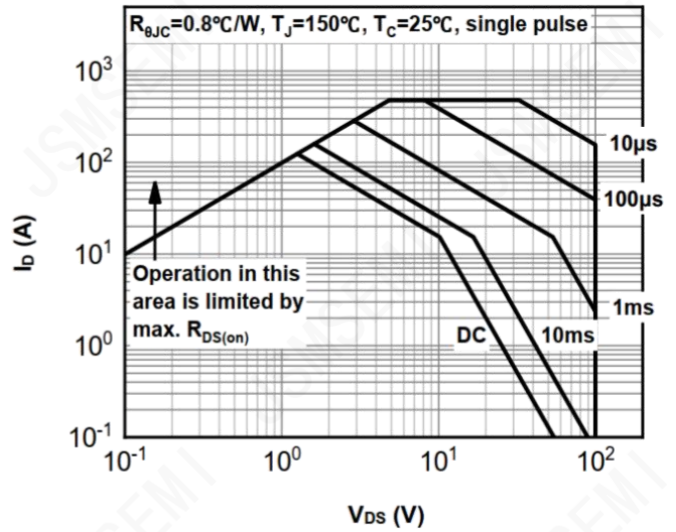

Figure 8: Safe Operating Area

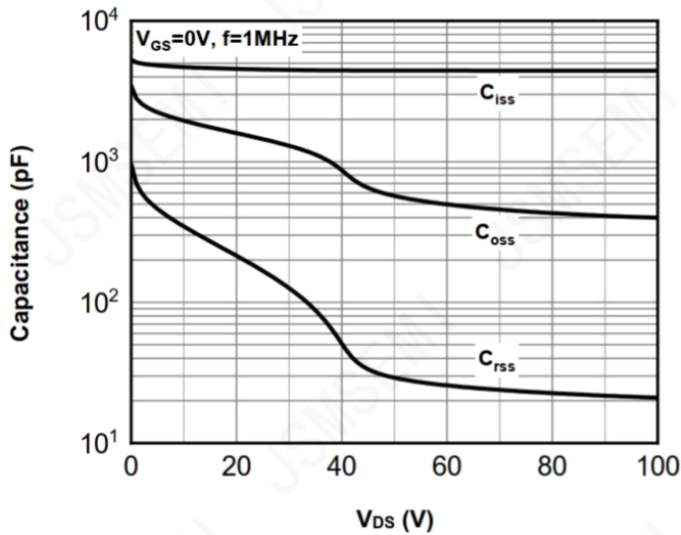

Figure 9: Typ. Capacitances

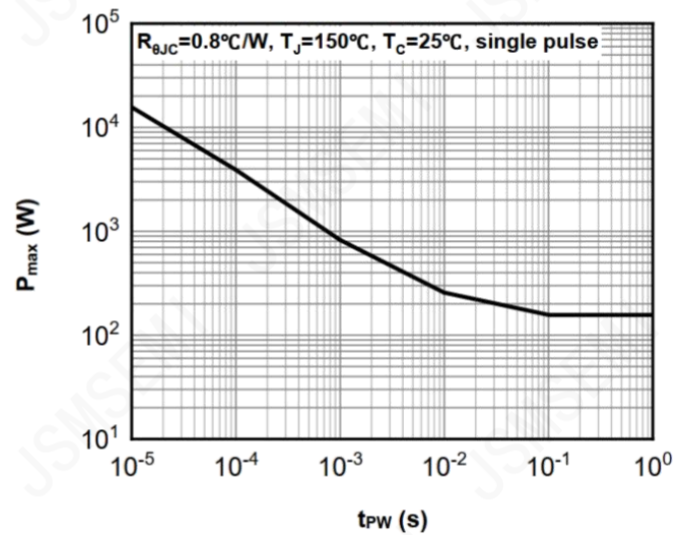

Figure 10: Single Pulse Maximum Power Dissipation

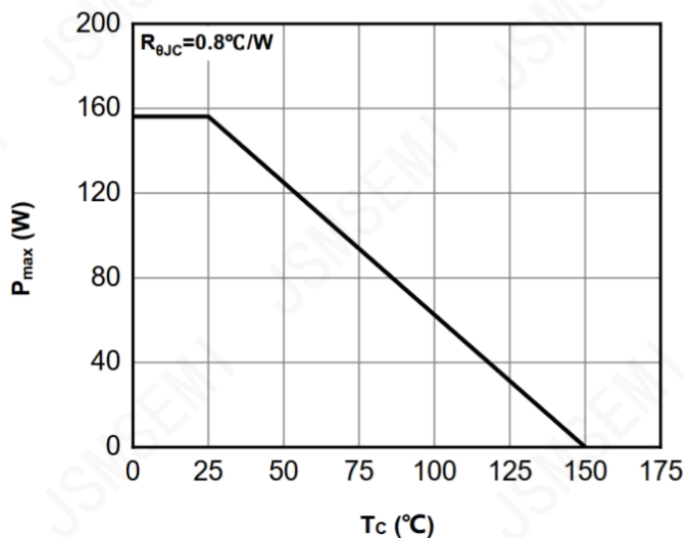

Figure 11: Max. Power Dissipation vs. Case Temperature

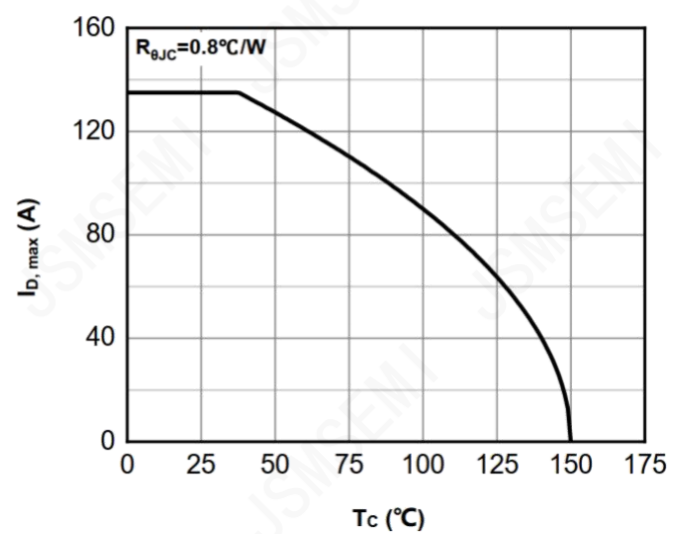

Figure 12: Max. Continuous Drain Current vs. Case Temperature

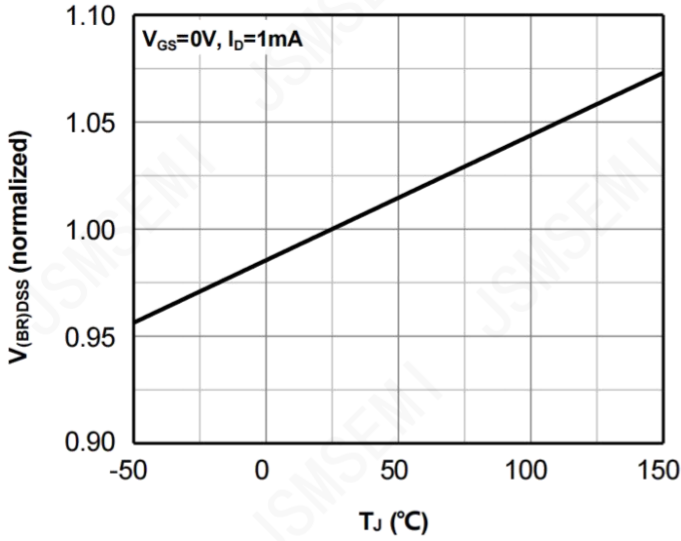

Figure 13: Normalized $V_{(BR)DSS}$ vs. Junction Temperature

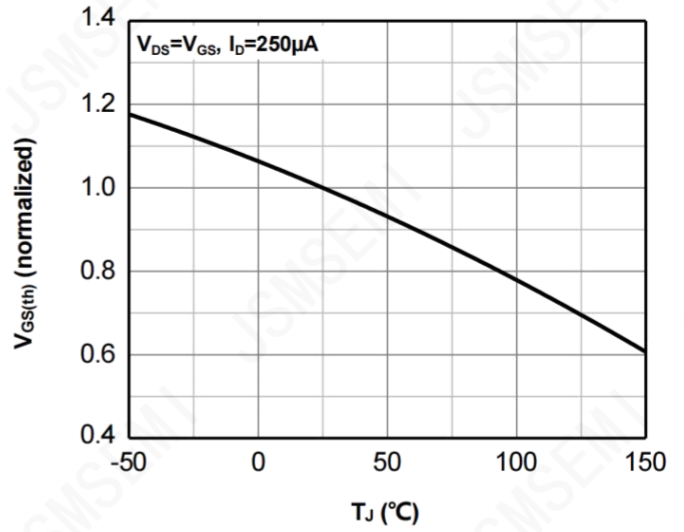

Figure 14: Normalized $V_{GS(th)}$ vs. Junction Temperature

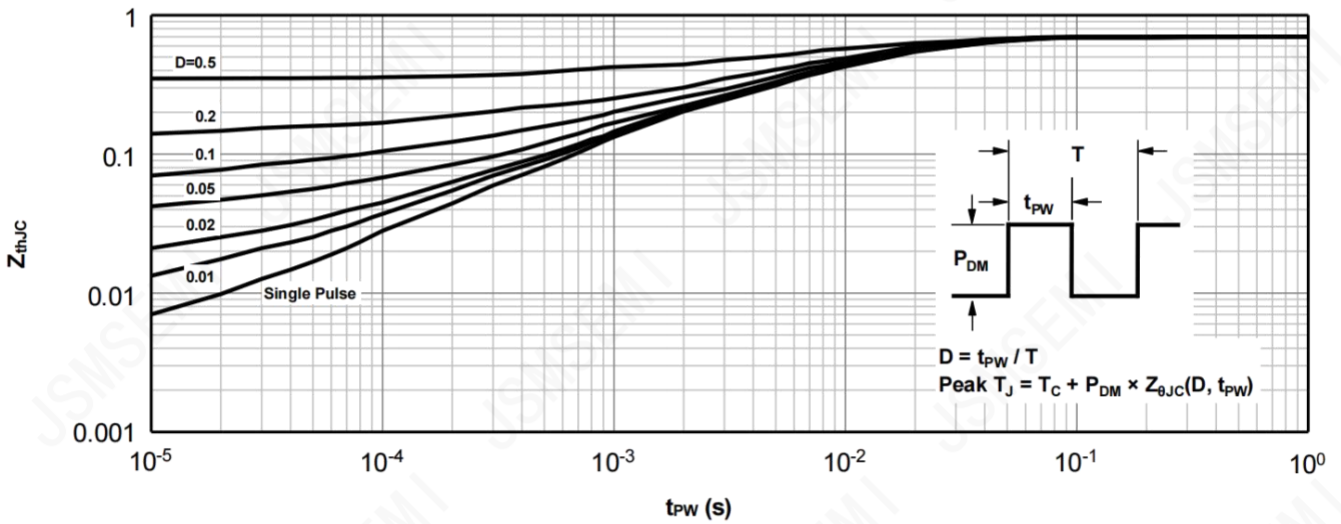
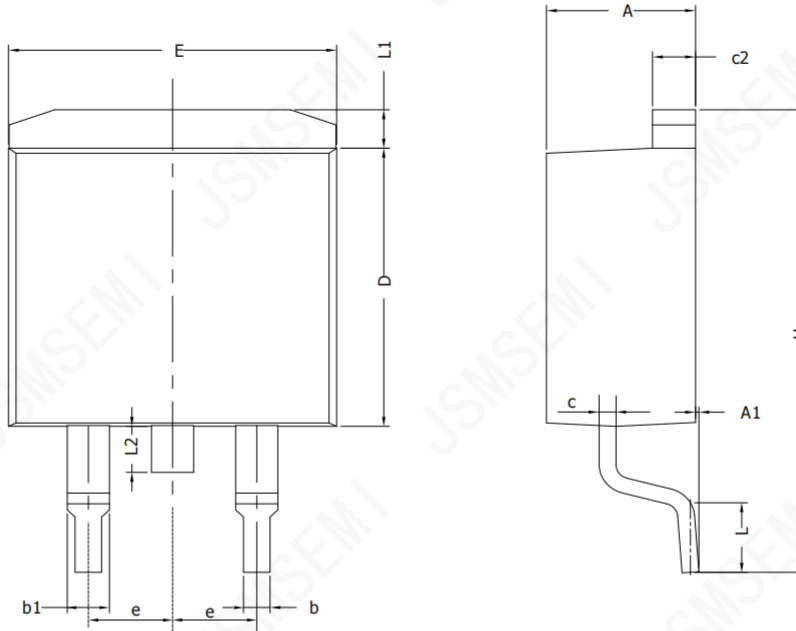

Figure 15: Normalized Transient Thermal Impedance Form Junction To Case

Package Information

TO-263-2



SYMBOL	MIN	NOM	MAX
A	4.30	4.57	4.72
A1	0	0.10	0.25
b	0.71	0.81	0.91
c	0.30	---	0.60
c2	1.17	1.27	1.37
D	8.50	---	9.35
E	9.80	---	10.45
e	2.54BSC		
H	14.70	---	15.75
L	2.00	2.30	2.74
L1	1.12	1.27	1.42
L2	---	---	1.75

Revision History

Rev.	Change	Date
V1.0	Initial version	6/27/2021

Important Notice

JSMSEMI Semiconductor (JSMSEMI) PRODUCTS ARE NEITHER DESIGNED NOR INTENDED FOR USE IN MILITARY AND/OR AEROSPACE, AUTOMOTIVE OR MEDICAL DEVICES OR SYSTEMS UNLESS THE SPECIFIC JSMSEMI PRODUCTS ARE SPECIFICALLY DESIGNATED BY JSMSEMI FOR SUCH USE. BUYERS ACKNOWLEDGE AND AGREE THAT ANY SUCH USE OF JSMSEMI PRODUCTS WHICH JSMSEMI HAS NOT DESIGNATED FOR USE IN MILITARY AND/OR AEROSPACE, AUTOMOTIVE OR MEDICAL DEVICES OR SYSTEMS IS SOLELY AT THE BUYER' S RISK.

JSMSEMI assumes no liability for application assistance or customer product design. Customers are responsible for their products and applications using JSMSEMI products.

Resale of JSMSEMI products or services with statements diferent from or beyond the parameters stated by JSMSEMI for that product or service voids all express and any implied warranties for the associated JSMSEMI product or s ervice. JSMSEMI is not responsible or liable for any such statements.

JSMSEMI All Rights Reserved. Information and data in this document are owned by JSMSEMI wholly and may not be edited, reproduced, or redistributed in any way without the express written consent from JSMSEMI.

Any and all information described or contained herein are subject to change without notice due to product/technology improvement, etc. When designing equipment, refer to the "Delivery Specification" for the JSMSEMI product that you intend to use.

For additional information please contact Kevin@jsmsemi.com or visit www.jsmsemi.com