

REV. (版本号)	DESCRIPTION (变更说明)	DATE (日期)	APPD (核准)

规格说明:Specifications:

电气特性:Electrical:

1. 额定电流: Current Rating
1.0A/contact terminal
2. 额定电压: Voltage Rating
30V DC
3. 接触阻抗: Contact Resistance
初始30MΩ MAX, 测试后50MΩ MAX
4. 耐电压: Dielectric Withstanding Voltage:
100 V AC For one minute
5. 绝缘阻抗: Insulation Resistance:
100MEGA ohms MIN

原材料:Raw material:

1. 塑胶: Plastic cement:
Hing Temperature Thermoplastics,
LCP Black
2. 端子: Contact: Copper Alloy C5191
3. 外壳: Shell: Copper Alloy C2680

电镀: Electroplate:

1. 端子: Contact: Plated Gold in Mating Area;
2. 外壳: Shell:
Nickel Plating

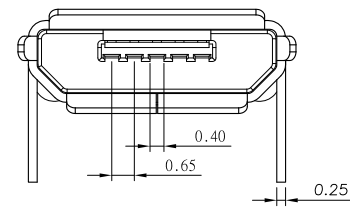
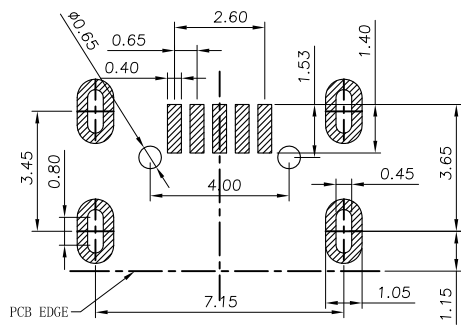
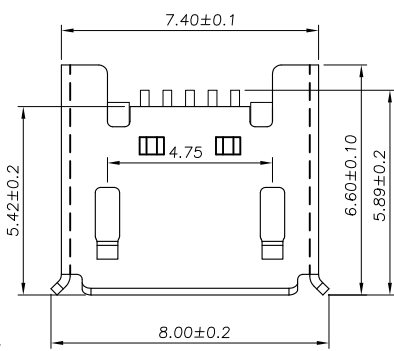
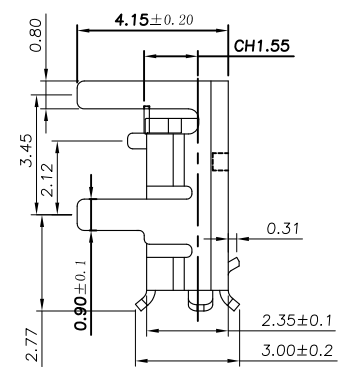
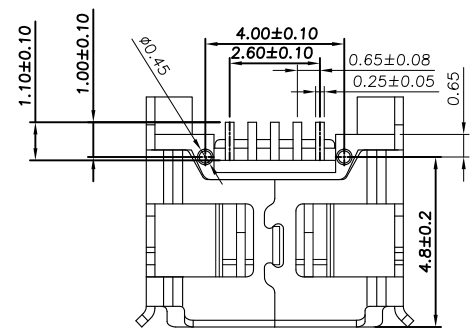
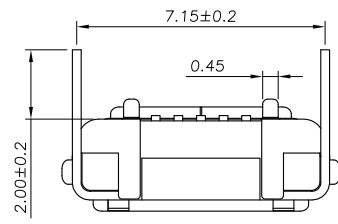

RECOMMENDED PCB LAYOUT
(TOL: ±0.05)

3E外壳 1G端子

 深圳市宇文发电子科技有限公司 Shen Zhen Yu Wen Fa Electronics Technology Co., Ltd TEL: 0755-27711235 FAX: 0755-27712683	页码 (SHEET)	1/1	单位 (UNIT): MM
	版本 (REV)	A0	比例 (SCALE) 1:1
	日期 (DATE)	2013.08.28	
	设计 (DESIGN)	陈钦虎	未注公差 TOLERANCE UNSPECIFIED
	图号 (DWG NO)	P-MCF-051	X.X ±0.30 X.XX ±0.20 X.XXX ±0.10 X° ±5° X.X° ±2°
品名 (ITEM NO)	MICRO USB 5P/F DIP B型有柱 (四脚2.0/双卡点/端子加长0.55mm)		审核 (CHECKED)
料号 (PART NO)	PMCFB-R22A-036		核准 (APPROVED)

RoHS Compliant

REV.	ECN NO	DESCRIPTION	REVISER	DATE
A/0				
A/1				



① 胶盘

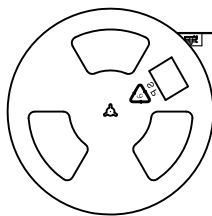
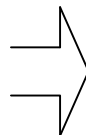

② 1000pcs/盘

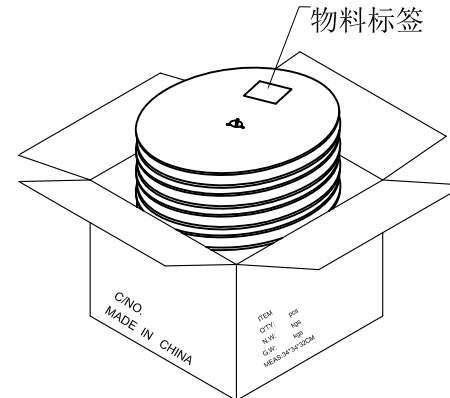
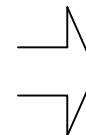
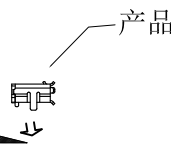

③ 10盘/箱 (10 Kpcs)

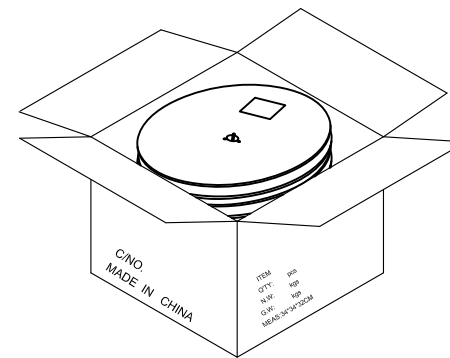
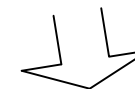

④ 每箱装10盘,若尾数箱在空间处加装填充物.

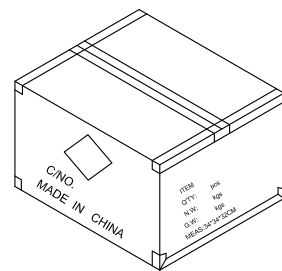
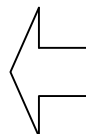

⑤ 外箱用透明胶纸带封"工"字型.

外箱物料标签

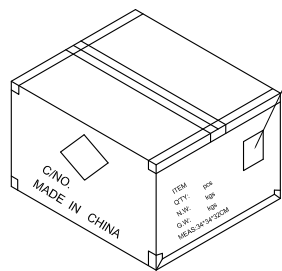

⑥ 依图示粘贴产品或ROHS标签.

- 备注:
1. 胶盘规格: 330*16mm
 2. 每盘装1.0K pcs;
 3. 每箱装10盘 (10K pcs);
 4. 外箱尺寸:长*宽*高: 34*34*32cm;
 5. 外箱用透明胶纸带封"工"字型;
 6. 依外箱图示位置粘贴好产品或ROHS标签.

图号 (DWG NO)		单位 (UNIT): MM	深圳宇文发电子科技有限公司 TEL:0755-27711235 FAX:0755-27712683	
日期 (DATE)	2012.06.27	比例 (SCALE) 1:1		
版次 (REV): A/0	页/次(PAGE): 1/1		品名 (ITEM NO) MICRO USB 5P/F 卷装系列(1000PCS/盘) 料号 (PART NO)	
设计 (DESIGN)	李丰桔	包装规范		
审核 (CHECKED)	吴华兴			
核准 (APPROVED)				