



Description

The CSD17505Q5A uses advanced trench technology to provide excellent $R_{DS(ON)}$, low gate charge and operation with gate voltages as low as 4.5V. This device is suitable for use as a Battery protection or in other Switching application.

General Features

$V_{DS} = 30V$ $I_D = 120A$

$R_{DS(ON)} < 2.6m\Omega$ $V_{GS} = 10V$

Application

Battery protection

Load switch

Uninterruptible power supply



DFN5X6-8L

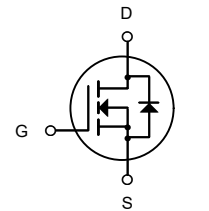

N-Channel MOSFET

Package Marking and Ordering Information

Product ID	Pack	Brand	Qty(PCS)
CSD17505Q5A	DFN5X6-8L	HXY MOSFET	5000

Absolute Maximum Ratings (Tc=25°C unless otherwise noted)

Symbol	Parameter	Rating	Units
V_{DS}	Drain-Source Voltage	30	V
V_{GS}	Gate-Source Voltage	± 20	V
$I_D @ T_C = 25^\circ C$	Continuous Drain Current, $V_{GS} @ 10V$	120	A
$I_D @ T_C = 100^\circ C$	Continuous Drain Current, $V_{GS} @ 10V$	57	A
I_{DM}	Pulsed Drain Current	360	A
EAS	Single Pulse Avalanche Energy	125	mJ
P_D	Total Power Dissipation ⁴	115	W
T_{STG}	Storage Temperature Range	-55 to 175	°C
T_J	Operating Junction Temperature Range	-55 to 175	°C
$R_{\theta JA}$	Thermal Resistance Junction-Ambient	62	°C/W
$R_{\theta JC}$	Thermal Resistance Junction-Case ²	1.3	°C/W



Electrical Characteristics (T_J=25°C, unless otherwise noted)

Symbol	Parameter	Conditions	Min	Typ	Max	Units
Off Characteristics						
BV _{DSS}	Drain-Source Breakdown Voltage	V _{GS} =0V, I _D =250μA	30	---	---	V
I _{DSS}	Zero Gate Voltage Drain Current	V _{GS} =0V, V _{DS} =30V	---	---	1	μA
I _{GSS}	Gate-Source Leakage Current	V _{GS} =±20V, V _{DS} =0A	---	---	±100	nA
On Characteristics³						
V _{GS(th)}	Gate-Source Threshold Voltage	V _{GS} =V _{DS} , I _D =250μ A	1	1.6	2.5	V
R _{DS(ON)}	Drain-Source On Resistance ²	V _{GS} =10V, I _D =20A	---	2.6	3.3	mΩ
		V _{GS} =4.5V, I _D =10A	---	3.8	5	
Dynamic Characteristics						
C _{iss}	Input Capacitance	V _{DS} =25V, V _{GS} =0V, f=1MHz	---	2218	---	pF
C _{oss}	Output Capacitance		---	480	---	
C _{rss}	Reverse Transfer Capacitance		---	340	---	
Switching Characteristics						
t _{d(on)}	Turn-On Delay Time ^{3,4}	V _{DD} =15V, I _D =15A, R _G =3.3Ω V _{GS} =10V	---	12.6	---	ns
t _r	Rise Time ^{3,4}		---	19.5	---	ns
t _{d(off)}	Turn-Off Delay Time ^{3,4}		---	42.8	---	ns
t _f	Fall Time ^{3,4}		---	13.2	---	ns
Q _g	Total Gate Charge ^{3,4}	V _{GS} =4.5V, V _{DS} =15V, I _D =20A	---	24	---	nC
Q _{gs}	Gate-Source Charge ^{3,4}		---	4.2	---	nC
Q _{gd}	Gate-Drain "Miller" Charge ^{3,4}		---	13	---	nC
Drain-Source Diode Characteristics						
V _{SD}	Source-Drain Diode Forward Voltage ³	V _{GS} =0V, I _S =1A	---	---	1	V
I _S	Continuous Source Current	V _G =V _D =0V, Force Current	---	---	120	A
I _{SM}	Pulsed Source Current		---	---	360	A
T _{rr}	Reverse Recovery Time	V _{GS} =30V, I _S =1A, di/dt=100A/μs	---	258	---	NS
Q _{rr}	Reverse Recovery Charge	T _J =25°C	---	324	---	NC

Notes:

1. Repetitive Rating : Pulsed width limited by maximum junction temperature.
2. V_{DD}=25V, V_{GS}=10V, L=0.1mH, I_{AS}=50A., R_G=25Ω, Starting T_J=25°C.
3. The data tested by pulsed, pulse width ≤ 300us, duty cycle ≤ 2%.
4. Essentially independent of operating temperature.



Typical Characteristics

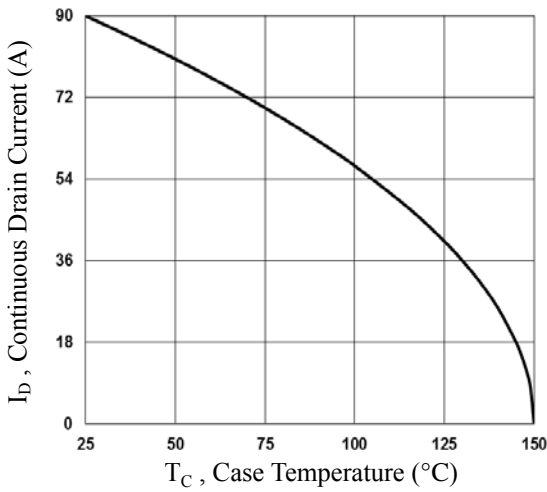

Fig.1 Continuous Drain Current vs. T_C

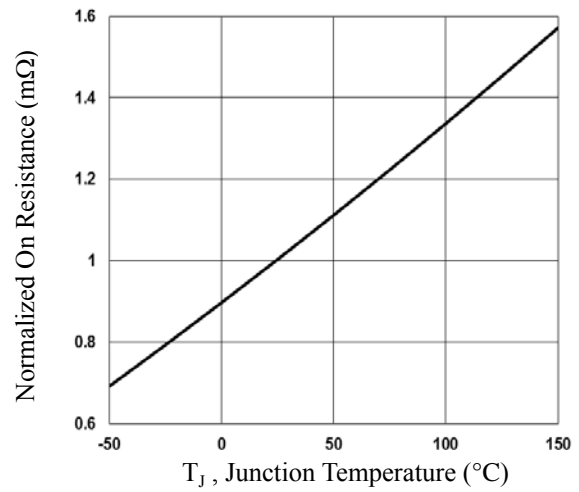

Fig.2 Normalized $R_{DS(on)}$ vs. T_J

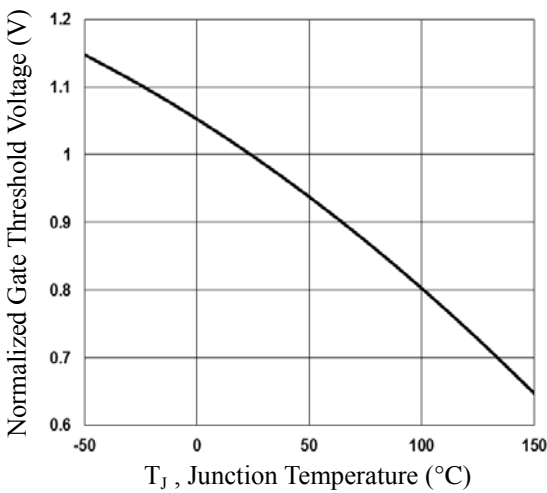

Fig.3 Normalized V_{th} vs. T_J

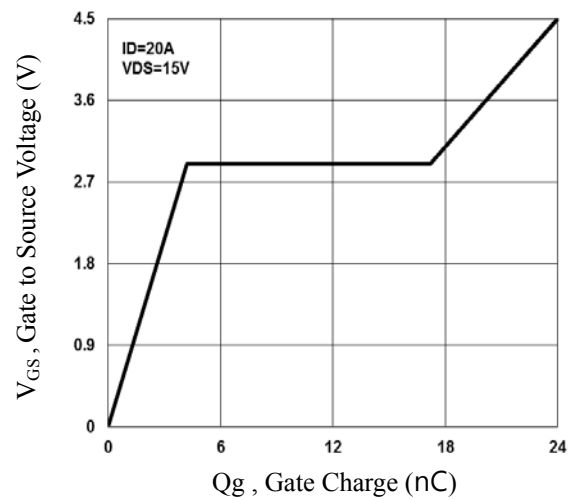

Fig.4 Gate Charge Waveform

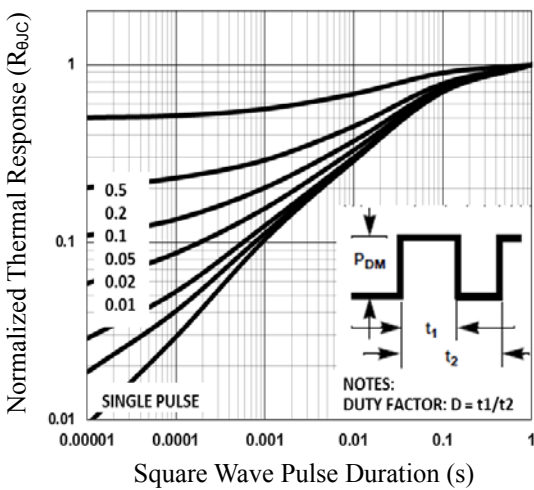

Fig.5 Normalized Transient Impedance

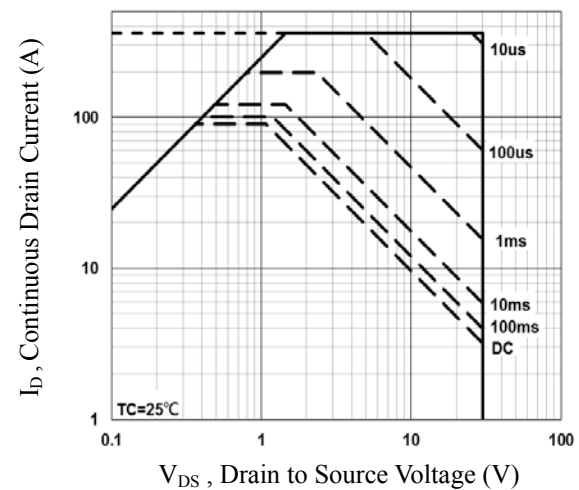

Fig.6 Maximum Safe Operation Area

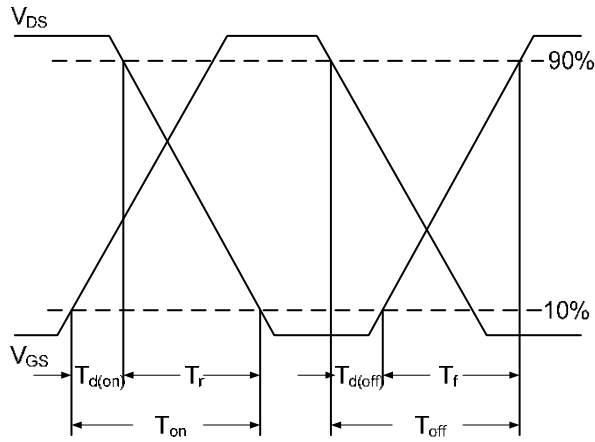

Fig.7 Switching Time Waveform

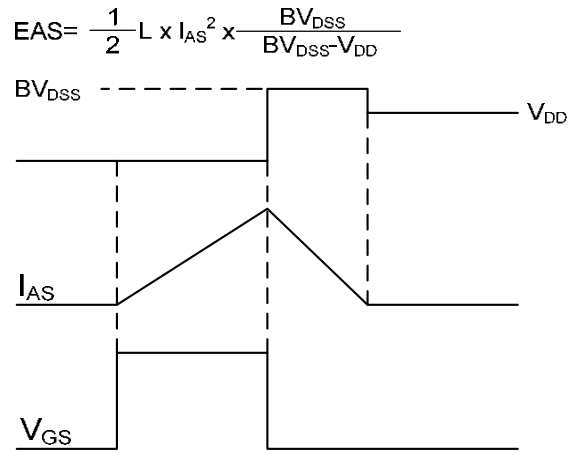
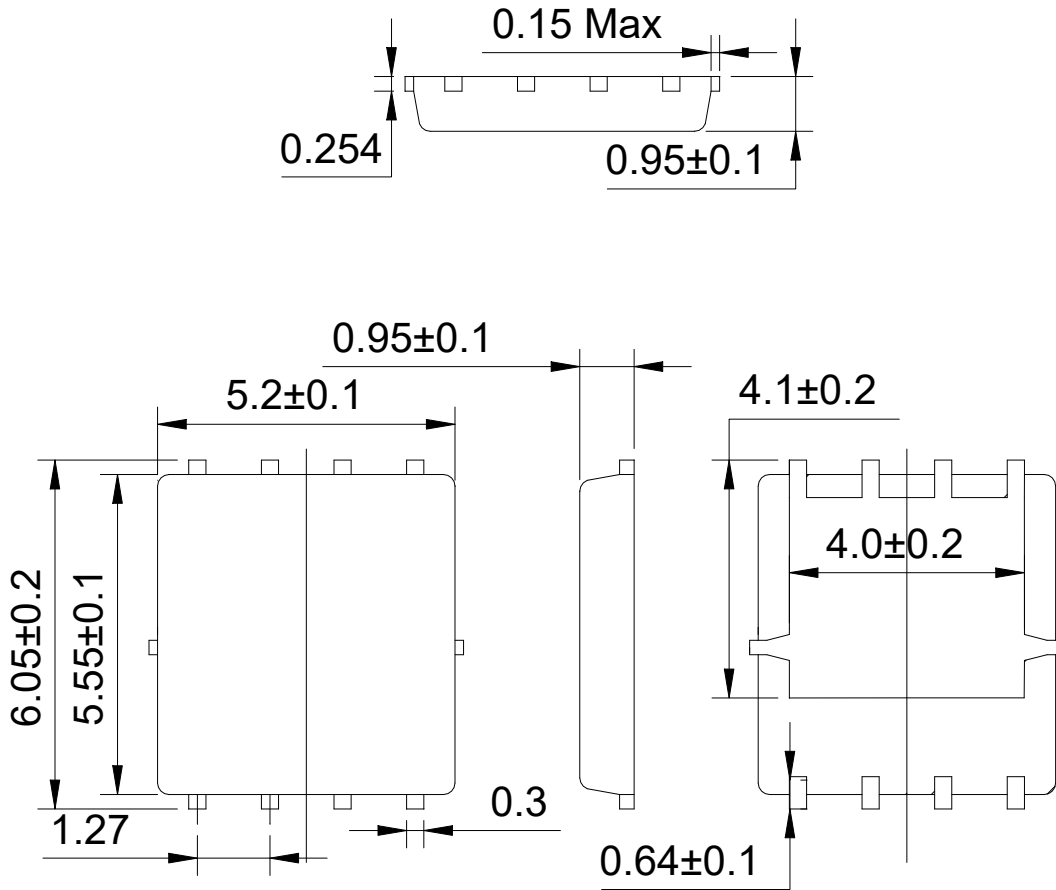

Fig.8 EAS Waveform



DFN5X6-8L Package Information

Unit:mm





Attention

- Any and all HUA XUAN YANG ELECTRONICS products described or contained herein do not have specifications that can handle applications that require extremely high levels of reliability, such as life-support systems, aircraft's control systems, or other applications whose failure can be reasonably expected to result in serious physical and/or material damage. Consult with your HUA XUAN YANG ELECTRONICS representative nearest you before using any HUA XUAN YANG ELECTRONICS products described or contained herein in such applications.
- HUA XUAN YANG ELECTRONICS assumes no responsibility for equipment failures that result from using products at values that exceed, even momentarily, rated values (such as maximum ratings, operating condition ranges, or other parameters) listed in products specifications of any and all HUA XUAN YANG ELECTRONICS products described or contained herein.
- Specifications of any and all HUA XUAN YANG ELECTRONICS products described or contained herein stipulate the performance, characteristics, and functions of the described products in the independent state, and are not guarantees of the performance, characteristics, and functions of the described products as mounted in the customer's products or equipment. To verify symptoms and states that cannot be evaluated in an independent device, the customer should always evaluate and test devices mounted in the customer's products or equipment.
- HUA XUAN YANG ELECTRONICS CO.,LTD. strives to supply high-quality high-reliability products. However, any and all semiconductor products fail with some probability. It is possible that these probabilistic failures could give rise to accidents or events that could endanger human lives, that could give rise to smoke or fire, or that could cause damage to other property. When designing equipment, adopt safety measures so that these kinds of accidents or events cannot occur. Such measures include but are not limited to protective circuits and error prevention circuits for safe design, redundant design, and structural design.
- In the event that any or all HUA XUAN YANG ELECTRONICS products(including technical data, services) described or contained herein are controlled under any of applicable local export control laws and regulations, such products must not be exported without obtaining the export license from the authorities concerned in accordance with the above law.
- No part of this publication may be reproduced or transmitted in any form or by any means, electronic or mechanical, including photocopying and recording, or any information storage or retrieval system, or otherwise, without the prior written permission of HUA XUAN YANG ELECTRONICS CO.,LTD.
- Information (including circuit diagrams and circuit parameters) herein is for example only ; it is not guaranteed for volume production. HUA XUAN YANG ELECTRONICS believes information herein is accurate and reliable, but no guarantees are made or implied regarding its use or any infringements of intellectual property rights or other rights of third parties.
- Any and all information described or contained herein are subject to change without notice due to product/technology improvement, etc. When designing equipment, refer to the "Delivery Specification" for the HUA XUAN YANG ELECTRONICS product that you intend to use.