

1-1823449-1 ✓ ACTIVE

AMP | LEAVYSEAL

TE Internal #: 1-1823449-1

Housing for Male Terminals, Wire-to-Wire, 22 Position, .157 in / .236 in [4 mm / 6 mm] Centerline, Sealable, Black, Signal, Panel Mount, LEAVYSEAL

[View on TE.com >](#)



[Connectors](#) > [Automotive Connectors](#) > [Automotive Housings](#) > [LEAVYSEAL Housings](#)



Connector System: **Wire-to-Wire**

Number of Positions: **22**

Connector & Housing Type: **Housing for Male Terminals**

Centerline (Pitch): **4 mm, 6 mm [ .157 in, .236 in ]**

Sealable: **Yes**

[All LEAVYSEAL Housings \(64\)](#)

## Features

### Product Type Features

Mixed & Hybrid Connector	Yes
Connector Shape	Rectangular
Connector System	Wire-to-Wire
Connector & Housing Type	Housing for Male Terminals
Sealable	Yes
Primary Locking Feature	On the Terminal

### Configuration Features

Number of Positions	22
Number of Rows	3, 4

### Electrical Characteristics

Operating Voltage	42 VAC
Nominal Voltage Architecture	12 V, 24 V, 42 V

### Body Features

Cable Exit Angle	180°
Primary Product Color	Black
Connector & Keying Code	A



### Contact Features

Contact Size	1.6mm, 2.8mm
Contact Type	Tab
Mating Tab Width	1.6 mm, 2.8 mm [.063 in][.11 in]
Contact Current Rating (Max)	40 A

### Mechanical Attachment

Terminal Position Assurance	Yes
Strain Relief	Without
Mating Alignment Type	Keyed
Mating Alignment	With
Connector Mounting Type	Panel Mount

### Housing Features

Housing Material	PBT GF
Centerline (Pitch)	4 mm, 6 mm [.157 in][.236 in]

### Dimensions

Connector Height	49 mm [1.94 in]
Product Width	32.4 mm [1.27 in]
Product Length	48.4 mm [1.9 in]
Row-to-Row Spacing	6 mm [.236 in]

### Usage Conditions

Operating Temperature (Max)	70 °C, 75 °C, 80 °C, 85 °C, 90 °C, 100 °C, 105 °C, 110 °C [158 °F][167 °F][176 °F][185 °F] [194 °F][212 °F][221 °F][230 °F]
Operating Temperature Range	-40 – 120 °C [-40 – 248 °F]

### Operation/Application

Circuit Application	Signal
---------------------	--------

### Industry Standards

Degree of Protection	IP67, IP69K
UL Flammability Rating	UL 94V-0

### Packaging Features

Packaging Quantity	285
Packaging Method	Box



Other

Serviceable	Yes
Connector Position Assurance Capable	No

Product Compliance

[For compliance documentation, visit the product page on TE.com>](#)

EU RoHS Directive 2011/65/EU	Compliant
EU ELV Directive 2000/53/EC	Compliant
China RoHS 2 Directive MIIT Order No 32, 2016	No Restricted Materials Above Threshold
EU REACH Regulation (EC) No. 1907/2006	Current ECHA Candidate List: JUNE 2023 (235) Candidate List Declared Against: JUNE 2023 (235) Does not contain REACH SVHC
Halogen Content	Low Halogen - Br, Cl, F, I < 900 ppm per homogenous material. Also BFR/CFR/PVC Free
Solder Process Capability	Not applicable for solder process capability

Product Compliance Disclaimer

This information is provided based on reasonable inquiry of our suppliers and represents our current actual knowledge based on the information they provided. This information is subject to change. The part numbers that TE has identified as EU RoHS compliant have a maximum concentration of 0.1% by weight in homogenous materials for lead, hexavalent chromium, mercury, PBB, PBDE, DBP, BBP, DEHP, DIBP, and 0.01% for cadmium, or qualify for an exemption to these limits as defined in the Annexes of Directive 2011/65/EU (RoHS2). Finished electrical and electronic equipment products will be CE marked as required by Directive 2011/65/EU. Components may not be CE marked. Additionally, the part numbers that TE has identified as EU ELV compliant have a maximum concentration of 0.1% by weight in homogenous materials for lead, hexavalent chromium, and mercury, and 0.01% for cadmium, or qualify for an exemption to these limits as defined in the Annexes of Directive 2000/53/EC (ELV). Regarding the REACH Regulation, the information TE provides on SVHC in articles for this part number is based on the latest European Chemicals Agency (ECHA) 'Guidance on requirements for substances in articles' posted at this URL: <https://echa.europa.eu/guidance-documents/guidance-on-reach>

Compatible Parts



TE Part # 964972-1  
EINZELLEITERDICHTNG



TE Part # 828905-1  
SINGLE-WIRE-SEAL(5MM HOLE)



TE Part # 1-1823440-3  
22POS, MIXED,REC HSG,ASSY, SEALED



TE Part # CAT-T4827-T273  
TIMER, RECEPTACLE AND TAB



TE Part # 828904-1  
SINGLE WIRE SEAL FOR J.P.T.CON



TE Part # 2-964269-2  
TAB A 1.6x0.6 CONTACT CF SWS Ag

### Also in the Series | LEAVYSEAL

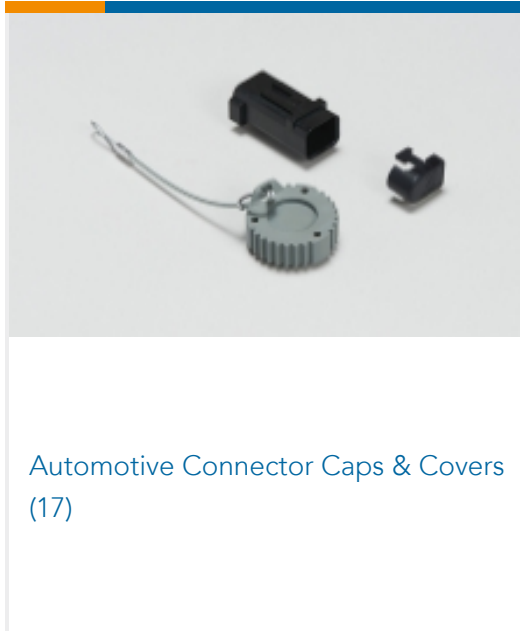

Automotive Connector Caps & Covers  
(17)

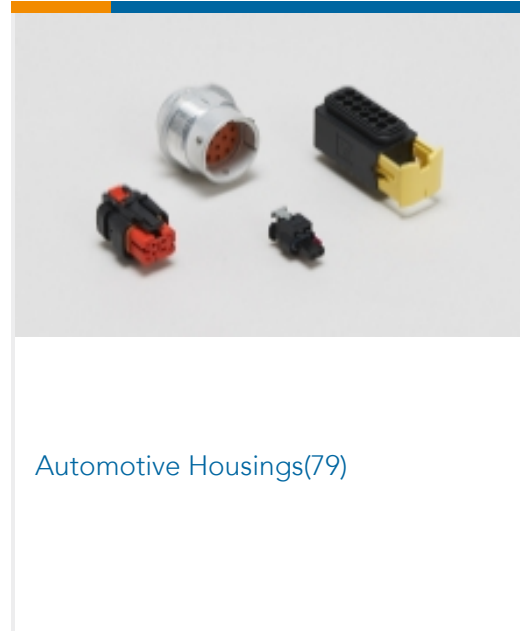

Automotive Housings(79)

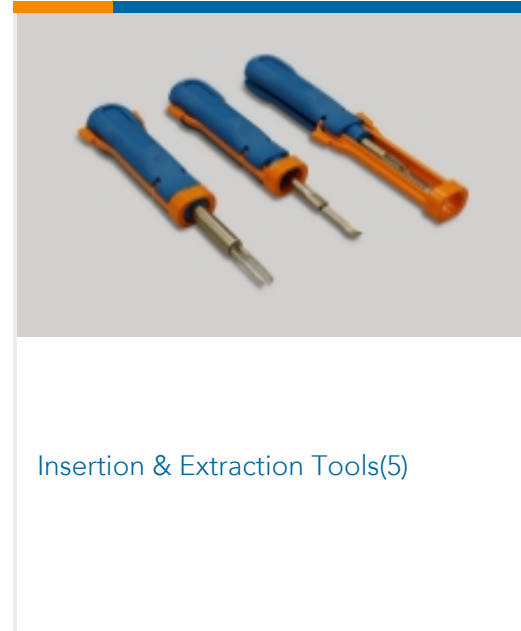

Insertion & Extraction Tools(5)

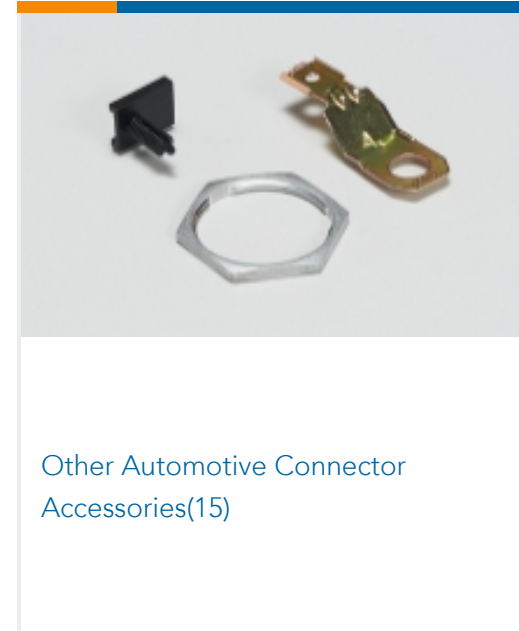

Other Automotive Connector  
Accessories(15)



PCB Headers & Receptacles(16)

### Customers Also Bought



TE Part #1-1670214-1  
7POS, MIXED,TAB HSG,ASSY,CODA



TE Part #T4113012051-000  
M12 M, 5P GOLD A\_CODE RA  
SHIELDED PG9

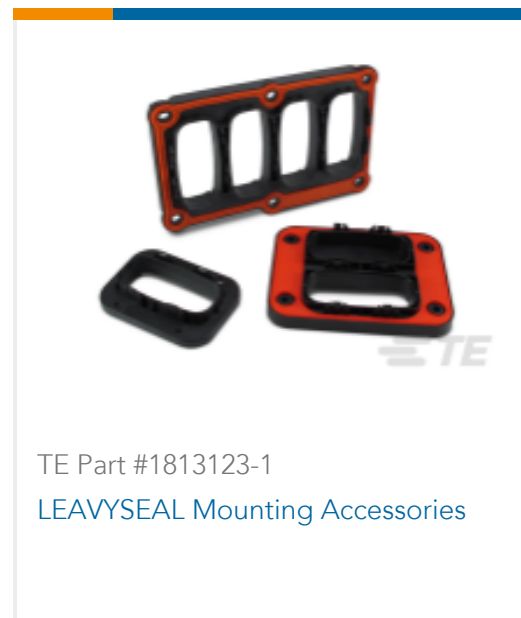

TE Part #1813123-1  
LEAVYSEAL Mounting Accessories

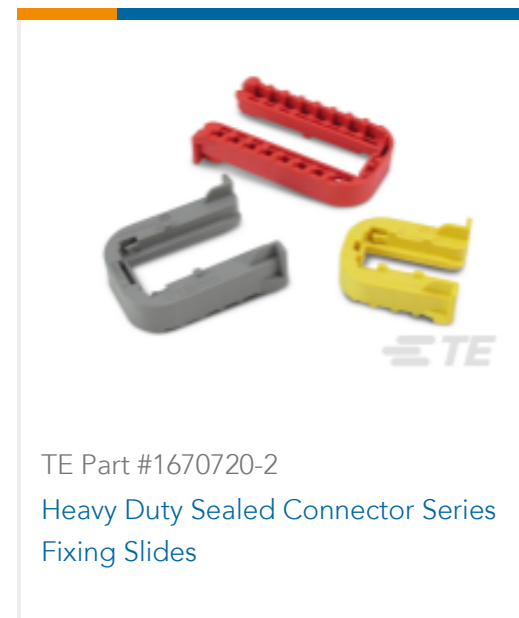

TE Part #1670720-2  
Heavy Duty Sealed Connector Series  
Fixing Slides

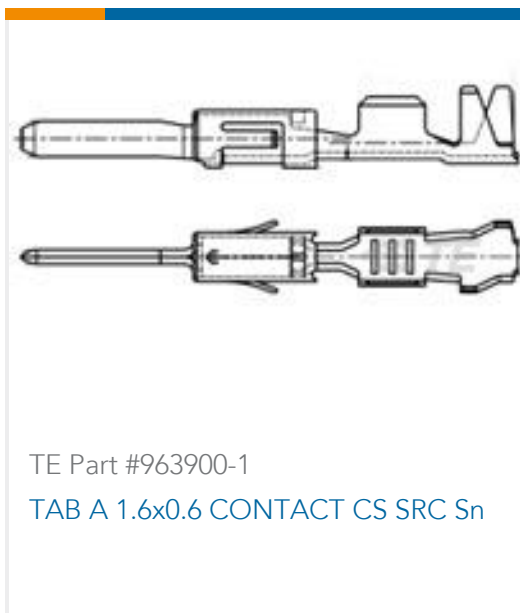

TE Part #963900-1  
TAB A 1.6x0.6 CONTACT CS SRC Sn



TE Part #EL6596-000  
RBK-105-KIT-0103-A0



TE Part #1-1823440-1  
22POS, MIXED,REC HSG,ASSY,  
SEALED



TE Part #2-1823449-1  
22POS, MIXED,TAB HSG,ASSY



## Documents

### Product Drawings

[22POS, MIXED,TAB HSG,ASSY](#)

English

---

### CAD Files

Customer View Model

[ENG\\_CVM\\_CVM\\_1-1823449-1\\_A.2d\\_dxf.zip](#)

English

[3D PDF](#)

3D

Customer View Model

[ENG\\_CVM\\_CVM\\_1-1823449-1\\_A.3d\\_igs.zip](#)

English

Customer View Model

[ENG\\_CVM\\_CVM\\_1-1823449-1\\_A.3d\\_stp.zip](#)

English

By downloading the CAD file I accept and agree to the [Terms and Conditions](#) of use.

---

### Datasheets & Catalog Pages

[ICT Terminals and Connectors Catalogue](#)

English

[CONNECTOR SELECTOR](#)

English

---

### Product Specifications

[Application Specification](#)

German