

REV.	REVISION DESCRIPTION	DATE

技术特性/Specifications:
 额定电流 Rated current: 3A AC\DC
 额定电压 Rated voltage: 125V AC\DC
 接触电阻 Contact resistance: 20mΩ max
 绝缘电阻 Insulation resistance: 1000MΩ min
 耐压 Withstand voltage: 500V AC/ minute
 环境温度 Ambient temperature: -40℃ to 105℃
 材料/Materials:
 针座Wafer: LCP UL94V-0
 插针Pin Material : 黄铜Brass / Tin-Plated.

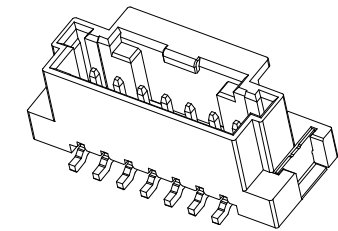
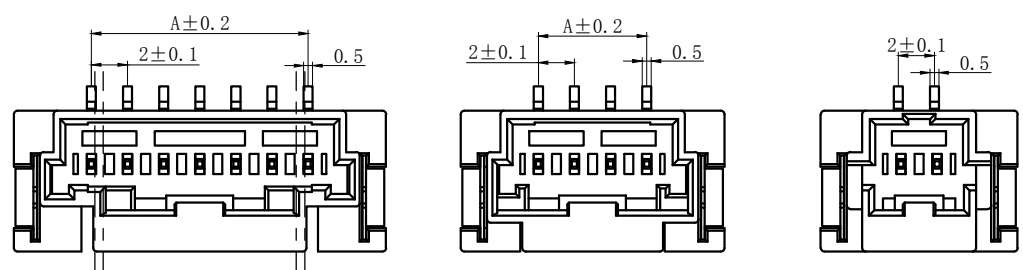
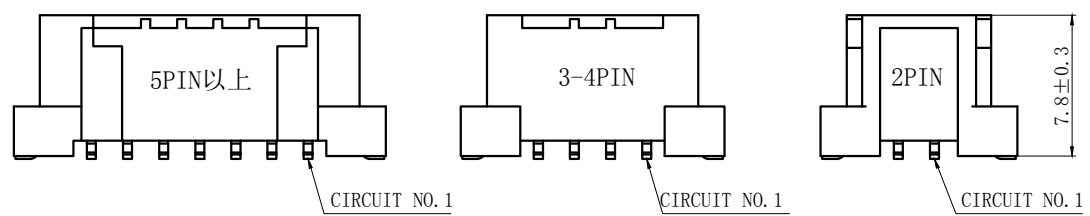
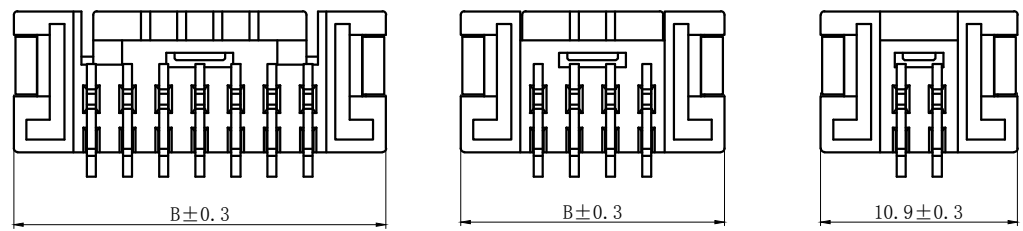

DLXXXX - XX X - X XX - X X - X - XX
 1 2 3 4 5 6 7 8 9

- PART NO.
- NO. OF CIRCUIT
- CONN. TYPE
- MATERIAL: 0:PA66 V0 1:PA66 V1 2:PA66 V2
3:PA66 V0 750℃ 4:LCP 5:PBT
6:PA9T 7:PA6T 8:GF PA66
- COLOR: NA:NATURE RE:RED BR:BROWN
GY:GREY BK:BLACK YE:YELLOW
BL:BLUE GR:GREEN PU:PURPLE PI:PINK
OR:ORANGE TR:TRANSPARENT OT:OTHER
- CONTACT MATERIAL: P:PHOSPHOR BRONZE B:BRASS
- FINISH: T:TIN MT:MATT TIN BG/QG:GOLD S:SILVER
- STYLE: Z:WITHOUT K K:WITH K
- SERIAL NUMBER: 00.01.02.....

3	③	基座	LCP	1	UL94V-0
2	②	焊片	黄铜	2	镀锡
1	①	接触件	黄铜	N*	镀锡
序号	图号	名称	材料	数量	附件

Circuits	Type	Dimension mm		Circuits	Type	Dimension mm	
		A	B			A	B
2	PHM-2AB	2.00	10.90	9	PHM-9AB	16.00	24.60
3	PHM-3AB	4.00	12.60	10	PHM-10AB	18.00	26.60
4	PHM-4AB	6.00	14.60	11	PHM-11AB	20.00	28.60
5	PHM-5AB	8.00	16.60	12	PHM-12AB	22.00	30.60
6	PHM-6AB	10.00	18.60	13	PHM-13AB	24.00	32.60
7	PHM-7AB	12.00	20.60	14	PHM-14AB	26.00	34.60
8	PHM-8AB	14.00	22.60	15	PHM-15AB	28.00	36.60

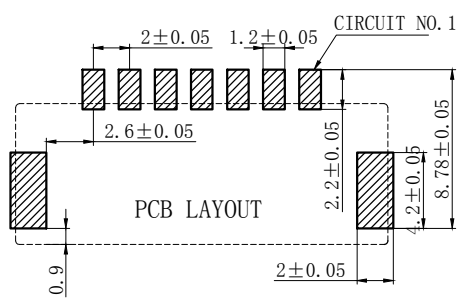

GENERAL TOLERANCES (UNLESS SPECIFIED)		ZHE JIANG DELI CONNECTORS CO., LTD	
.X: ± 0.25	X°: ± 3.0°	PRODUCT NAME: DL20040 (PHM)-AB	TITLE: 2.00 mm Pitch Wire To Board SMT Wafer
.XX: ± 0.15	.X°: ± 2.0°	DR: Chen Quan Long	DATE: 23/08/20
.XXX: ± 0.01	.XX°: ± 1.0°	CHKD: Wu Hui	DATE: 23/08/20
FINISH:		APPD: Ren An De	DATE: 23/08/20
DRAWING NO: QC-DL20040-XXB-XXX-XX-X-XX		PART NO: DL20040-XXB-XXX-XX-X-XX	
		SCALE: N/A	PAGE: 1/1
		UNITS: mm	REV.: A

REV.	REVISION DESCRIPTION	DATE

A

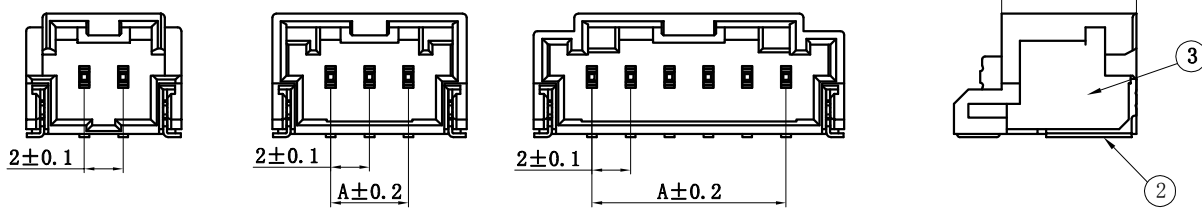

技术特性/Specifications:
 额定电流 Rated current: 3A AC\DC
 额定电压 Rated voltage: 125V AC\DC
 接触电阻 Contact resistance: 20mΩ max
 绝缘电阻 Insulation resistance: 1000MΩ min
 耐压 Withstand voltage: 500V AC/ minute
 环境温度 Ambient temperature: -40℃ to 105℃
 材料/Materials:
 针座Wafer: LCP UL94V-0
 插针Pin Material : 黄铜Brass / Tin-Plated.

B

CIRCUIT NO.1

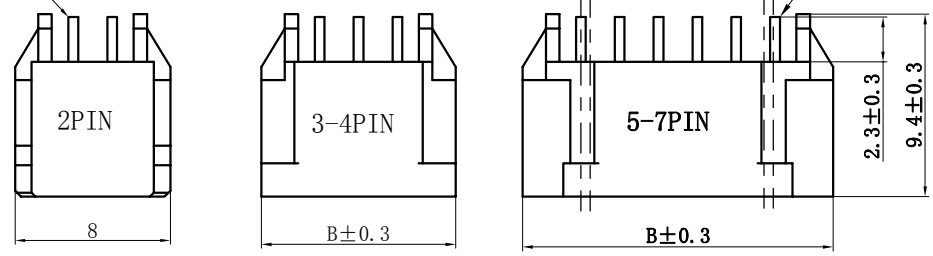

C

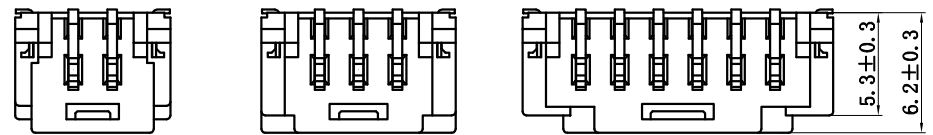

D

Circuits	Product name	Dimension mm	
		A	B
2	PHM-2AWB	2.00	8.00
3	PHM-3AWB	4.00	10.00
4	PHM-4AWB	6.00	12.00
5	PHM-5AWB	8.00	14.00
6	PHM-6AWB	10.00	16.00
7	PHM-7AWB	12.00	18.00

E

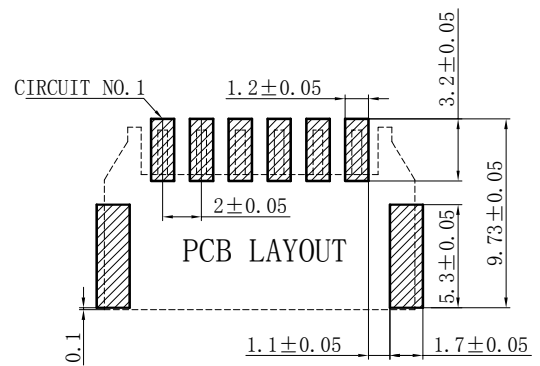

F

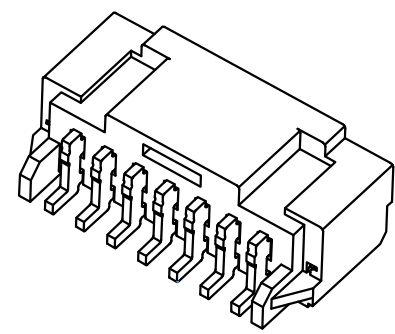

3	③	基座	LCP	1	UL94V-0
2	②	焊片	黄铜	2	镀锡
1	①	接触件	黄铜	N*	镀锡
序号	图号	名称	材料	数量	附件

GENERAL TOLERANCES (UNLESS SPECIFIED)		ZHE JIANG DELI CONNECTORS CO., LTD			
.X: ± 0.25	X°: ± 3.0°	PRODUCT NAME: DL20040 (PHM)-AWB		TITLE: 2.00 mm Pitch Wire To Board SMT Wafer	
.XX: ± 0.15	.X°: ± 2.0°	DR: Chen Quan Long	DATE: 23/08/20	PART NO:	
.XXX: ± 0.01	.XX°: ± 1.0°	CHKD: Wu Hui	DATE: 23/08/20	SCALE: N/A	PAGE: 1/2
DRAWING NO:		APPD: Ren An De	DATE: 23/08/20	UNITS: mm	REV.: A

A

B

C

D

E

F

REV.	REVISION DESCRIPTION	DATE

A

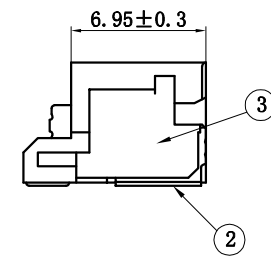
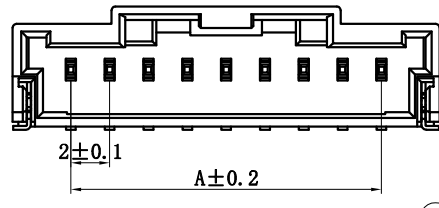
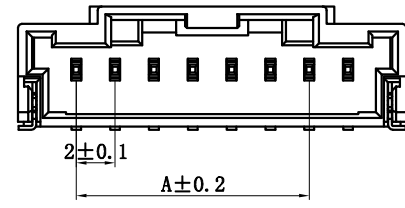

技术特性/Specifications:
 额定电流 Rated current: 3A AC\DC
 额定电压 Rated voltage: 125V AC\DC
 接触电阻 Contact resistance: 20mΩ max
 绝缘电阻 Insulation resistance: 1000MΩ min
 耐压 Withstand voltage: 500V AC/ minute
 环境温度 Ambient temperature: -40°C to 105°C
 材料/Materials:
 针座Wafer: LCP UL94V-0
 插针Pin Material : 黄铜Brass / Tin-Plated.

B

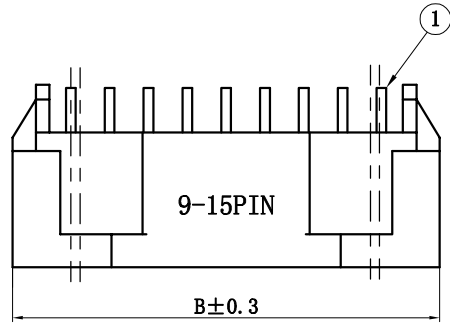
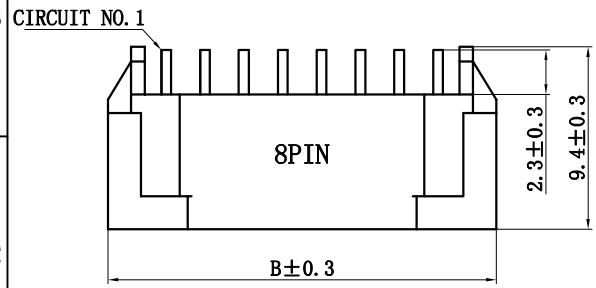

C

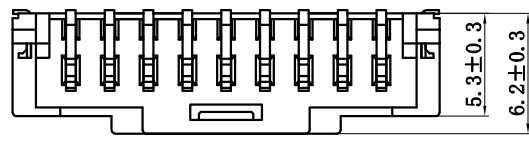
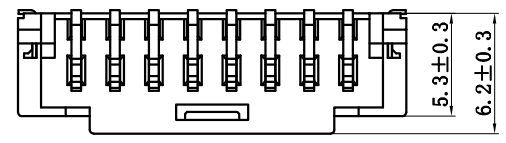

D

Circuits	Product name	Dimension mm	
		A	B
8	PHM-8AWB	14.00	20.00
9	PHM-9AWB	16.00	22.00
10	PHM-10AWB	18.00	24.00
11	PHM-11AWB	20.00	26.00
12	PHM-12AWB	22.00	28.00
13	PHM-13AWB	24.00	30.00
14	PHM-14AWB	26.00	32.00
15	PHM-15AWB	28.00	34.00

E

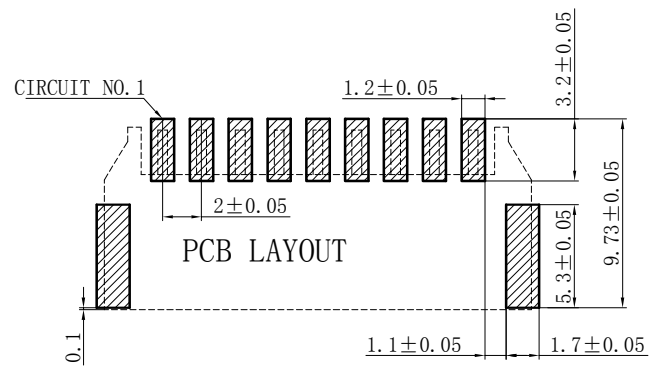

F

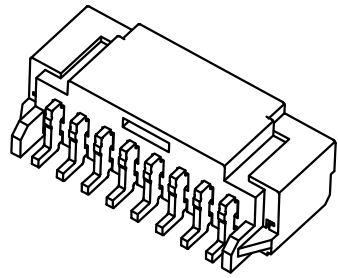

3	③	基座	LCP	1	UL94V-0
2	②	焊片	黄铜	2	镀锡
1	①	接触件	黄铜	N*	镀锡
序号	图号	名称	材料	数量	附件

GENERAL TOLERANCES (UNLESS SPECIFIED)		ZHE JIANG DELI CONNECTORS CO., LTD			
.X: ± 0.25	X°: ± 3.0°	PRODUCT NAME:	TITLE: 2.00 mm Pitch		
.XX: ± 0.15	.X°: ± 2.0°	DL20040 (PHM)-AWB	Wire To Board SMT Wafer		
.XXX: ± 0.01	.XX°: ± 1.0°	DR: Chen Quan Long	DATE: 23/08/20	PART NO:	
FINISH:		CHKD: Wu Hui	DATE: 23/08/20	SCALE: N/A	PAGE: 2/2
DRAWING NO:		APPD: Ren An De	DATE: 23/08/20	UNITS: mm	REV.: A

A

B

C

D

E

F

REV.	REVISION DESCRIPTION	DATE	APPD

NOTES

Available in 02 through 15 Circuits.
 Match with DL20040 series housing
 Material : PBT UL94V-0(2).
 Accepts DL20040-T Crimp Terminal.

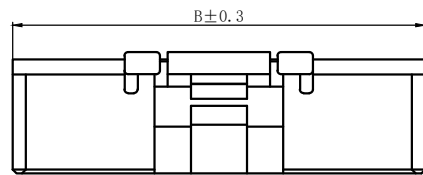
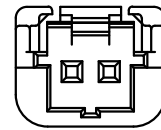
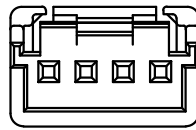
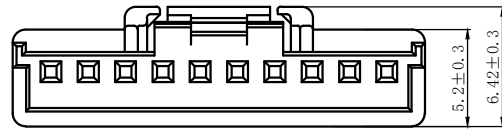

5-15PIN

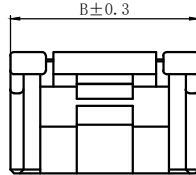

3-4PIN

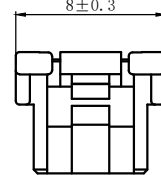

2PIN

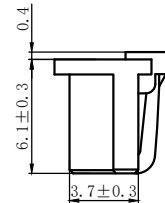

3-15PIN

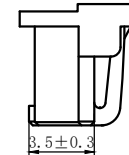

2PIN

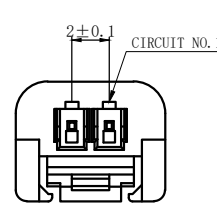
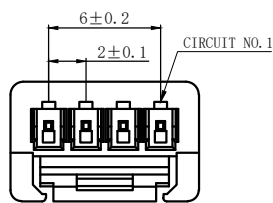
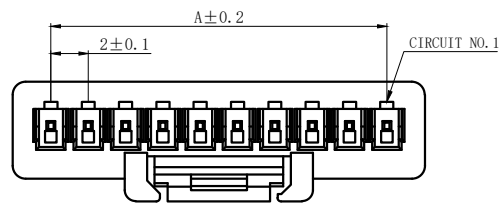

ORDERING INFORMATION

DLXXXX - XX X - X XX - XX
 1 2 3 4 5 6

- PART NO.
- .NO. OF CIRCUIT
- CONN. TYPE
- MATERIAL: 0:PA66 V0 1:PA66 V1 2:PA66 V2
 3:PA66 V0 750°C 4:LCP 5:PBT
 6:PA9T 7:PA6T 8:GF PA66
- COLOR: NA:NATURE RE:RED BR:BROWN
 GY:GREY BK:BLACK YE:YELLOW
 BL:BLUE GR:GREEN PU:PURPLE PI:PINK
 OR:ORANGE TR:TRANSPARENT OT:OTHER
- SERIAL NUMBER: 00.01.02.....

Circuits	Type	Dimension mm		Circuits	Type	Dimension mm	
		A	B			A	B
2	PHM-2Y	2.00	8.00	9	PHM-9Y	16.00	20.10
3	PHM-3Y	4.00	8.10	10	PHM-10Y	18.00	22.10
4	PHM-4Y	6.00	10.10	11	PHM-11Y	20.00	24.10
5	PHM-5Y	8.00	12.10	12	PHM-12Y	22.00	26.10
6	PHM-6Y	10.00	14.10	13	PHM-13Y	24.00	28.10
7	PHM-7Y	12.00	16.10	14	PHM-14Y	26.00	30.10
8	PHM-8Y	14.00	18.10	15	PHM-15Y	28.00	32.10

GENERAL TOLERANCES (UNLESS SPECIFIED)		ZHE JIANG DELI CONNECTORS CO., LTD	
.X: ± 0.25	.X°: ± 3.0°	PRODUCT NAME: DL20040 (PHM)-Y	TITLE: 2.50 mm Pitch Housing
.XX: ± 0.15	.X°: ± 2.0°	DR:Chen Quan Long	DATE:23/02/11
.XXX: ± 0.01	.XX°: ± 1.0°	CHKD: Wu Hui	DATE:23/02/11
FINISH:		APPD:Ren An De	DATE:23/02/11
DRAWING NO: GC-DL20040-XXY-XXX-XX		UNITS: mm	REV.: A

REV.	REVISION DESCRIPTION	DATE	APPD

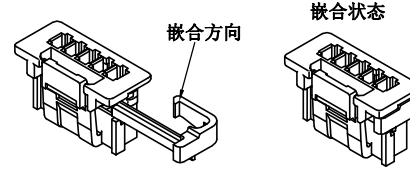
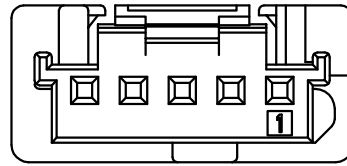

NOTES

Available in 02 through 15 Circuits.
Match with DL20040-AB/DL20040-AWB series housing

Material : PBT UL94V-0(2).

Accepts DL20062-T Crimp Terminal.

2PIN

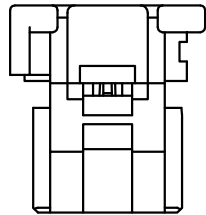

5-15PIN

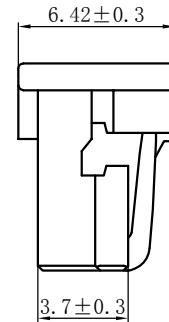
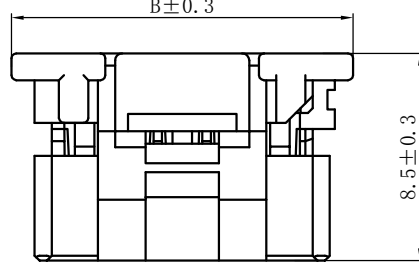

3-4PIN

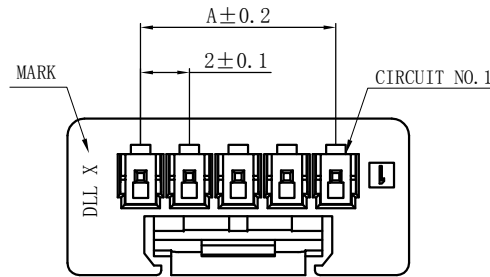
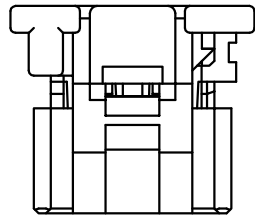

ORDERING INFORMATION

DL20062 - XX Y - X XX - XX
1 2 3 4 5 6

- PART NO.
- NO. OF CIRCUIT
- CONN. TYPE
- MATERIAL: 0:PA66 V0 1:PA66 V1 2:PA66 V2
3:PA66 V0 750°C 4:LCP 5:PBT
6:PA9T 7:PA6T 8:GF PA66
- COLOR: NA:NATURE RE:RED BR:BROWN
GY:GREY BK:BLACK YE:YELLOW
BL:BLUE GR:GREEN PU:PURPLE PI:PINK
OR:ORANGE TR:TRANSPARENT OT:OTHER
- SERIAL NUMBER: 00.01.02.....

Circuits	Product name	Dimension mm		Circuits	Product name	Dimension mm	
		A	B			A	B
2	PHM-2Y-SG	2.00	8.00	9	PHM-9Y-SG	16.00	22.00
3	PHM-3Y-SG	4.00	10.00	10	PHM-10Y-SG	18.00	24.00
4	PHM-4Y-SG	6.00	12.00	11	PHM-11Y-SG	20.00	26.00
5	PHM-5Y-SG	8.00	14.00	12	PHM-12Y-SG	22.00	28.00
6	PHM-6Y-SG	10.00	16.00	13	PHM-13Y-SG	24.00	30.00
7	PHM-7Y-SG	12.00	18.00	14	PHM-14Y-SG	26.00	32.00
8	PHM-8Y-SG	14.00	20.00	15	PHM-15Y-SG	28.00	34.00

GENERAL TOLERANCES (UNLESS SPECIFIED)		ZHE JIANG DELI CONNECTORS CO., LTD	
.X: ± 0.25	X°: ± 3.0°	PRODUCT NAME: DL20062-Y-SG (PHM-Y-SG)	TITLE: 2.00 mm Pitch Housing
.XX: ± 0.15	.X°: ± 2.0°	DR:Yuan Jun Jong	DATE:23/02/11
.XXX: ± 0.01	.XX°: ± 1.0°	CHKD: Wu Hui	DATE:23/02/11
FINISH:		APPD:Ren An De	DATE:23/02/11
DRAWING NO:			SCALE: N/A
			PAGE: 1/1
			UNITS: mm
			REV.: A

REV.	REVISION DESCRIPTION	DATE	APPD

NOTES

Available in 02 through 15 Circuits.
 Match with DL20062-Y-SG series housing
 Material : PBT UL94V-0.

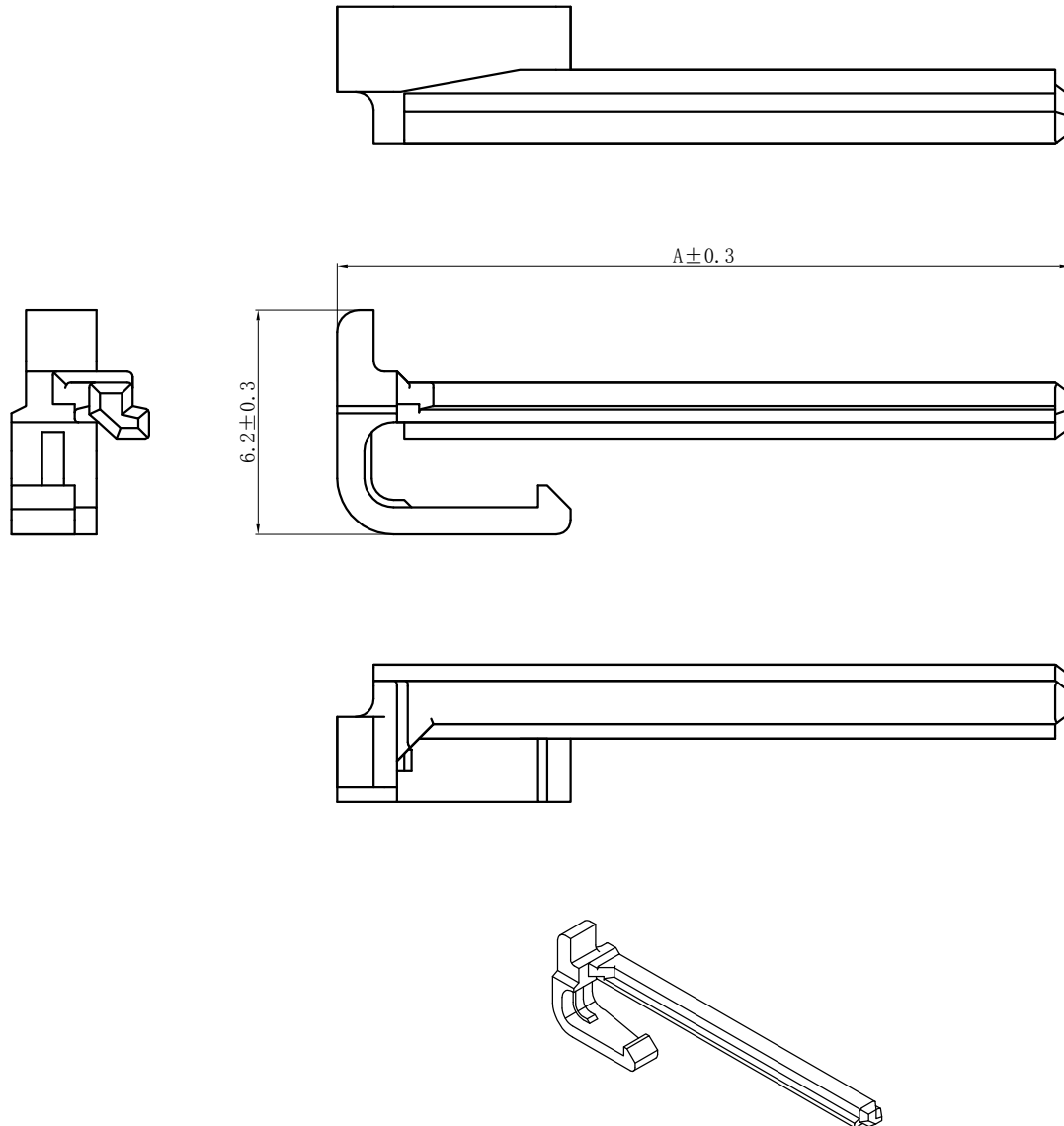

Circuits	Product name	Dimensino (mm)		Circuits	Product name	Dimensino (mm)	
		A				A	
2	PHM-2SG	6.25		9	PHM-9SG	20.25	
3	PHM-3SG	8.25		10	PHM-10SG	22.25	
4	PHM-4SG	10.25		11	PHM-11SG	24.25	
5	PHM-5SG	12.25		12	PHM-12SG	26.25	
6	PHM-6SG	14.25		13	PHM-13SG	28.25	
7	PHM-7SG	16.25		14	PHM-14SG	30.25	
8	PHM-8SG	18.25		15	PHM-15SG	32.25	

GENERAL TOLERANCES (UNLESS SPECIFIED)		ZHE JIANG DELI CONNECTORS CO., LTD			
.X: ± 0.25	X°: ± 3.0°	PRODUCT NAME: DL20062-SG (PHM-SG)		TITLE: 2.00 mm Pitch Housing	
.XX: ± 0.15	.X°: ± 2.0°	DR: Yuan Jun Rong	DATE: 24.04.06	PART NO:	
.XXX: ± 0.01	.XX°: ± 1.0°	CHKD: Wu Hui	DATE: 24.04.06	SCALE: N/A	PAGE: 1/1
DRAWING NO:		APPD: Ren An De	DATE: 24.04.06	UNITS: mm	REV.: A

REV.	REVISION DESCRIPTION	DATE	APPD

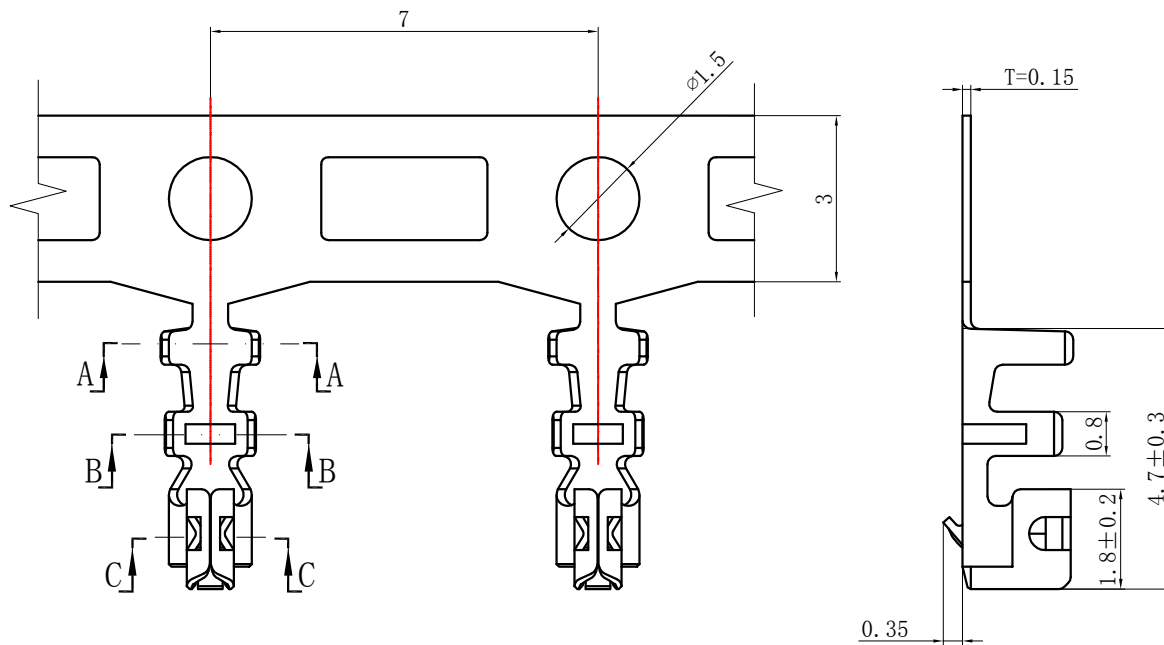

NOTES

Used in DL20040-Y Series Housing.
 Accepts AWG #30~24 Wire Range.
 Material : Phosphor Bronze .
 Finish: Tin plated.
 Thickness: 0.15 mm.

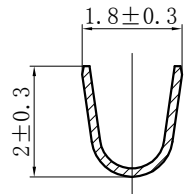

SECTION A-A

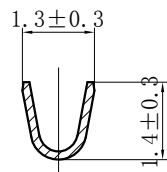

SECTION B-B

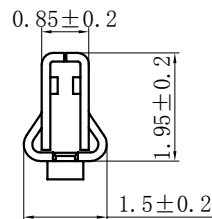

SECTION C-C

GENERAL TOLERANCES (UNLESS SPECIFIED)		ZHE JIANG DELI CONNECTORS CO., LTD	
.X: ± 0.25	X°: $\pm 3.0^\circ$	PRODUCT NAME: DL20040 (PHM)-T-D	TITLE: 2.00 mm Pitch Crimp Terminal
.XX: ± 0.15	.X°: $\pm 2.0^\circ$	DR: Chen Quan Long	DATE: 23/02/11
.XXX: ± 0.01	.XX°: $\pm 1.0^\circ$	CHKD: Wu Hui	DATE: 23/02/11
DRAWING NO:		APPD: Ren An De	DATE: 23/02/11
		SCALE: N/A	PAGE: 1/1
		UNITS: mm	REV.: A

REV.	REVISION DESCRIPTION	DATE	APPD

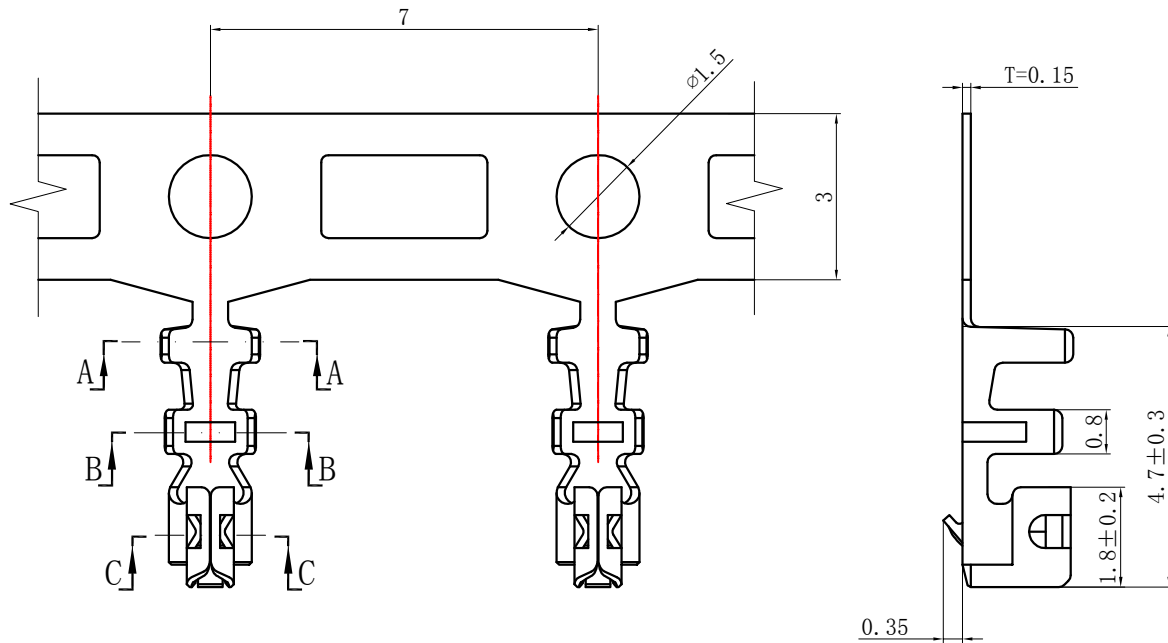

NOTES

Used in DL20040-Y Series Housing.
 Accepts AWG #26~22 Wire Range.
 Material : Phosphor Bronze .
 Finish: Tin plated.
 Thickness: 0.15 mm.

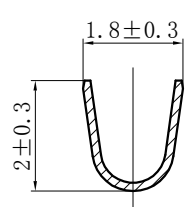

SECTION A-A

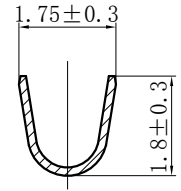

SECTION B-B

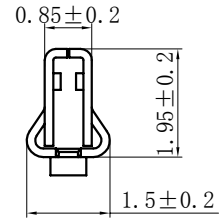

SECTION C-C

GENERAL TOLERANCES (UNLESS SPECIFIED)		ZHE JIANG DELI CONNECTORS CO., LTD	
.X: ± 0.25	X°: ± 3.0°	PRODUCT NAME:	TITLE: 2.00 mm Pitch Crimp Terminal
.XX: ± 0.15	.X°: ± 2.0°	DL20040 (PHM)-T-G	
.XXX: ± 0.01	.XX°: ± 1.0°	DR: Chen Quan Long	DATE: 23/02/11
FINISH:		CHKD: Wu Hui	DATE: 23/02/11
DRAWING NO:		APPD: Ren An De	DATE: 23/02/11
		SCALE: N/A	PAGE: 1/1
		UNITS: mm	REV.: A

REV.	REVISION DESCRIPTION	DATE	APPD

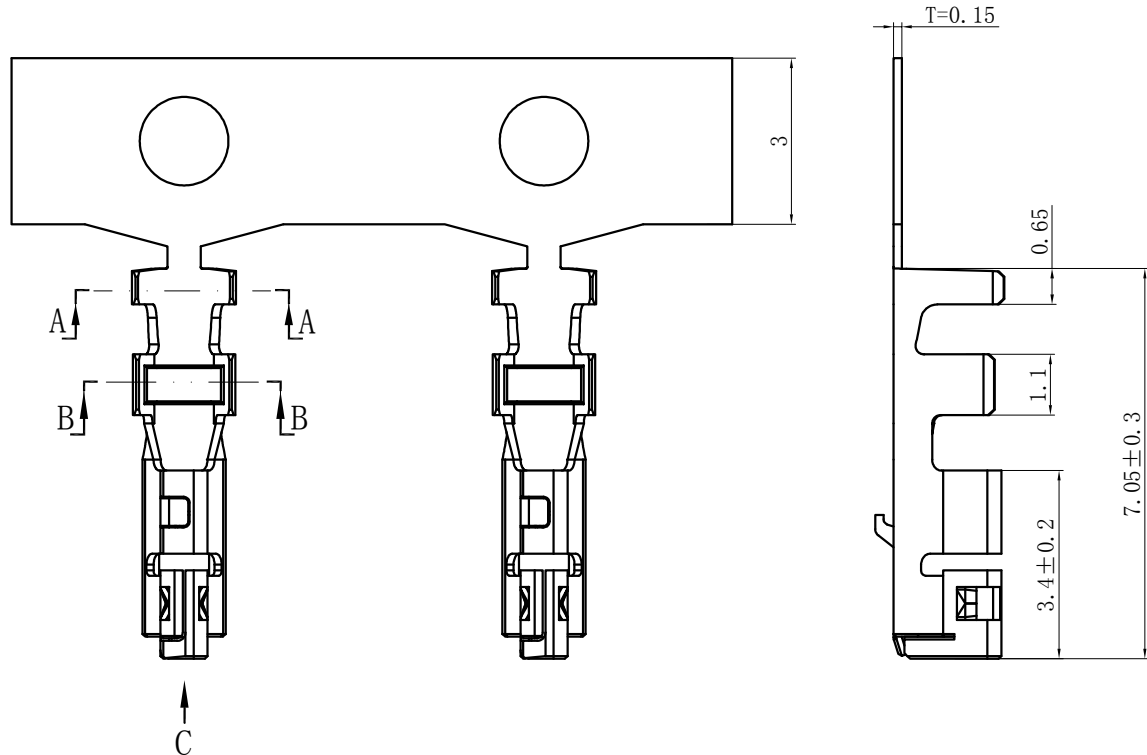

NOTES

Used in DL20062-Y-SG Series Housing.
 Accepts AWG #26~22 Wire Range.
 Material : Phosphor Bronze .
 Finish: Tin plated.
 Thickness: 0.15 mm.

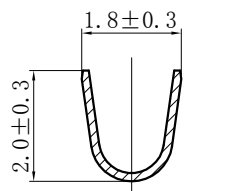

SECTION A-A

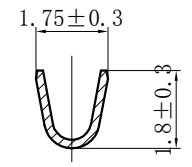

SECTION B-B

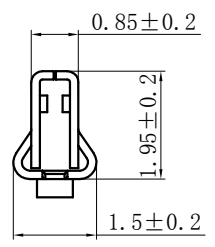

SECTION C

GENERAL TOLERANCES (UNLESS SPECIFIED)		ZHE JIANG DELI CONNECTORS CO., LTD	
.X: ± 0.25	X° : ± 3.0°	PRODUCT NAME:	TITLE: 2.00 mm Pitch Crimp Terminal
.XX: ± 0.15	.X° : ± 2.0°	DL20040-T-SG (PHM-T-SG)	PART NO:
.XXX: ± 0.01	.XX° : ± 1.0°	DR: Chen Quan Long	DATE: 23/02/11
FINISH:		CHKD: Wu Hui	DATE: 23/02/11
DRAWING NO:		APPD: Ren An De	DATE: 23/02/11
		SCALE: N/A	PAGE: 1/1
		UNITS: mm	REV.: A