

Features

- High Breakdown Voltage
- Low Turn-on Voltage
- Guard Ring Construction for Transient Protection

SOD-123
Absolute Maximum Ratings Ta = 25 °C

Parameter	Symbol	Rating	Unit
Peak Repetitive Reverse Voltage	VRRM	100	V
Working Peak Reverse Voltage	VRWM		
DC Blocking Voltage	VR		
Forward Current	IF	150	mA
Peak Forward Surge Current@ tp < 1.0s, Duty Cycle < 50% (Note.1)	IFM	350	
Forward Surge Forward Current @ tp=10ms (Note.1)	IFSM	750	
Power Dissipation	Pd	200	mW
Thermal Resistance Junction to Ambient	RθJA	420	°C/W
		370	
Junction Temperature	TJ	150	°C
Storage Temperature range	Tstg	-55 to 150	

Note.1: Part mounted on FR-4 board with recommended pad layout

Note.2: Part mounted on Polyimide board with recommended pad layout

Electrical Characteristics Ta = 25 °C

Parameter	Symbol	Test Conditions	Min	Typ	Max	Unit
Reverse breakdown voltage	VR	IR= 100 uA	100			V
Forward voltage	VF	IF= 0.1 mA			0.25	
		IF= 10 mA			0.45	
		IF= 250 mA			1	
Reverse voltage leakage current	IR1	VR= 1.5 V			0.3	uA
	IR2	VR= 10 V			0.5	
	IR3	VR= 50 V			1	
	IR4	VR= 75 V			2	
Total capacitance	CT	VR= 0 V, f= 1 MHz		20		pF
		VR= 1 V, f= 1 MHz		12		

Typical Characteristics

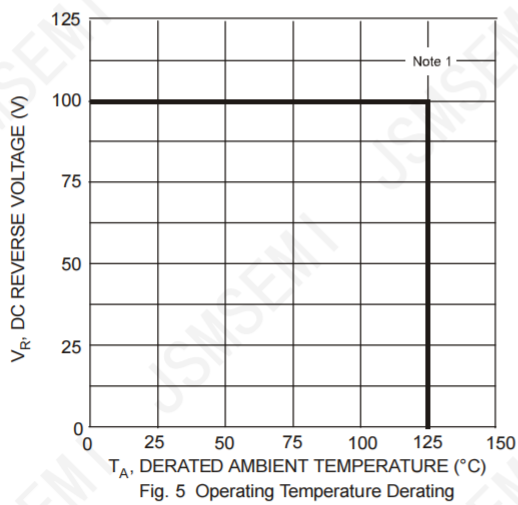
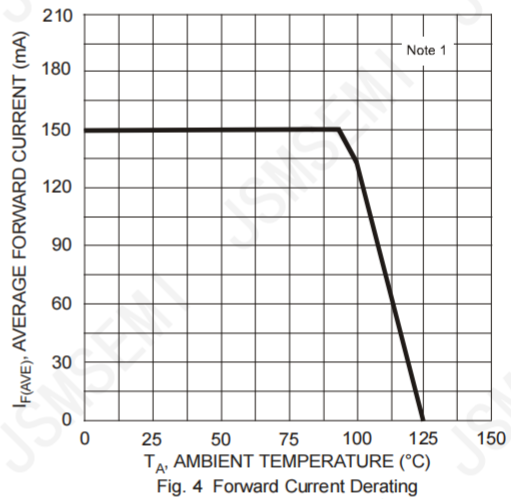
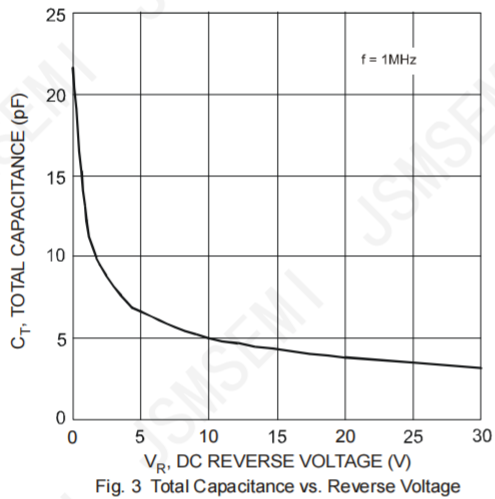
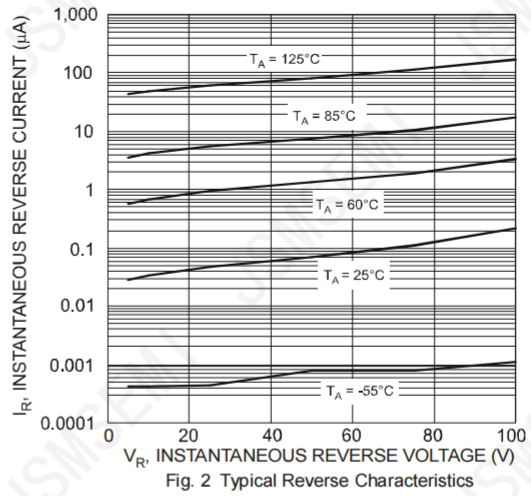
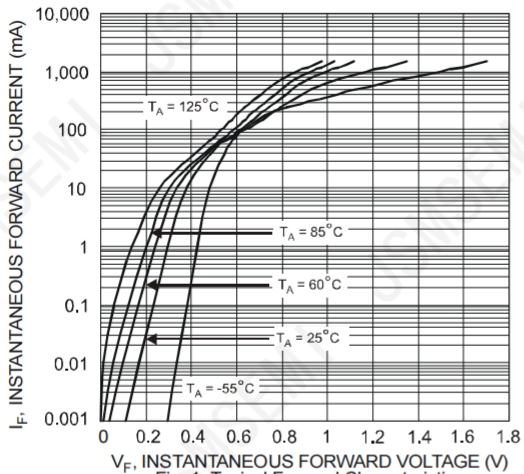

SOD-123

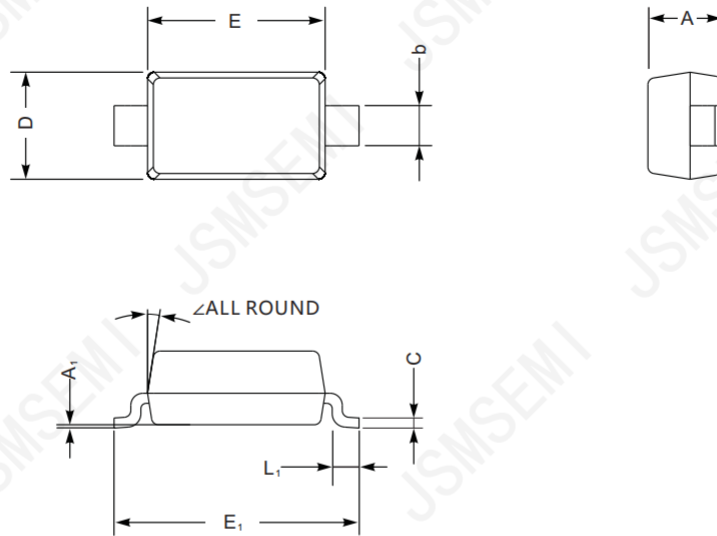

SOD-123 mechanical data

UNIT		A	C	D	E	E ₁	L ₁	b	A ₁	∠
mm	max	1.3	0.22	1.8	2.8	3.9	0.45	0.7	0.2	9°
	min	0.9	0.09	1.5	2.5	3.6	0.25	0.5	—	
mil	max	51	8.7	71	110	154	18	28	8	
	min	35	3.5	59	98	142	10	20	—	

The recommended mounting pad size

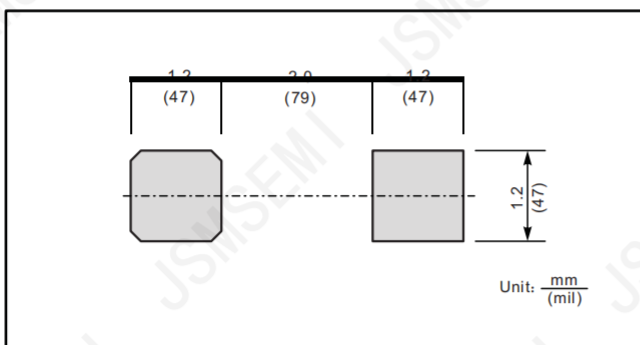

Revision History

Rev.	Change	Date
V1.0	Initial version	2/23/2024

Important Notice

JSMSEMI Semiconductor (JSMSEMI) PRODUCTS ARE NEITHER DESIGNED NOR INTENDED FOR USE IN MILITARY AND/OR AEROSPACE, AUTOMOTIVE OR MEDICAL DEVICES OR SYSTEMS UNLESS THE SPECIFIC JSMSEMI PRODUCTS ARE SPECIFICALLY DESIGNATED BY JSMSEMI FOR SUCH USE. BUYERS ACKNOWLEDGE AND AGREE THAT ANY SUCH USE OF JSMSEMI PRODUCTS WHICH JSMSEMI HAS NOT DESIGNATED FOR USE IN MILITARY AND/OR AEROSPACE, AUTOMOTIVE OR MEDICAL DEVICES OR SYSTEMS IS SOLELY AT THE BUYER' S RISK.

JSMSEMI assumes no liability for application assistance or customer product design. Customers are responsible for their products and applications using JSMSEMI products.

Resale of JSMSEMI products or services with statements diferent from or beyond the parameters stated by JSMSEMI for that product or service voids all express and any implied warranties for the associated JSMSEMI product or s ervice. JSMSEMI is not responsible or liable for any such statements.

JSMSEMI All Rights Reserved. Information and data in this document are owned by JSMSEMI wholly and may not be edited, reproduced, or redistributed in any way without the express written consent from JSMSEMI.

Any and all information described or contained herein are subject to change without notice due to product/technology improvement, etc. When designing equipment, refer to the "Delivery Specification" for the JSMSEMI product that you intend to use.

For additional information please contact Kevin@jsmsemi.com or visit www.jsmsemi.com