

64 Mbit (4M x 16) Static RAM

Features

- Very High Speed
 - 55 ns
- Wide Voltage Range
 - 2.2V to 3.7V
- Ultra Low Standby Power
 - Typical Standby Current: 8 μA
 - Maximum Standby Current: 48 μA
- Ultra Low Active Power
 - Typical Active Current: 4.0 mA at f = 1 MHz
- Easy Memory Expansion with \overline{CE}_1 , CE_2 , and \overline{OE} Features
- Automatic Power Down when Deselected
- CMOS for Optimum Speed and Power
- Available in Pb-Free 48-Ball FBGA Package

Functional Description

The CY62187EV30 is a high performance CMOS static RAM organized as 4M words by 16 bits^[1]. This device features advanced circuit design to provide ultra low active current. It is

ideal for providing More Battery Life™ (MoBL®) in portable applications such as cellular telephones. The device also has an automatic power down feature that significantly reduces power consumption by 99 percent when addresses are not toggling. The device can also be put into standby mode when deselected (\overline{CE}_1 HIGH or CE_2 LOW or both \overline{BHE} and \overline{BLE} are HIGH). The input and output pins (IO_0 through IO_{15}) are placed in a high impedance state when: deselected (\overline{CE}_1 HIGH or CE_2 LOW), outputs are disabled (\overline{OE} HIGH), both \overline{Byte} High Enable and \overline{Byte} Low Enable are disabled (\overline{BHE} , \overline{BLE} HIGH), or during a write operation (\overline{CE}_1 LOW, CE_2 HIGH and \overline{WE} LOW).

To write to the device, take \overline{Chip} Enables (\overline{CE}_1 LOW and CE_2 HIGH) and Write Enable (\overline{WE}) input LOW. If \overline{Byte} Low Enable (\overline{BLE}) is LOW, then data from I/O pins (IO_0 through IO_7), is written into the location specified on the address pins (A_0 through A_{21}). If \overline{Byte} High Enable (\overline{BHE}) is LOW, then data from I/O pins (IO_8 through IO_{15}) is written into the location specified on the address pins (A_0 through A_{21}).

To read from the device, take \overline{Chip} Enables (\overline{CE}_1 LOW and CE_2 HIGH) and Output Enable (\overline{OE}) LOW while forcing the Write Enable (\overline{WE}) HIGH. If \overline{Byte} Low Enable (\overline{BLE}) is LOW, then data from the memory location specified by the address pins appear on IO_0 to IO_7 . If \overline{Byte} High Enable (\overline{BHE}) is LOW, then data from memory appears on IO_8 to IO_{15} . See the [Truth Table](#) on page 9 for a complete description of read and write modes.

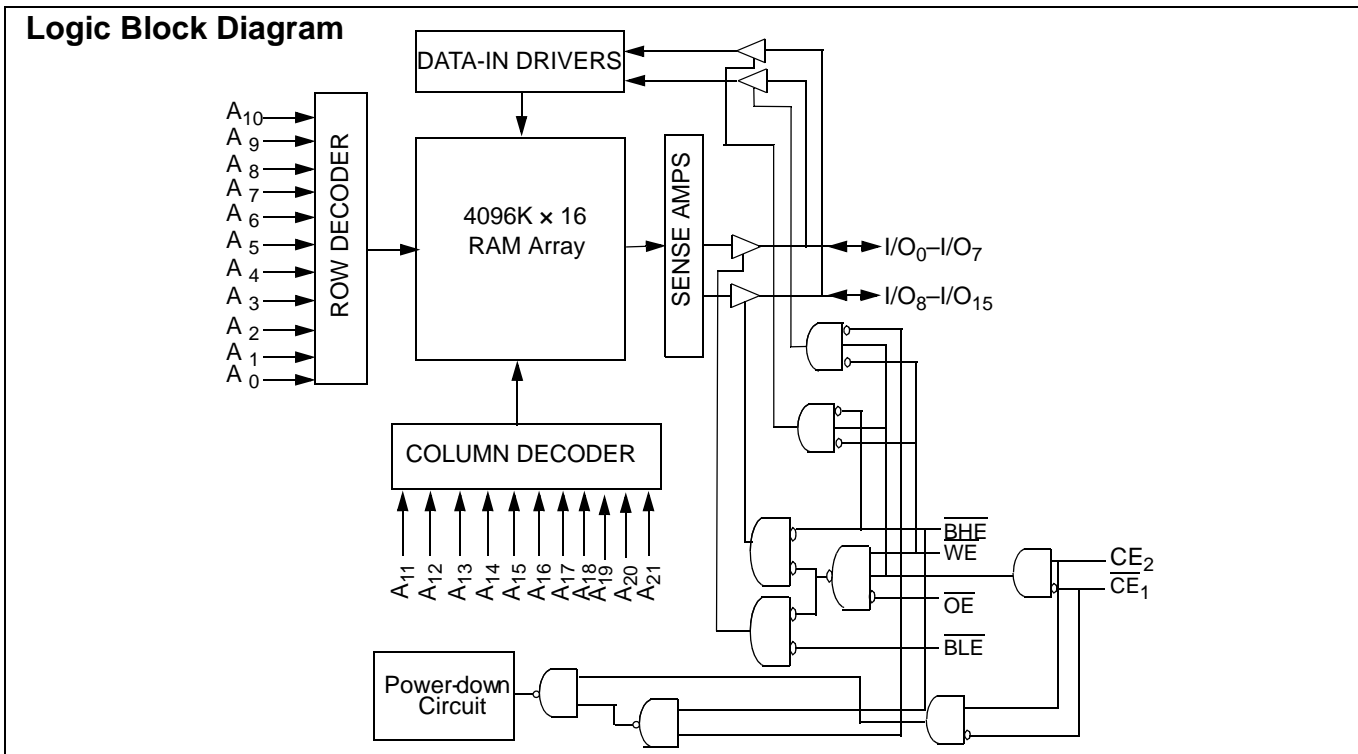

Note

1. For best practice recommendations, refer to the Cypress application note "System Design Guidelines" on <http://www.cypress.com>.

Pin Configuration

Figure 1. 48-Ball VFBGA

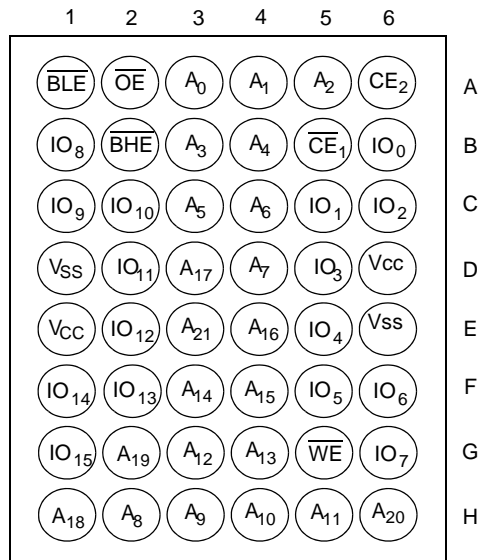

Product Portfolio

Product	V _{CC} Range (V)			Speed (ns)	Power Dissipation					
					Operating I _{CC} (mA)				Standby I _{SB2} (µA)	
					f = 1 MHz		f = f _{Max}			
Min	Typ ^[2]	Max	Typ ^[2]	Max	Typ ^[2]	Max	Typ ^[2]	Max		
CY62187EV30LL	2.2	3.0	3.7	55	4.0	6	45	55	8	48
				70	4.0	6	35	45	8	48

Note

2. Typical values are included for reference only and are not guaranteed or tested. Typical values are measured at V_{CC} = V_{CC(typ)}, T_A = 25°C.

Maximum Ratings

Exceeding maximum ratings may impair the useful life of the device. These user guidelines are not tested.

- Storage Temperature -65°C to + 150°C
- Ambient Temperature with Power Applied -55°C to + 125°C
- Supply Voltage to Ground Potential..... -0.3V to $V_{CC(max)}$ + 0.3V
- DC Voltage Applied to Outputs in High Z State ^[3, 4]..... -0.3V to $V_{CC(max)}$ + 0.3V

- DC Input Voltage ^[3, 4] -0.3V to $V_{CC(max)}$ + 0.3V
- Output Current into Outputs (LOW) 20 mA
- Static Discharge Voltage..... >2001V (per MIL-STD-883, Method 3015)
- Latch Up Current >200 mA

Operating Range

Device	Range	Ambient Temperature	V_{CC} ^[5]
CY62187EV30LL	Industrial	-40°C to +85°C	2.2V to 3.7V

Electrical Characteristics

Over the Operating Range

Parameter	Description	Test Conditions	55 ns			70 ns			Unit	
			Min	Typ ^[2]	Max	Min	Typ ^[2]	Max		
V _{OH}	Output HIGH Voltage	$2.2V \leq V_{CC} \leq 2.7V$	$I_{OH} = -0.1 \text{ mA}$		2.0			2.0		V
		$2.7V \leq V_{CC} \leq 3.7V$	$I_{OH} = -1.0 \text{ mA}$		2.4			2.4		V
V _{OL}	Output LOW Voltage	$2.2V \leq V_{CC} \leq 2.7V$	$I_{OL} = 0.1 \text{ mA}$				0.4		0.4	V
		$2.7V \leq V_{CC} \leq 3.7V$	$I_{OL} = 2.1 \text{ mA}$				0.4		0.4	V
V _{IH}	Input HIGH Voltage	$2.2V \leq V_{CC} \leq 2.7V$		1.8		$V_{CC} + 0.3V$	1.8		$V_{CC} + 0.3V$	V
		$2.7V \leq V_{CC} \leq 3.7V$		2.2		$V_{CC} + 0.3V$	2.2		$V_{CC} + 0.3V$	V
V _{IL}	Input LOW Voltage	$2.2V \leq V_{CC} \leq 2.7V$		-0.3		0.6	-0.3		0.6	V
		$2.7V \leq V_{CC} \leq 3.7V$		-0.3		0.7	-0.3		0.7	V
I _{IX}	Input Leakage Current	$GND \leq V_I \leq V_{CC}$		-1		+1	-1		+1	μA
I _{OZ}	Output Leakage Current	$GND \leq V_O \leq V_{CC}$, Output Disabled		-1		+1	-1		+1	μA
I _{CC}	V _{CC} Operating Supply Current	$f = f_{Max} = 1/t_{RC}$	$V_{CC} = V_{CC(max)}$ $I_{OUT} = 0 \text{ mA}$ CMOS levels		45	55		35	45	mA
		$f = 1 \text{ MHz}$			4.0	6		4.0	6	mA
I _{SB2} ^[6]	Automatic CE Power-Down Current—CMOS Inputs	$CE_1 \geq V_{CC} - 0.2V$ or $CE_2 \leq 0.2V$, $V_{IN} \geq V_{CC} - 0.2V$ or $V_{IN} \leq 0.2V$, $f = 0$, $V_{CC} = 3.7V$			8	48		8	48	μA

Capacitance

Tested initially and after any design or process changes that may affect these parameters.

Parameter	Description	Test Conditions	Max	Unit
C _{IN}	Input Capacitance	$T_A = 25^\circ\text{C}$, $f = 1 \text{ MHz}$, $V_{CC} = V_{CC(typ)}$	25	pF
C _{OUT}	Output Capacitance		35	pF

Notes

3. $V_{IL(min)}$ = -2.0V for pulse durations less than 20 ns.
4. $V_{IH(max)}$ = $V_{CC} + 0.75V$ for pulse durations less than 20 ns.
5. Full Device AC operation assumes a 100 μs ramp time from 0 to V_{CC} (min) and 200 μs wait time after V_{CC} stabilization.
6. Only chip enables (CE_1 and CE_2) need to be tied to CMOS levels to meet the I_{SB2} / I_{CCDR} spec. Other inputs can be left floating.

Thermal Resistance

Tested initially and after any design or process changes that may affect these parameters.

Parameter	Description	Test Conditions	FBGA	Unit
Θ_{JA}	Thermal Resistance (Junction to Ambient)	Still Air, soldered on a 3 x 4.5 inch, 2-layer printed circuit board	59.06	$^{\circ}\text{C}/\text{W}$
Θ_{JC}	Thermal Resistance (Junction to Case)		14.08	$^{\circ}\text{C}/\text{W}$

Figure 2. AC Test Loads and Waveforms

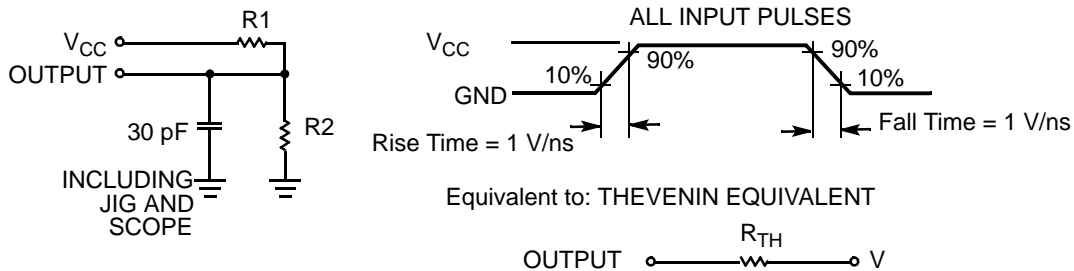

Table 1. AC Test Loads

Parameter	2.2V to 3.7V	Unit
R1	1103	Ω
R2	1554	Ω
R_{TH}	645	Ω
V_{TH}	$2.2\text{V} < V_{CC} \leq 3\text{V}$	$V_{CC}/2$
	$3\text{V} < V_{CC} \leq 3.7\text{V}$	1.5

Data Retention Characteristics

Over the Operating Range

Parameter	Description	Conditions	Min	Typ ^[2]	Max	Unit
V_{DR}	V_{CC} for Data Retention		1.5			V
I_{CCDR} ^[6]	Data Retention Current	$V_{CC} = 1.5\text{V}$, $\overline{CE}_1 \geq V_{CC} - 0.2\text{V}$, $CE_2 \leq 0.2\text{V}$, $V_{IN} \geq V_{CC} - 0.2\text{V}$ or $V_{IN} \leq 0.2\text{V}$			48	μA
t_{CDR} ^[7]	Chip Deselect to Data Retention Time		0			ns
t_R ^[8]	Operation Recovery Time		t_{RC}			ns

Figure 3. Data Retention Waveform ^[9]

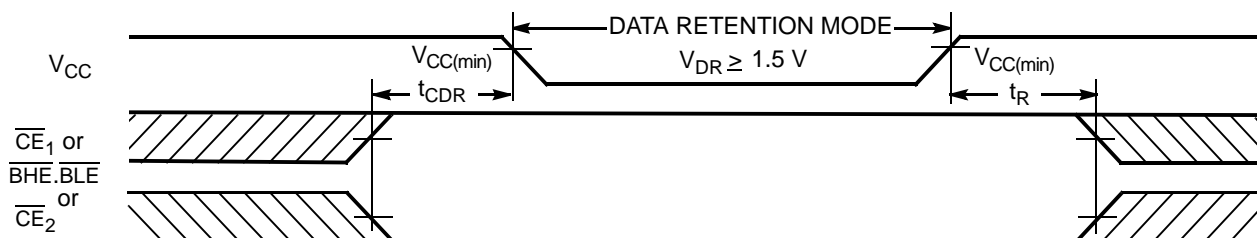

Notes

7. Tested initially and after any design or process changes that may affect these parameters.
8. Full device operation requires linear V_{CC} ramp from V_{DR} to $V_{CC(\text{min})} \geq 100 \mu\text{s}$ or stable at $V_{CC(\text{min})} \geq 100 \mu\text{s}$.
9. $\overline{BHE.BLE}$ is the AND of both \overline{BHE} and \overline{BLE} . Chip is deselected by either disabling the chip enable signals or by disabling both \overline{BHE} and \overline{BLE} .

Switching Characteristics

Over the Operating Range ^[10]

Parameter	Description	55 ns		70 ns		Unit
		Min	Max	Min	Max	
Read Cycle						
t _{RC}	Read Cycle Time	55		70		ns
t _{AA}	Address to Data Valid		55		70	ns
t _{OHA}	Data Hold from Address Change	6		6		ns
t _{ACE}	CE ₁ LOW and CE ₂ HIGH to Data Valid		55		70	ns
t _{DOE}	OE LOW to Data Valid		25		35	ns
t _{LZOE}	OE LOW to Low Z ^[11]	5		5		ns
t _{HZOE}	OE HIGH to High Z ^[11, 12]		20		25	ns
t _{LZCE}	CE ₁ LOW and CE ₂ HIGH to Low Z ^[11]	10		10		ns
t _{HZCE}	CE ₁ HIGH and CE ₂ LOW to High Z ^[11, 12]		20		25	ns
t _{PU}	CE ₁ LOW and CE ₂ HIGH to Power Up	0		0		ns
t _{PD}	CE ₁ HIGH and CE ₂ LOW to Power Down		55		70	ns
t _{DBE}	BLE/BHE LOW to Data Valid		55		70	ns
t _{LZBE}	BLE/BHE LOW to Low Z ^[11]	10		10		ns
t _{HZBE}	BLE/BHE HIGH to HIGH Z ^[11, 12]		20		25	ns
Write Cycle^[13]						
t _{WC}	Write Cycle Time	55		70		ns
t _{SCE}	CE ₁ LOW and CE ₂ HIGH to Write End	45		60		ns
t _{AW}	Address Setup to Write End	45		60		ns
t _{HA}	Address Hold from Write End	0		0		ns
t _{SA}	Address Setup to Write Start	0		0		ns
t _{PWE}	WE Pulse Width	40		50		ns
t _{BW}	BLE/BHE LOW to Write End	45		60		ns
t _{SD}	Data Setup to Write End	25		35		ns
t _{HD}	Data Hold from Write End	0		0		ns
t _{HZWE}	WE LOW to High-Z ^[11, 12]		20		25	ns
t _{LZWE}	WE HIGH to Low-Z ^[11]	10		10		ns

Notes

10. Test conditions for all parameters other than tri-state parameters assume signal transition time of 1V/ns, timing reference levels of V_{TH}, input pulse levels of 0 to V_{CC(typ)}, and output loading of the specified I_{OL}/I_{OH} as shown in [AC Test Loads](#) on page 4.
11. At any given temperature and voltage condition, t_{HZCE} is less than t_{LZCE}, t_{HZBE} is less than t_{LZBE}, t_{HZOE} is less than t_{LZOE}, and t_{HZWE} is less than t_{LZWE} for any given device.
12. t_{HZOE}, t_{HZCE}, t_{HZBE}, and t_{HZWE} transitions are measured when the outputs enter a high impedance state.
13. The internal Write time of the memory is defined by the overlap of WE, CE₁ = V_{IL}, BHE and/or BLE = V_{IL}, and CE₂ = V_{IH}. All signals must be ACTIVE to initiate a write and any of these signals can terminate a write by going INACTIVE. The data input setup and hold timing should be referenced to the edge of the signal that terminates the write.

Switching Waveforms

Figure 4. Read Cycle 1 (Address Transition Controlled)^[14, 15]

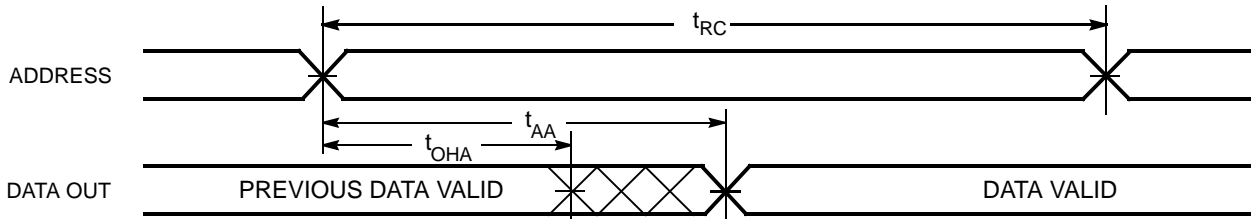
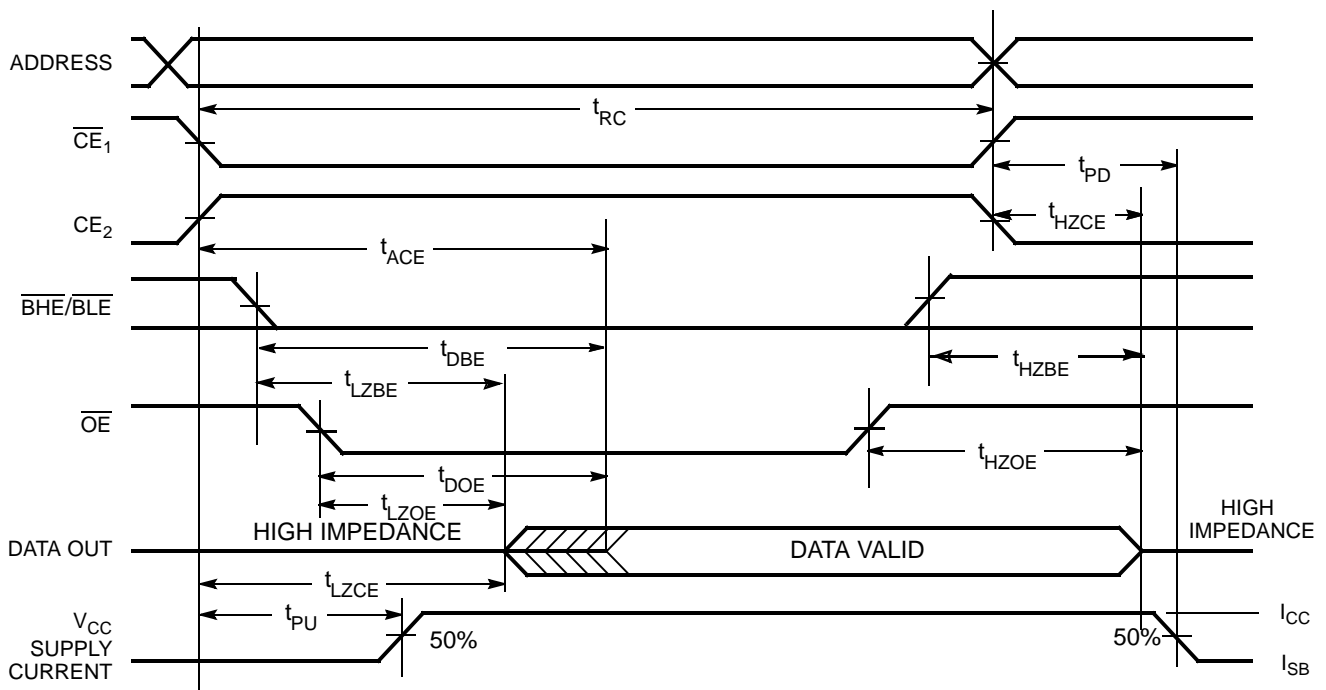

Figure 5. Read Cycle 2 (\overline{OE} Controlled)^[15, 16]



Notes

- 14. The device is continuously selected. \overline{OE} , $\overline{CE}_1 = V_{IL}$, \overline{BHE} and/or $\overline{BLE} = V_{IL}$, and $CE_2 = V_{IH}$.
- 15. \overline{WE} is HIGH for read cycle.
- 16. Address valid prior to or coincident with \overline{CE}_1 , \overline{BHE} , \overline{BLE} transition LOW and CE_2 transition HIGH.

Switching Waveforms (continued)

Figure 6. Write Cycle 1 (\overline{WE} Controlled) [13, 17, 18, 19]

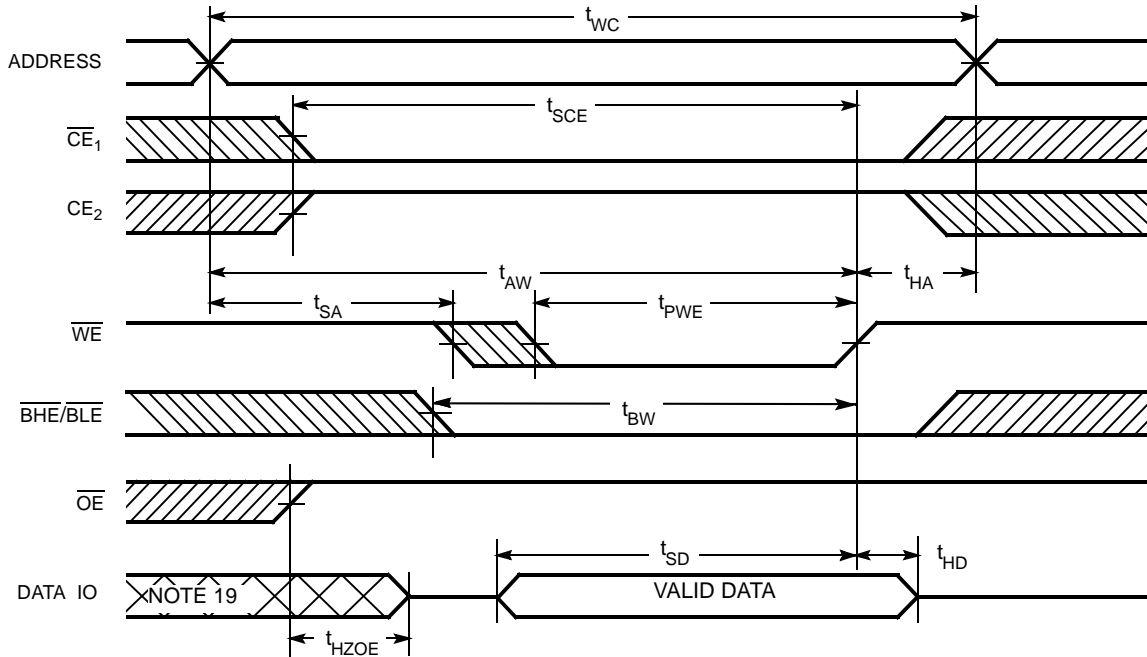
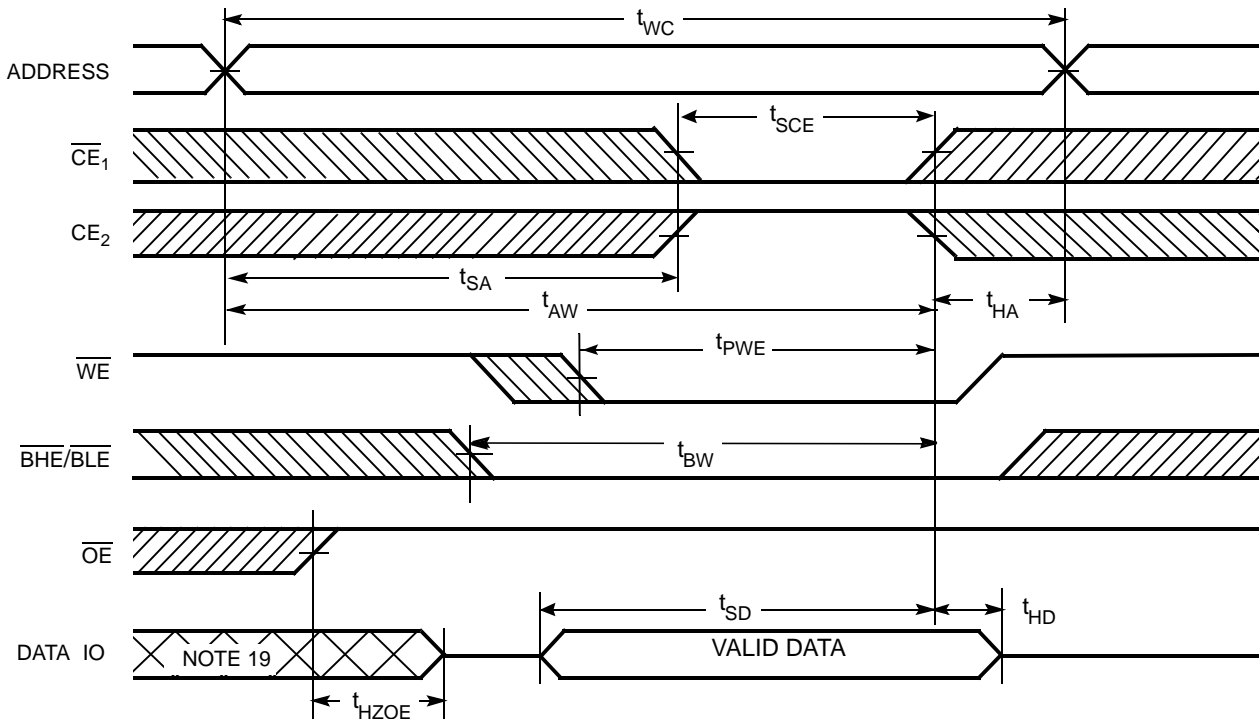

Figure 7. Write Cycle 2 (\overline{CE}_1 or CE_2 Controlled) [13, 17, 18, 19]



Notes

- 17. Data I/O is high impedance if $\overline{OE} = V_{IH}$.
- 18. If \overline{CE}_1 goes HIGH and CE_2 goes LOW simultaneously with $\overline{WE} = V_{IH}$, the output remains in a high impedance state.
- 19. During this period the I/Os are in output state and input signals should not be applied.

Switching Waveforms (continued)

Figure 8. Write Cycle 3 (\overline{WE} Controlled, \overline{OE} LOW)^[18, 19]

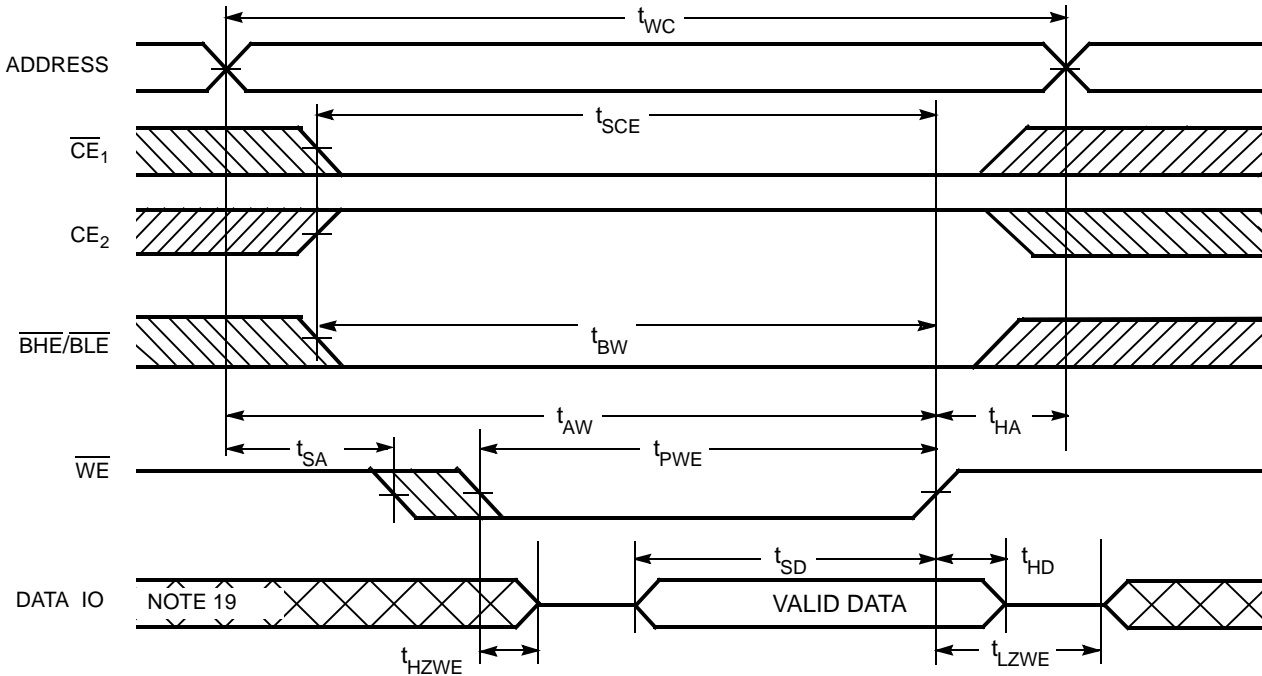
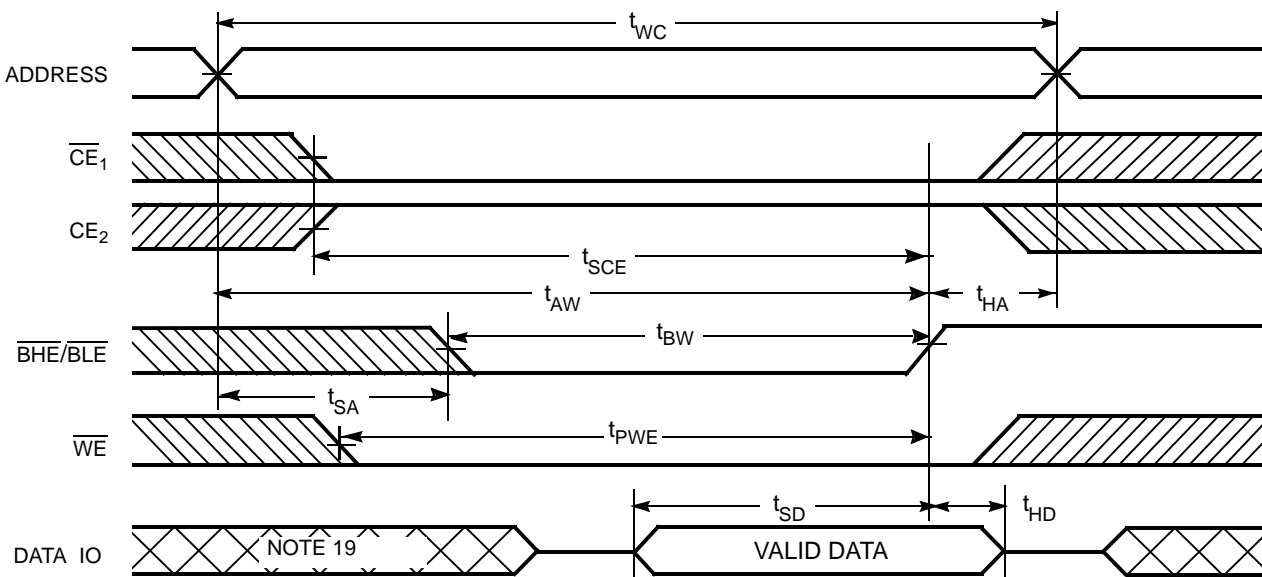

Figure 9. Write Cycle 4 ($\overline{BHE}/\overline{BLE}$ Controlled, \overline{OE} LOW)^[18, 19]



Truth Table

\overline{CE}_1	\overline{CE}_2	\overline{WE}	\overline{OE}	\overline{BHE}	\overline{BLE}	Inputs Outputs	Mode	Power
H	X ^[20]	X	X	X	X	High Z	Deselect/Power Down	Standby (I _{SB})
X ^[20]	L	X	X	X	X	High Z	Deselect/Power Down	Standby (I _{SB})
X ^[20]	X ^[20]	X	X	H	H	High Z	Deselect/Power Down	Standby (I _{SB})
L	H	H	L	L	L	Data Out (IO ₀ –IO ₁₅)	Read	Active (I _{CC})
L	H	H	L	H	L	High Z (IO ₈ –IO ₁₅); Data Out (IO ₀ –IO ₇)	Read	Active (I _{CC})
L	H	H	L	L	H	Data Out (IO ₈ –IO ₁₅); High Z (IO ₀ –IO ₇)	Read	Active (I _{CC})
L	H	L	X	L	L	Data In (IO ₀ –IO ₁₅)	Write	Active (I _{CC})
L	H	L	X	H	L	High Z (IO ₈ –IO ₁₅); Data In (IO ₀ –IO ₇)	Write	Active (I _{CC})
L	H	L	X	L	H	Data In (IO ₈ –IO ₁₅); High Z (IO ₀ –IO ₇)	Write	Active (I _{CC})
L	H	H	H	L	H	High Z	Output Disabled	Active (I _{CC})
L	H	H	H	H	L	High Z	Output Disabled	Active (I _{CC})
L	H	H	H	L	L	High Z	Output Disabled	Active (I _{CC})

Ordering Information

Speed (ns)	Ordering Code	Package Diagram	Package Type	Operating Range
55	CY62187EV30LL-55BAXI	001-50044	48-Ball Fine Pitch Ball Grid Array (8 x 9.5 x 1.4 mm) Pb-Free	Industrial
70	CY62187EV30LL-70BAXI	001-50044	48-Ball Fine Pitch Ball Grid Array (8 x 9.5 x 1.4 mm) Pb-Free	Industrial

Note

20. The 'X' (Don't care) state for the chip enables in the truth table refer to the logic state (either HIGH or LOW). Intermediate voltage levels on these pins is not permitted.

Package Diagrams

Figure 10. 48-Ball FBGA (8 x 9.5 x 1.4 mm) (001-50044)

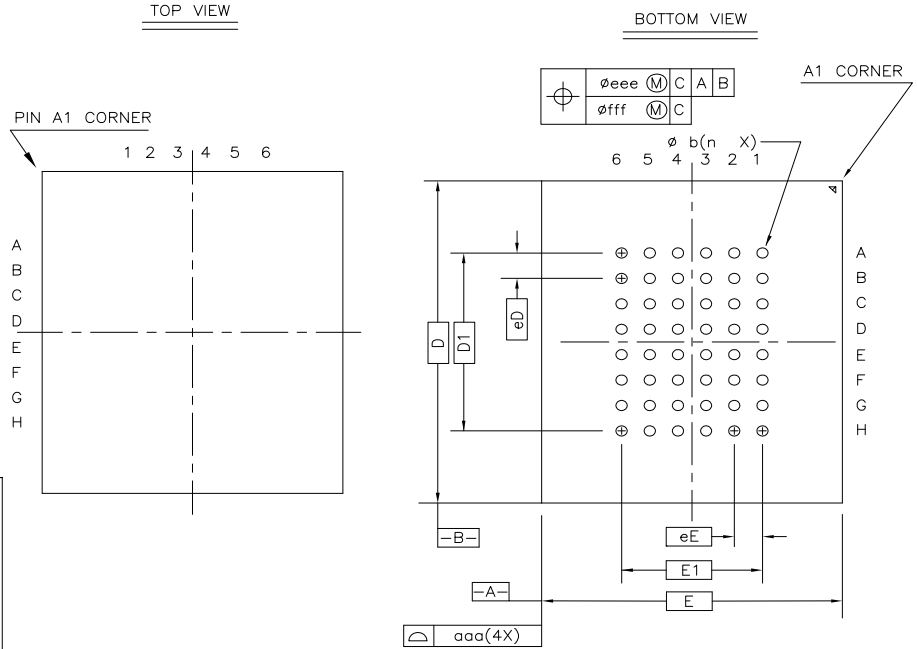

- NOTES :
1. JEDEC REFERENCE MO-205
 2. PACKAGE WEIGHT : 0.2409g
 3. DIMENSIONS IN MILLIMETERS

	Symbol	Common Dimensions
Package :		FBGA
Body Size :	X	E 8.00
	Y	D 9.50
Ball Pitch :	X	eE 0.75
	Y	eD 0.75
Total Thickness :	A	1.45 +/- 0.05
Mold Thickness :	M	0.910 Ref.
Substrate Thickness :	S	0.21 Ref.
Ball Diameter :		0.30
Stand Off :	A1	0.16-0.26
Ball Width :	b	0.27-0.37
Package Edge Tolerance :	aaa	0.150
Mold Flatness :	bbb	0.200
Coplanarity:	ddd	0.080
Ball Offset (Package) :	eee	0.150
Ball Offset (Ball) :	fff	0.080
Ball Count :	n	48
Edge Ball Center to Center :	X	E1 3.750
	Y	D1 5.250

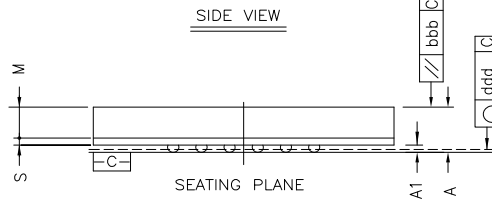

001-50044 - *A

Document History Page

Document Title: CY62187EV30 MoBL [®] 64 Mbit (4M x 16) Static RAM				
Document Number: 001-48998				
Rev.	ECN No.	Orig. of Change	Submission Date	Description of Change
**	2595932	VKN/PYRS	10/24/08	New Data Sheet
*A	2644442	VKN/PYRS	01/23/09	Updated the Package diagram on page 10
*B	2672650	VKN/PYRS	03/12/09	<p>Extended the V_{CC} range to 3.7V</p> <p>Added 55 ns speed bin and it's related information</p> <p>Changed $I_{CC(typ)}$ from 2.5 mA to 3.5 mA at $f = 1$ MHz</p> <p>Changed $I_{CC(max)}$ from 4 mA to 6 mA at $f = 1$ MHz</p> <p>For 70 ns speed, changed $I_{CC(typ)}$ form 33 mA to 28 mA at $f = f_{MAX}$</p> <p>For 70 ns speed, changed $I_{CC(max)}$ from 40 mA to 45 mA at $f = f_{MAX}$</p> <p>For 70 ns speed, changed t_{PWE} from 45 to 50 ns, t_{SD} from 30 to 35 ns</p> <p>Modified footnote #6</p> <p>Changed 48-Ball FBGA package dimensions from 8 x 9.5 x 1.6 mm to 8 x 9.5 x 1.4 mm and updated package diagram on page 10</p>
*C	2737164	VKN/AESA	07/13/09	<p>Converted from preliminary to final</p> <p>Changed $I_{CC(typ)}$ from 3.5 mA to 4 mA at $f = 1$ MHz</p> <p>Changed $I_{CC(typ)}$ from 35 mA to 45 mA and from 28 mA to 35 mA for the speeds 50 ns and 70 ns respectively at $f = f_{max}$</p> <p>Included V_{CC} range in the test condition of the "Electrical Characteristics" table for the specs V_{OH}, V_{OL}, V_{IH}, V_{IL}</p> <p>Changed $V_{IL(max)}$ from 0.8V to 0.7V for $V_{CC} = 2.7V$ to 3.7V</p> <p>Changed C_{IN} spec from 20 pF to 25 pF and C_{OUT} spec from 20 pF to 35 pF</p> <p>Included thermal specs for 48-FBGA</p> <p>Included V_{CC} range for V_{TH} spec in the AC test load table</p> <p>Changed t_{LZBE} spec from 5 ns to 10 ns</p> <p>Added footnote #20 related to chip enable</p>

Sales, Solutions, and Legal Information

Worldwide Sales and Design Support

Cypress maintains a worldwide network of offices, solution centers, manufacturer's representatives, and distributors. To find the office closest to you, visit us at www.cypress.com/sales.

Products

PSoC	psoc.cypress.com
Clocks & Buffers	clocks.cypress.com
Wireless	wireless.cypress.com
Memories	memory.cypress.com
Image Sensors	image.cypress.com

© Cypress Semiconductor Corporation, 2008-2009. The information contained herein is subject to change without notice. Cypress Semiconductor Corporation assumes no responsibility for the use of any circuitry other than circuitry embodied in a Cypress product. Nor does it convey or imply any license under patent or other rights. Cypress products are not warranted nor intended to be used for medical, life support, life saving, critical control or safety applications, unless pursuant to an express written agreement with Cypress. Furthermore, Cypress does not authorize its products for use as critical components in life-support systems where a malfunction or failure may reasonably be expected to result in significant injury to the user. The inclusion of Cypress products in life-support systems application implies that the manufacturer assumes all risk of such use and in doing so indemnifies Cypress against all charges.

Any Source Code (software and/or firmware) is owned by Cypress Semiconductor Corporation (Cypress) and is protected by and subject to worldwide patent protection (United States and foreign), United States copyright laws and international treaty provisions. Cypress hereby grants to licensee a personal, non-exclusive, non-transferable license to copy, use, modify, create derivative works of, and compile the Cypress Source Code and derivative works for the sole purpose of creating custom software and or firmware in support of licensee product to be used only in conjunction with a Cypress integrated circuit as specified in the applicable agreement. Any reproduction, modification, translation, compilation, or representation of this Source Code except as specified above is prohibited without the express written permission of Cypress.

Disclaimer: CYPRESS MAKES NO WARRANTY OF ANY KIND, EXPRESS OR IMPLIED, WITH REGARD TO THIS MATERIAL, INCLUDING, BUT NOT LIMITED TO, THE IMPLIED WARRANTIES OF MERCHANTABILITY AND FITNESS FOR A PARTICULAR PURPOSE. Cypress reserves the right to make changes without further notice to the materials described herein. Cypress does not assume any liability arising out of the application or use of any product or circuit described herein. Cypress does not authorize its products for use as critical components in life-support systems where a malfunction or failure may reasonably be expected to result in significant injury to the user. The inclusion of Cypress' product in a life-support systems application implies that the manufacturer assumes all risk of such use and in doing so indemnifies Cypress against all charges.

Use may be limited by and subject to the applicable Cypress software license agreement.