

REV. (版本号)	DESCRIPTION (变更说明)	DATE (日期)	APPD (核准)
A0	新订图面	2020.09.10	ZHUANG

料号: PTCMW-H16B-007	
线路原理图	
PLUG端	PCB焊盘
A1, A12, B1, B12, Shell	GND
A4, A9, B4, B9	VBUS
A5	
A6	Dp1
A7	Dn1

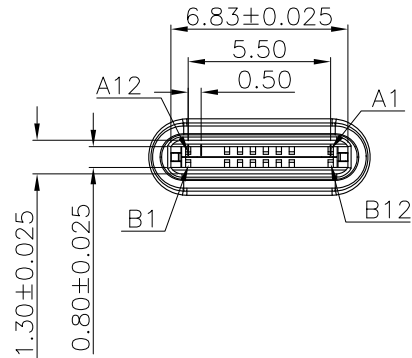
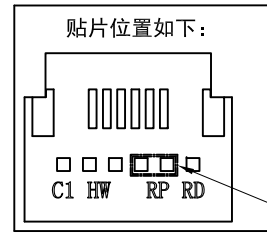

- NOTES:
1. 沾锡性: 温度 $250\pm 5^{\circ}$, 时间 $5\pm 0.5s$
 2. PCB板规格: 带板2.0, 带电阻56K

- NOTES:
1. MECHANICAL: (机械性能)
 - 1.1 MATING FORCE: 5-20N MAX.
插入力: 5-20N 最大。
 - 1.2 UNMATING FORCE: 8-20N MIN
拔出力: 8-20N 最小。
 - 1.3 DURABILITY: 10000 CYCLES
耐久: 10000次
 2. ELECTRICAL: (电气性能)
 - 2.1 CONTACT CURRENT RATING: 1.25A/PIN FOR VBUS AND GND,
0.25A/PIN FOR ALL OTHER CONTACT.
电流: 对VBUS和GND为1.25A/PIN, 其它为0.25A/PIN.
 - 2.2 DIELECTRIC WITHSTANDING VOLTAGE: 100V AC AT SEA LEVEL.
耐压: 100V AC AT SEA LEVEL.
 - 2.3 LOW LEVEL CONTACT RESISTANCE: 40mΩ MAX FOR VBUS AND GND,
50mΩ MAX FOR OTHER CONTACTS.
接触阻抗: VBUS和GND, 40mΩ 最大; 其它为50mΩ.
 - 2.4 INSULATION RESISTANCE: 100MΩ MIN AT 250VDC.
绝缘阻抗: 在电压250VDC, 100MΩ 最小。
 - 2.5. OPERATING TEMPRATUR: $-55^{\circ}\sim 85^{\circ}$. E
 3. COMPLANARITY OF SMT TERMIANL IS 0.10MAX.
焊接端子平面度最大不超过0.10MM.

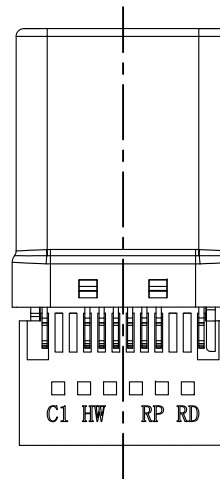
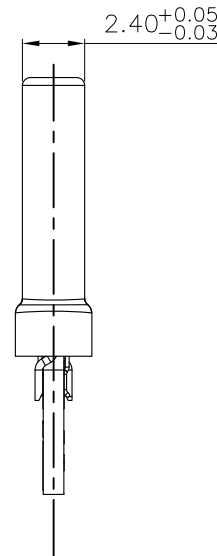
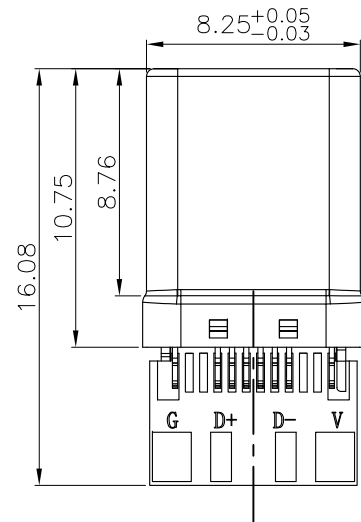

A1	GND	B12	GND
A2	SSTXP1	B11	SSRXP1
A3	SSTXN1	B10	SSRXN1
A4	VBUS	B9	VBUS
A5	CC1	B8	SBU2
A6	DP1	B7	DN2
A7	DN1	B6	DP2
A8	SBU1	B5	CC2
A9	VBUS	B4	VBUS
A10	SSRXN2	B3	SSTXN2
A11	SSRXP2	B2	SSTXP2
A12	GND	B1	GND
PIN	SIGNAL NAME	PIN	SIGNAL NAME

深圳市宇文发电子科技有限公司 Shen Zhen Yu Wen Fa Electronics Technology Co., Ltd TEL: 0755-27711235 FAX: 0755-27712683		页码 (SHEET)	1/1	单位(UNIT): MM	
		版本 (REV)	A0	比例(SCALE) 1:1	
品名 (ITEM NO)	TYPE C 无EMI款公头带板带56K电阻-成品	日期 (DATE)	2020.09.10	未注公差 TOLERANCE UNSPECIFIED X.X ±0.30 X.XX ±0.20 X.XXX ±0.10 X° ±5° X.X° ±2°	
料号 (PART NO)	PTCMW-H16B-009	设计 (DESIGN)	ZHUANG		
图号 (DWG NO)	P-TCM-003	审核 (CHECKED)			
		图号 (DWG NO)	P-TCM-003	核准 (APPROVED)	

RoHS Compliant

REV.	ECN NO	DESCRIPTION	REVISER	DATE
A/0				
A/1				



① PE袋.

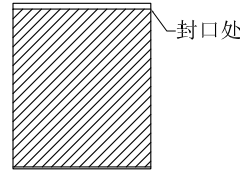
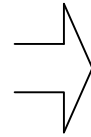

② 1000PCS/袋，并用封口机封口

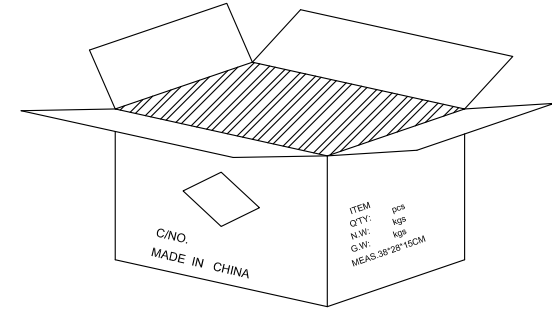
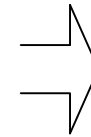

③ 10K/箱.



外箱物料标签

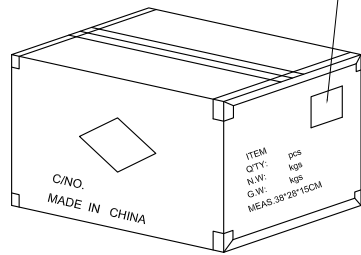

⑥ 依图示粘贴产品或ROHS标签.

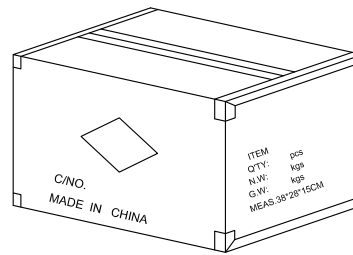
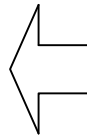

⑤ 外箱用透明胶纸带封“工”字型.

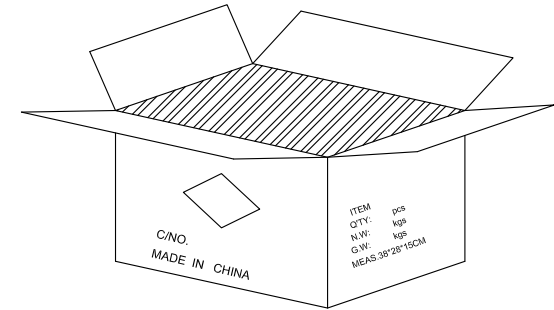
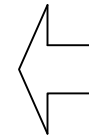

④ 每箱放置10K =10袋，若尾数箱在空间处加装填充物

备注:

1. PE袋.
2. 每袋装1000Pcs/袋;
3. 每箱装10K=10袋;
4. 外箱尺寸38.0*28.0*15cm;
5. 外箱用透明胶纸带封“工”字型;
6. 依外箱图示位置粘贴好产品或ROHS标签.

图号 (DWG NO)		单位 (UNIT): MM	深圳宇文发电子科技有限公司 TEL:0755-27711235 FAX:0755-27712683	
日期 (DATE)	2012/06/27	比例 (SCALE) 1:1		
版次 (REV): A/0	页/次(PAGE): 1/1		品名 (ITEM NO) TYPE C 无EMI款公头带板包规 料号 (PART NO)	
设计 (DESIGN)	李丰桔	包装规范		
审核 (CHECKED)	吴华兴			
核准 (APPROVED)				