

HX3152-S bus transceiver

The HX3152-S is a high-speed RS485/RS-422 transceiver circuit that operates on a +5V power supply with half-duplex functionality. It features one driver and one receiver, achieving transmission speeds of up to 10Mbps.

The circuit includes $\pm 15\text{KV}$ ESD protection to safeguard the chip from electrostatic discharge. Both the driver and receiver have enable pins (DE and RE). When these pins are disabled, the output enters a high-resistance state. Additionally, the HX3152-S incorporates a fail-safe circuit that ensures correct output in open or short circuits at the receiver input. The receiver's input impedance is 1/8 unit load, allowing for a maximum of 256 transceivers on the same bus.

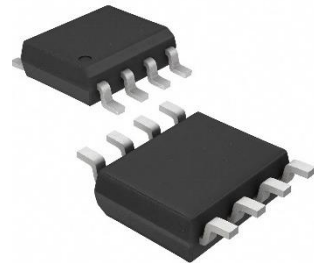

SOP-8

Characteristic

- Tri state output.
- Electrostatic Discharge (ESD): A/B $\pm 15\text{KV}$, compliant with Human Body Mode (HBM) standards.
- The bus allows up to 256 transceivers to be connected.
- Powerful swing rate limitation helps achieve error free data transmission.
- Adopting SOP8 encapsulation.

Application

- Industrial control
- RS485/RS422
- InterfacelIndustrial motor drive
- electricity meter
- Automated HVAC system

Chip Pin Description

ID	NUME	Function
1	RO	Receiver data output
2	$\overline{\text{RE}}$	The receiver output is effective at low levels and high when high.
3	DE	SET: High valid when DE low, output high
4	DI	Drive data input
5	GND	Ground
6	A	Driver data output, receiver data Input
7	B	Driver data output, receiver data Input
8	Vcc	power supply

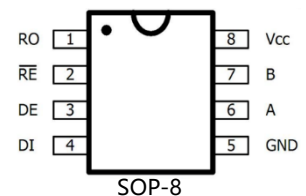

Driver Truth Table

Input	Enable		Output	
	DI	DE	A	B
H	H	H	H	L
L	H	L	L	H
X	L	X	Z	Z

Receiver Truth Table

Input		Output	
$\overline{\text{RE}}$	DE	A-B	RO
L	X	$\geq -50\text{mV}$	H
L	X	$\leq -200\text{mV}$	L
L	X	open circuit	H
L	X	short circuit	H
H	H	X	Z
H	L	X	Z

Dc Electrical Parameter							
Limiting Parameter							
SYMBOL	PARAMETER NAME	MIN	MAX	UNIT			
VCC	Supply voltage		+6.0	V			
DE, RE	Control input voltage	-0.5	+6.0	V			
DI	Drive input voltage	-0.5	+6.0	V			
A,B	Drive output voltage/receive input voltage	-7.0	+12.0	V			
RO	Receiving output voltage	-0.3	VCC+0.3	V			
TSTG	Storage temperature range	-55	+150	°C			
TOP	Operating temperature range	-40	+85	°C			
TMOP	Maximum operating temperature range	-55	+125	°C			
P _D	SOP-8 (+70°C or above)		470	mW			
T _L	Solder temperature (10 seconds)		+300	°C			
DC characteristics (unless otherwise specified, Vcc=5V ± 5%, TA=25 °C) 2							
ARGUMENT	SYMBOL	Test condition		MIN	TYP	MAX	UNIT
Working voltage range	Vcc			4.5		5.5	V
Driver differential output (no load)	VOD1	-		-		5	V
Driver differential output (with load)	VOD2	R=54 or R=27 Figure 1		1.5		-	V
AVDV_DO_Driver1	ΔV _{OD}			-		0.2	V
Driver common mode output voltage	VOC			1		3	V
VCOM_DRV1	ΔV _{OC}					0.2	V
Input high voltage	VIH	DE,RE,DI		2			V
Input undervoltage	VIL	DE,RE,DI				0.8	V
Input current	IIN1	DE,RE,DI				±2	uA
Input current (A, B)	IIN2	DE=0V, Vcc=5V	VIN=5V VIN=0V		40 60	90 100	uA
Receiver differential input threshold voltage	VTH	-7V ≤ V _{CM} ≤ +12V		-200		-50	mV
Receiver input delay	ΔV _{TH}				25		mV
Receiver output high level	VOH	I _O =-8mA		4			V
Receiver output low level	VOL	I _O =8mA				0.4	V
RT-HI-OC	IOZR	0.4V ≤ V _O ≤ 2.4V				1	uA
Receiver input impedance	RIN	-7V ≤ V _{CM} ≤ +12V		96			kΩ
No load operating current	ICC	no-load	DE = Vcc RE=DI=GND or Vcc DE=GND		480 450	600 600	uA
Receiver output short-circuit current	IOSR	0V ≤ V _{RO} ≤ VCC				95	mA
ESD protection		Between A/B, human body mode		±8	±15		kV
Switch characteristics not specified otherwise Vcc=5V ± 5%, TA=25°C							
Parameter	Symbol	Test Conditions		MIN	TYP	MAX	UNIT
Drive input to output	tDPLH	R _{DIFF} =50Ω		250		1000	nS
	tDPHL			250		1000	nS
Driver output offset tDPLH - tDPHL	tDSKEW	C _{L1} =C _{L2} =100Pf			-3	±100	nS
Drive up and down time	tDR	Figure3, 5		200		750	nS
	tDF			200		752	nS
Driver enables high output	tDZH	C _L 00pF Figure4,6 S2 close				2500	nS
Driver enables output to be low	tDZL	C _L =100pF Figure4,6 S1 close				2500	nS
Drive from low to off	tDLZ	C _L =15pF Figure4,6 S1 close				100	nS
Drive from high to off	tDHZ	C _L =15pF Figure4,6 S2 close				100	nS
Receiver Input to output	tRPLH	V _{ID} ≥ 2.0V; V _{ID} Rising and falling				200	nS
	tRPHL					200	nS
Differential receiver offset	tRSKEW	time ≤ 15nS Figure 7,9			3	±30	nS
The receiver stays on until output is low	tRZL	C _L =100pF Figure 2,8			20	50	nS
Enable the receiver to output high	tRZH	C _L =100pF Figure 2,8			20	50	nS
Receiver from low to off	tRLZ	C _L =100pF Figure 2,8			20	50	nS
Receiver from high to off	tRHZ	C _L =100pF Figure 2,8			20	50	nS
Driver output short-circuit current	I _{OD}	Short circuit current between A/B				100	mA

Maximum data speed	fMAX	250	500		Mbps
Communication error rate		Communication speed 250kbps		10 ⁻⁷	

Notes : 1 ΔVOD and ΔVOC respectively represent the changes in VOD and VOC when DI changes.
 2 When the current flows into the device, it is positive, and when it flows out of the device, it is negative; Unless otherwise specified, all voltages are referenced to ground.

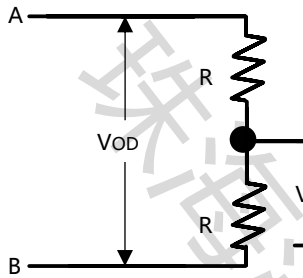

Figure 1 DC characteristic test load of driver

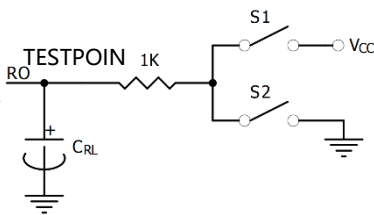

Figure 2 Receiver Enable/Off Switch Characteristics Test Load

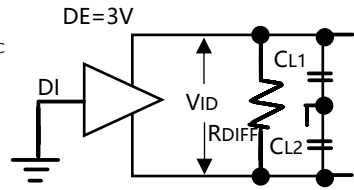

Figure 3 Driver switch characteristic test circuit

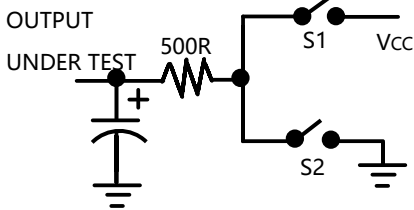

Figure 4 Driver Enable/Off Switch Characteristics Test Load

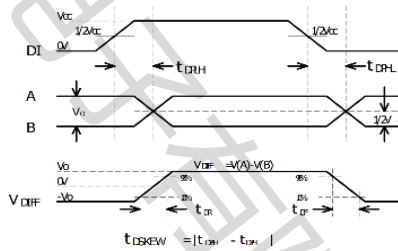

Figure 5 Drive transmission delay

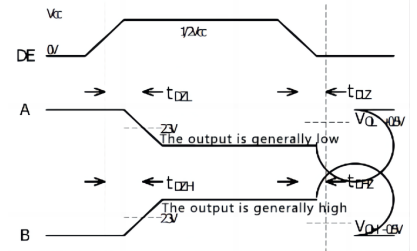

Figure 6 Driver Enable/Off Timing

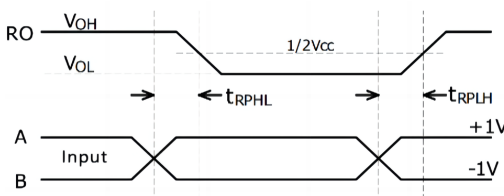

Figure 7 Receiver transmission delay

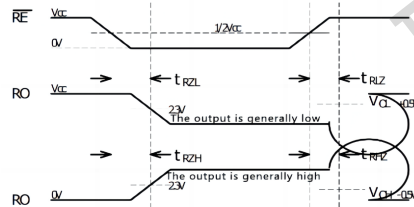

Figure 8 Receiver Enable/Off Timing

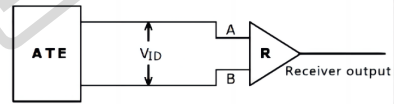
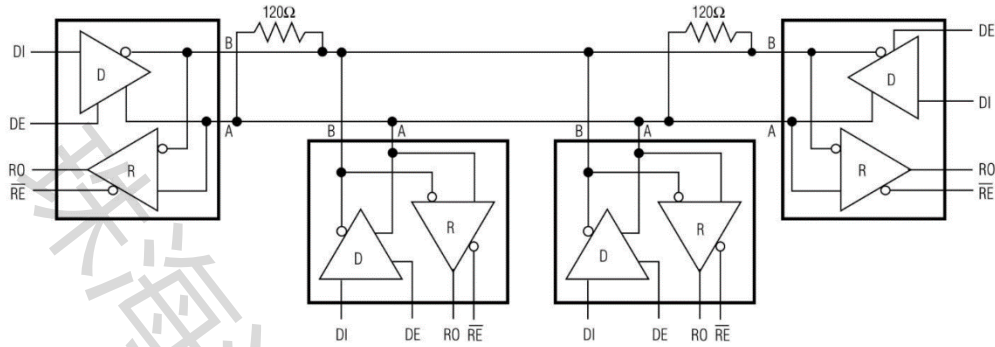

Figure 9 Receiver Transmission Delay Test

Typical Application



Packaging and packaging

SOP8 (Package Outline Dimensions)

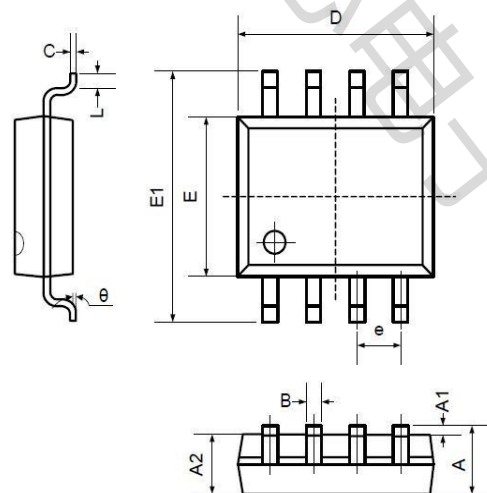

Symbol	Dimensions In Millimeters		Dimensions In Inches	
	Min	Max	Min	Max
A	1.350	1.750	0.053	0.069
A1	0.100	0.250	0.004	0.010
A2	1.350	1.550	0.053	0.061
B	0.330	0.510	0.013	0.020
C	0.190	0.250	0.007	0.010
D	4.780	5.000	0.188	0.197
E	3.800	4.000	0.150	0.157
E1	5.800	6.300	0.228	0.248
e	1.270TYP		0.050TYP	
L	0.400	1.270	0.016	0.050
theta	0°	8°	0°	8°

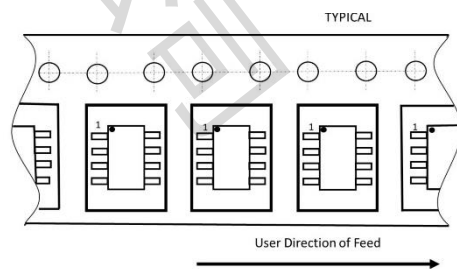
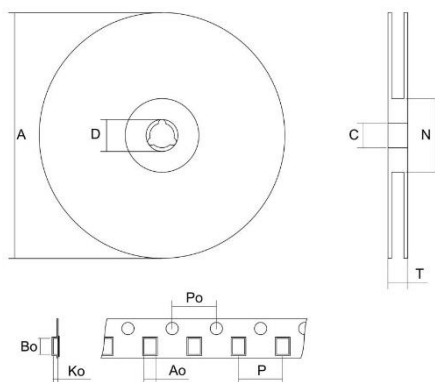

Packaging Method	Number
Braid	2500PCS/Disk