

ROHS

REVISIONS					
REV.	ECN NO.	LOCATION	DESCRIPTION	DATE	DESIGN
A0	N/A		INITIAL RELEASE	2024.08.09	

8.50 [0.335]

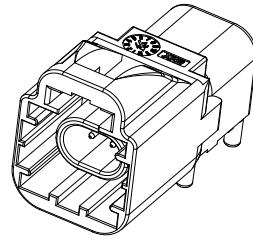
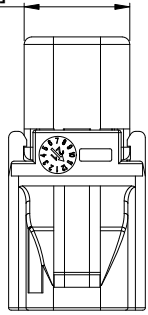

3D View

Specifications(规格):

- 1.Impedance(特性阻抗) : 100Ω;
- 2.Frequency (工作频率) : DC~10GHz;
- 3.Return Loss (回波损耗) :  $\geq 20\text{dB}$  @DC~3GHz;
- 4.Insulation resistance(绝缘阻抗) :  $\geq 100\text{M}\Omega$ ;
- 5.Dielectric withstand voltage (介质耐电压) : 250V AC;
- 6.Mating cycles (耐久性) :  $\geq 25$  cycles;
- 7.Engagement force(啮合力) :  $\leq 20\text{N}$ ;
- 8.Retention force latch(轴向保持力) :  $\geq 110\text{N}$ ;
- 9.Temperature range(使用温度) :  $-40^{\circ}\text{C} \sim +105^{\circ}\text{C}$ ;

11.00 [0.433]

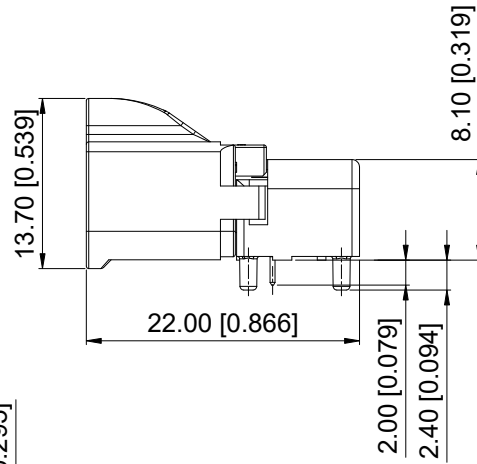
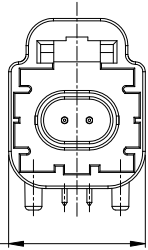

2-0.40 [0.016]

4-Ø1.36 [0.053]

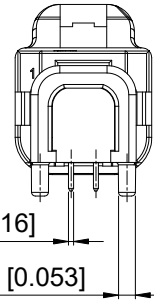

PART NO.:

XTORWM13-NJ05-X

Code: A~Z

2.00 [0.079]

7.00 [0.276]

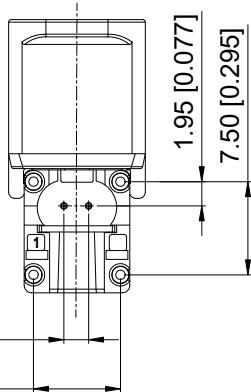

4-Ø1.70 [0.067]

2-Ø0.70 [0.028]

PCB edge

2.00 [0.079]

7.00 [0.276]

1.95 [0.077]

7.50 [0.295]

10.50 [0.413]

Recommended P.C.B Layout

ANGULAR	$\pm 5^{\circ}$
X.	$\pm 0.50$
X.x	$\pm 0.30$
X.xx	$\pm 0.20$
X.xxx	$\pm 0.10$

UNSPECIFIED TOLERANCES

5	Cover	Copper Alloy	Tin PLATED	1 PC	
4	Dielectric	LCP		1 PC	
3	Outer Conductor	Zinc Alloy	Tin PLATED	1 PC	
2	Center Conductor	Copper Alloy	Gold PLATED	2 PCS	
1	Housing	PPA		1 PC	
NO.	SPEC.	MATERIAL	FINISH (Contact)	Q'TY	Note
		www.helloxkb.com	www.helloxkb.cn	www.xk-dg.cn	



DESIGN	希文	VIEW:		MODEL TYPE: H-MTD Male R/A Connector, single	
CHECKED		UNIT:	mm/in	PART NO.: XTORWM13-NJ05-X	
APPROVED		SIZE:	A4	DWG NO.: X-XTORWM13-NJ05-X	
			SCALE	PAGE	REVISION
			N/A	1/2	A0

XKB INDUSTRIAL PRECISION CO.,LIMITED

REVISIONS					
REV.	ECN NO.	LOCATION	DESCRIPTION	DATE	DESIGN
A0	N/A		INITIAL RELEASE	2024.08.09	

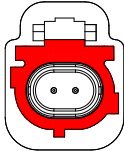
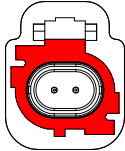
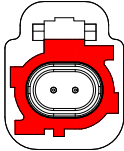
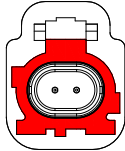
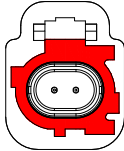
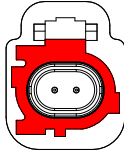
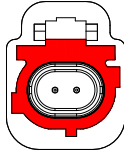
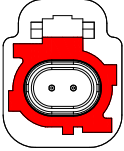
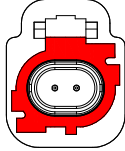
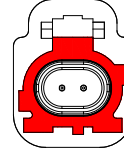
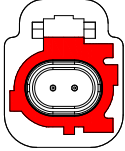
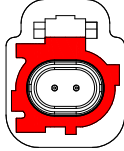
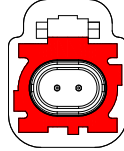
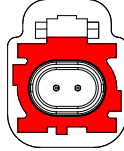
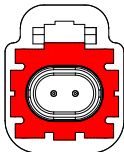
Code List:							
Colde							
	A	B	C	D	E	F	G
Color/RAL-No.	Black/9005	White/9010	Blue/5012	Bordeaux/4004	Green/6017	Brown/8011	Grey/7036
PART NO.	XTORWM13-NJ05-A	XTORWM13-NJ05-B	XTORWM13-NJ05-C	XTORWM13-NJ05-D	XTORWM13-NJ05-E	XTORWM13-NJ05-F	XTORWM13-NJ05-G
Colde							
	H	J	K	L	M	O	Z
Color/RAL-No.	Violet/3015	Beige/1001	Curry/1027	Yellow green/6018	Pastel orange/2003	Light green/6027	Water blue/5021
PART NO.	XTORWM13-NJ05-H	XTORWM13-NJ05-J	XTORWM13-NJ05-K	XTORWM13-NJ05-L	XTORWM13-NJ05-M	XTORWM13-NJ05-O	XTORWM13-NJ05-Z
Colde							
	T						
Color/RAL-No.	Water blue/5021						
PART NO.	XTORWM13-NJ05-T						

ANGLAR	±5°
X.	±0.40
X.x	±0.30
X.xx	±0.20
X.xxx	±0.15
UNSPECIFIED TOLERANCES	



DESIGN	希文	VIEW: 	MODEL TYPE: H-MTD Male R/A Connector, single
CHECKED		UNIT: mm/in	PART NO.: XTORWM13-NJ05-X
APPROVED		SIZE: A4	DWG NO.: X-XTORWM13-NJ05-X
			SCALE   PAGE   REVISION N/A   2/2   A0

XKB INDUSTRIAL PRECISION CO., LIMITED

NOTE: ALL RIGHTS RESERVED, BANNED COPY!