

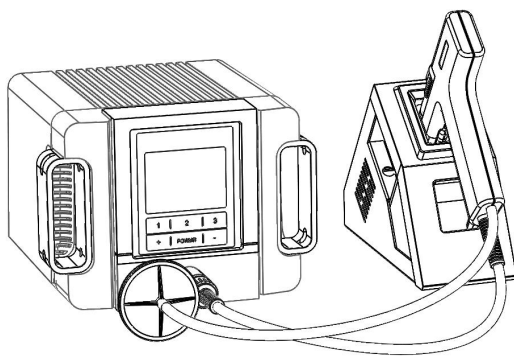

QUICK TV2 Desoldering Tool

Instruction Manual



Thank you for purchasing our products. Please keep the instruction manual properly for future reference.

Contents

1. Safety Instructions.....	1
2. Overview.....	2
3. Product Characteristics.....	2
4. Product Specifications.....	3
5. Functional Descriptions.....	4
5.1. Dimensions.....	4
5.2. Part Descriptions.....	5
5.3. Key Descriptions.....	6
5.4. Function Descriptions of the Main Interface.....	7
6. Connection.....	8
7. Temperature Settings.....	8
8. Menu Settings.....	9
8.1. Channel Temperature Settings.....	9
8.2. Address Settings.....	10
8.3. Sound Switch Settings.....	10
8.4. Password Settings.....	10
8.5. Suction Count Settings.....	11
8.6. Language Settings.....	11
8.7. Sleeping Time Settings.....	12
8.8. Turn Off Settings.....	12

8.9. Temperature Calibration.....	13
9. Operation.....	14
10. Cleaning and Maintenance.....	14
10.1. Maintenance of the Desoldering Nozzle.....	14
10.2. Checking and Cleaning of the Desoldering Nozzle.....	15
10.3. Steps of Installing the External Filter.....	16
10.4. Steps of Installing the External Filter.....	17
11. Replacing the Heater.....	17
11.1. Steps of Removing the Heater.....	17
11.2. Steps of Replacing the Heater.....	17
12. Troubleshooting.....	18
13. Selection of Desoldering Nozzles.....	19

1. Safety Instructions



CAUTION

- During the installation and use of this product, all electrical safety regulations of the country and regions must be strictly observed.
- The power supply must be disconnected when disassembling the product. Do not operate with power on.
- If the product does not work properly, please contact the supplier or our company, and do not disassemble or change the product in any way. We are not responsible for any problems caused by unauthorized maintenance or modification.



WARNING

- Don't install the product in a place where the surface is easy to shake or be impacted, as it may damage the product.
- Don't place the product in places where it may be exposed to rain or moisture.
- The product should be used away from places where there is magnetic interference.
- Don't use in flammable and explosive environments.
- After using the desoldering station, the nozzle temperature will be quite high, which is easy to burn operators and may cause dangerous accidents.
- Don't knock workbench with the desoldering gun to remove residual flux, which may seriously damage the desoldering gun.
- After the desoldering gun is used, a layer of melting tin should be plated to prolong its life before placing it into the holder.
- Please unplug the power cord when the product is not used for a long time.

2. Overview

This desoldering tool uses high-frequency eddy current heating, which makes the nozzle heat up quickly to melt the solder in the pad of the PCB through-hole devices. The vacuum pump is started by the switch of the desoldering gun switch to generate vacuum to suck the liquid tin into the tin storage tube to achieve the purpose of quickly disassembling the through-hole components. At the same time, it can also be used for tin removal on the surface of the pad to improve maintenance efficiency.

3. Product Characteristics

- LCD display, touch button for comfortable operation.
- Novel appearance design.
- Powerful built-in vacuum pump.
- Precise digital temperature calibration.
- Function of counting tin absorbing times.
- Support the function of preventing blockage.

4. Product Specifications

Product model	TV2
Power consumption	200W
Voltage	AC 220V/230V
Temperature range	300°C~500°C
Temperature stability	±2°C (No load)
Dimensions (L*W*H)	189.5*189.0*135mm
Weight	About 3.2 Kg

5. Functional Descriptions

5. 1. Dimensions

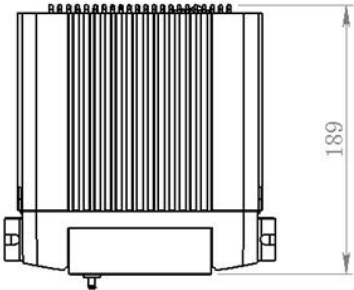
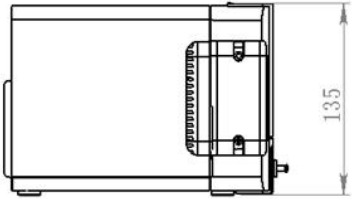

Unit: mm

5. 2. Part Descriptions

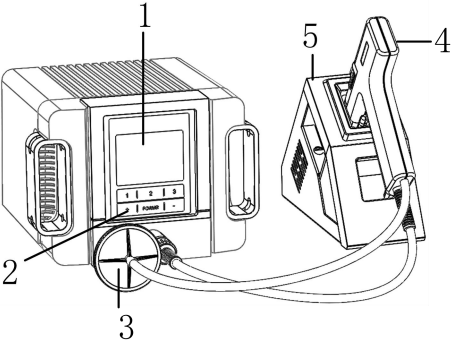









NO.	Part Descriptions
1	LCD Display
2	Touch Buttons
3	External Filter
4	Desoldering Gun
5	Desoldering Gun Holder

5. 3. Key Descriptions

Key	Function Descriptions
+/-	Temperature up/down 1. Short press, temperature goes up or down by 1°C. 2. Long press, temperature goes up or down quickly.
POWER	1. Power on: Press and hold the "POWER" button to turn on 2. Power off: Press and hold the "POWER" button to turn off
2/3	Press "2" and "3" keys at the same time to enter the menu setting interface
1/+/-	1. Press "1" or "+" or "-" to switch the menu in the menu setting interface. 2. Press "1" to switch parameter options, press "+" or "-" to change the parameter value in the parameter setting interface.
1/3	Press "1" and "3" keys at the same time to enter the temperature calibration interface.

5. 4. Function Descriptions of the Main Interface

	CHO	
		°C
	300	=
		
350	380	400

Symbols	Descriptions	Symbols	Descriptions
CHO	Temporary channel	CH1~CH3	Channel 1 to Channel 3 optional
	Password lock		No password lock
	<p>1. Red indicates the heating state;</p> <p>2. Black indicates the no heating state;</p> <p>3. Alternating red and black indicates constant temperature.</p>	°C	Celsius
	Buzzer on		Buzzer off

6. Connection

Connecting the desoldering gun assembly: make the external filter and the hose of the desoldering gun connected (as shown in the figure below).

- 1) Insert the power cord into the power socket.
- 2) Connect the external filter with hose of the desoldering gun.
- 3) Turn on the power switch, and the desoldering gun starts heating.
(Note: Do not start the desoldering gun switch if the temperature does not rise to the setting temperature).

Note: The external filter has its connection direction, and it shall be connected according to the label, otherwise it will affect the suction of the machine.

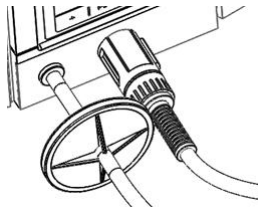

7. Temperature Settings

There are 3 temperature channels in total. Press the "1", "2" and "3" keys on the main unit to quickly select the saved temperature corresponding to CH1, CH2 and CH3 respectively. The current temperature value can be changed with the "+" and "-" keys, but the saved temperatures of the 3 temperature channels will not be overwritten.

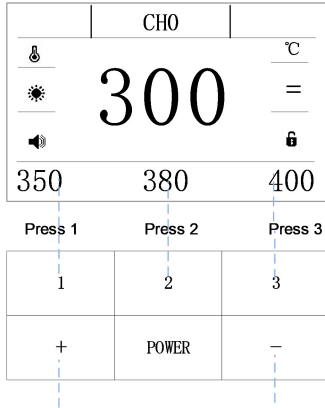

Press +/- button once to increase/decrease 1°C, press and hold it to continuously increase/decrease.

8. Menu Settings

Enter the menu setting interface.

Long press "2" and "3" keys at the same time to enter the menu setting interface.

8. 1. Channel Temperature Settings

- 1) Press "2" key to enter "Channel Temp" setting interface.
- 2) Press "1" to select channel 1~3, and press the "+" or "-" to change the value.
- 3) Press "2" to save, press "3" to return to the main interface.

SET	
▶ Channel Temp	CH1: 350°C
● Address	CH2: 380°C
● SoundSwitch	CH3: 400°C
● Password	
● SuctionCount	
>>> CONFIRM BACK	

SET	
▶ Channel Temp	CH1: 350°C
● Address	CH2: 380°C
● SoundSwitch	CH3: 400°C
● Password	
● SuctionCount	
>>> SAVE BACK	

SET	
▶ Channel Temp	CH1: 355°C
● Address	CH2: 380°C
● SoundSwitch	CH3: 400°C
● Password	
● SuctionCount	
>>> SAVE BACK	

8. 2. Address Settings

- 1) Press "1", "+" or "-" key to select "Address" interface.
- 2) Press key "2" to enter address parameter selection, press "+" or "-" to set the address, and the address setting range is: 001~255.
- 3) Press "2" to save, press "3" to return to the main interface.

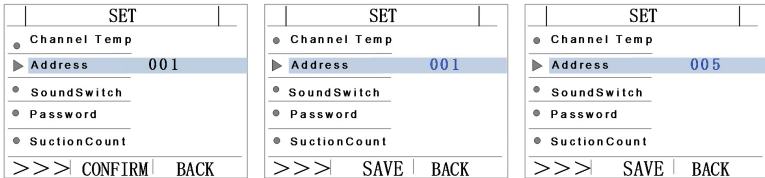

8. 3. Sound Switch Settings

- 1) Press "1", "+" or "-" key to select "Sound Switch" interface.
- 2) Press "2" to enter the sound switch setting interface. Press "1" to select ON or OFF to switch the sound function.
- 3) Press "2" to save, press "3" to return to the main interface.

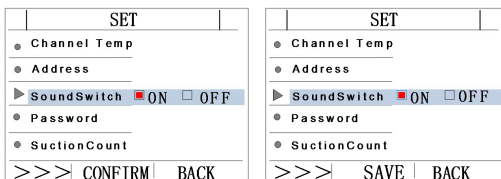

8. 4. Password Settings

- 1) Press "1", "+" or "-" key to select "Password" interface.

- 2) Press "2" to enter the password input setting interface. Press the "+" or "-" key to select the value (0 ~ 9) and press "1" to change the digit. After inputting the old password 000000 (original password), press key "1" to enter the new password input interface.
- 3) Press "2" to save, press "3" to return to the main interface.

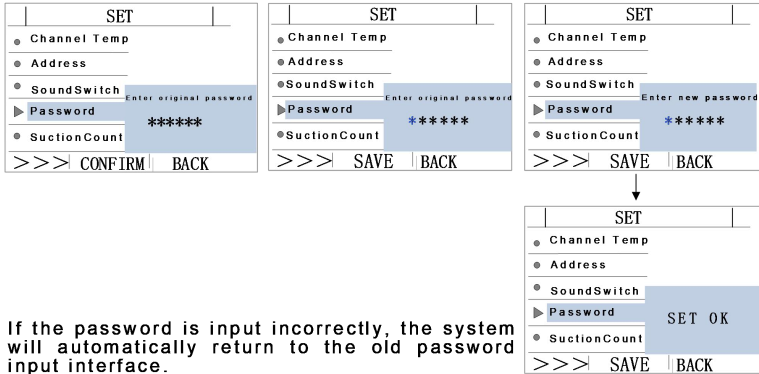

8. 5. Suction Count Settings

- 1) Press "1", "+" or "-" key to select "Suction count" setting interface.
- 2) Press the key "2" to enter the suction count parameter interface. Press the key "-" to clear the suction count data.
- 3) Press "2" to save, press "3" to return to the main interface.

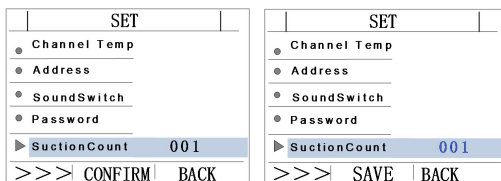

8. 6. Language Settings

- 1) Press "1", "+" or "-" key to select "Language" setting interface.

- 2) Press "2" to enter the language selection interface, and press "+" or "-" to switch between S-Chinese, English and T-Chinese.
- 3) Press "2" to save, press "3" to return to the main interface.

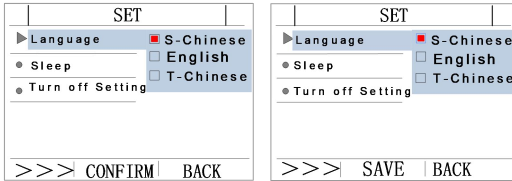

8. 7. Sleeping Time Settings

- 1) Press "1", "+" or "-" key to select "Sleep" setting interface.
- 2) Press the key "2" to enter the sleep setting interface, press the "+" or "-" key to select the sleep setting ON or OFF, after selecting ON, press the "1" key to set the time, the time setting range is : 001min to 020 mins.
- 3) Press "2" to save, press "3" to return to the main interface.

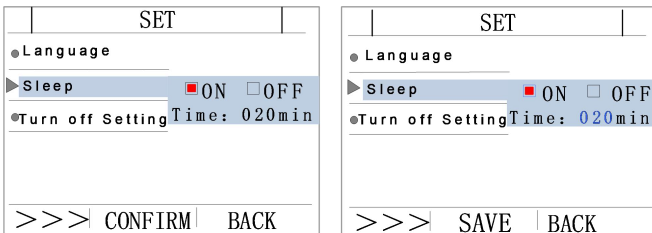

8. 8. Turn Off Settings

- 1) Press "1", "+" or "-" key to select "Turn off Setting" interface.
- 2) Press key "2" to enter the turn off setting interface, press the "+" or "-" key to select the turn off function ON or OFF, and then press key "1" to set the time. The time setting range is 001min ~ 040 mins.
- 3) Press "2" to save, press "3" to return to the main interface.

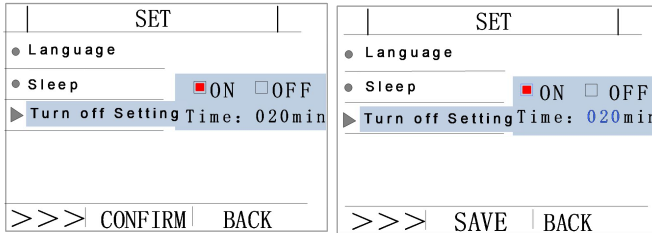

8. 9. Temperature Calibration

It is recommended to recalibrate the temperature of the machine after replacing the desoldering gun, heating element or nozzle.

- 1) Set the temperature of the machine according to your needs.
- 2) When the temperature is stable, test the nozzle temperature with the thermometer and record the reading value.
- 3) Long press the keys "1" and "3" at the same time, and the machine will enter the temperature calibrating mode.
- 4) Press the "+" or "-" key to input the temperature value on the thermometer, and press the "2" key to confirm.
- 5) If the temperature still has errors, repeat the calibration according to the above steps.

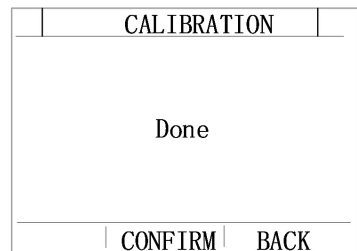
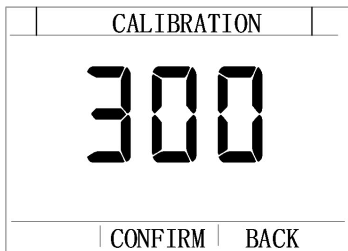

* It is recommended to use a 191/192 thermometer to measure the tip temperature.

* If the password is locked, the temperature cannot be calibrated, and the correct password must be input to operate.

9. Operation

Melting solder After the set temperature is stable, use the nozzle of the desoldering tool to melt the solder.

Solder removal After confirming that all the soldering tin has been melted, press the red switch (trigger) on the handle to suck the soldering tin.

Note: 1) To check if the solder is completely melted, observe the inside of the aperture and the back of PCB, if it is difficult, use the nozzle to shake the pin slightly. If it can be moved, it means that the solder has been melted.

2) Do not shake the pins vigorously. If the pin does not move easily, it indicates the solder has not been completely melted

3) Do not leave any solder residue in the PCB aperture.

10. Cleaning and Maintenance

10. 1. Maintenance of the Desoldering Nozzle

After using the desoldering tool, please make maintenance to ensure durability. Solder removal efficiency depends on temperature, quality and quantity of solder and flux. Please follow the following procedures for maintenance according to the usage of the desoldering tool:

1) Apply a little solder to the plating part of the nozzle to keep the nozzle shiny.

2) If the nozzle is covered with oxide, the thermal conductivity will be weakened. Apply a little new solder on the nozzle to exert the thermal conductivity function.

3) Remove the solder inside the nozzle and the heating element, then clean the nozzle with the cleaner, and plate a layer of solder on the nozzle to protect the coating.

Note: After the desoldering gun is used, the temperature is too high. During maintenance, please wait it to cool down or wear heat insulation gloves for safe operation.

10. 2. Checking and Cleaning of the Desoldering Nozzle

1) Insert the plug into the power socket, and turn on the power switch to heat the nozzle.

2) Clean the nozzle hole with a nozzle needle.



3) If there is slight wear and tear, please re-solder the nozzle with new solder to avoid oxidation.

4) If the nozzle hole is worn or corroded inside and outside, please replace the nozzle.

Note: a. Since it is difficult to observe the erosion of the nozzle with naked eyes, if the tin suction efficiency is reduced while the performance of other parts is good, it may be that the nozzle is eroded and should be replaced with a new one.

b. Please select the appropriate size of the needle according to the diameter of the nozzle. If the solder in the nozzle is not completely melted, the needle cannot penetrate the nozzle, please check the solder coating on the nozzle surface.

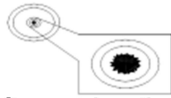
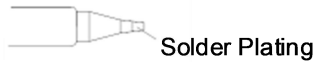

After erosion, the nozzle hole will be enlarged or chipped.

c. A layer of special alloy is plated inside and outside the nozzle aperture. If the alloy layer is eroded due to high temperature, the nozzle will not be able to maintain a proper temperature.

10. 3. Steps of Installing the External Filter

- 1) Press "Off" on the power switch.
- 2) When the filter pipe is cooled, pull the trachea support column to the right and take out the filter pipe.
- 3) Check the solder collector and tin slag ceramic filter cotton.

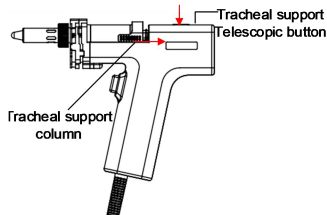

Note: The tin slag ceramic filter cotton needs to be replaced when it is hardened due to the accumulation of solder and flux.

Check the solder collector and replace it when it's full, and also replace the ceramic filter cotton at the same time.

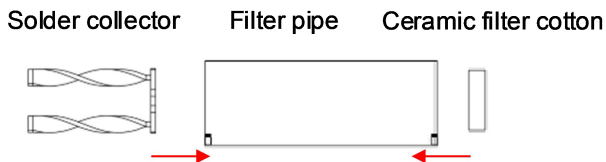

10. 4. Steps of Installing the External Filter

Put the solder collector into the filter pipe, and then put the matching ceramic filter cotton into the filter pipe. Press the trachea support telescopic button to fix the filter pipe.

Note: If a large filter cotton is loaded into the filter pipe, it may damage the desoldering gun or reduce the suction efficiency.

11. Replacing the Heater

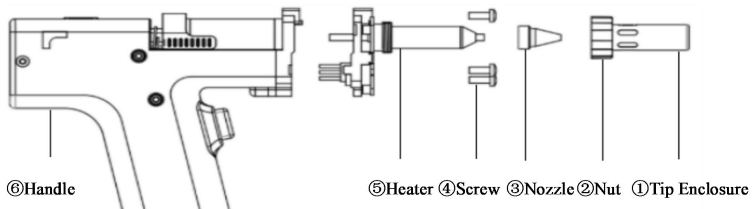

11. 1. Steps of Removing the Heater

- 1) Unscrew ① Tip Enclosure and ② Nut
- 2) Pull out ③ Nozzle
- 3) Unscrew three ④ Screws with a screwdriver
- 4) Pull out ⑤ Heater

Note: All operating steps are performed with the power disconnected and the handle cooled.

11. 2. Steps of Replacing the Heater

- 1) Insert ⑤ Heater into ⑥ Handle body
- 2) Screw on three ④ Screws
- 3) Insert ③ Nozzle

- 4) Screw on ① Tip Enclosure and ② Nut
- 5) After the heater is replaced, please do the following measurements:

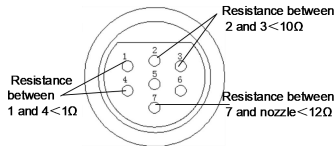

6) After replacing the heater, recalibrate the temperature (refer to temperature calibration).

12. Troubleshooting

NO.	Error display	Error description
1	- - -	The handle is not inserted Check if the handle is fully inserted.
2	S-E	Sensor error The sensor is not inserted or disconnected
3	H-E	Heater error The heater is open circuit or the power supply circuit is not inserted.

13. Selection of Desoldering Nozzles

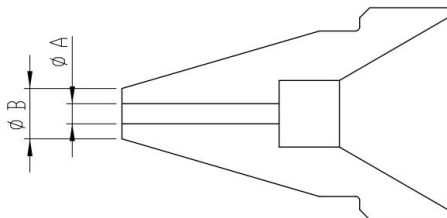

P/N	$\Phi A(\text{mm})$	$\Phi B(\text{mm})$
AN08	0.8	2.3
AN10	1.0	2.5
AN13	1.3	3.0
AN16	1.6	3.0

Warranty Card

●The warranty period of this product is calculated from the date of Purchase. During the warranty period, if the product breaks down during normal use, show the original warranty card and enjoy free service in the authorized repair company(or our company).

Please keep the purchase certificate and this warranty card and show it before maintenance.

●During the warranty period, the following repairs need to be paid:

- Unable to offer valid warranty card or certificate;
- The purchase date, sales company and other items are not completely filled or the warranty card is altered;
- Damage caused by failure to follow the use methods and precautions in the manual;
- Damage caused by disassembly, repair and modification of products without authorization of the manufacturer;
- Replacement of vulnerable and consumable parts.

●All items of the warranty card shall be completely filled in by the agent or user to obtain a 12-month warranty period.

●Please keep this warranty card properly It will not be re-offered after.

QUICK INTELLIGENT EQUIPMENT
CO., LTD.

ADD: NO.11, FengXiang Road, Wujin
High-Tech Industrial Development
Zone, Jiangsu, China

TEL: 86-519-86225678

FAX: 86-519-86558599

POSTCODE: 213167

WEBSITE: www.quick-global.com

Warranty Card

Type: _____

Model No.: _____

Serial No.: _____

Delivery Date: _____

Warranty File Card

Type: _____

Model No.: _____

Serial No.: _____

Delivery Date: _____

Address : _____

Postcode: _____

Telephone: _____

Contact Person: _____

QUICK INTELLIGENT EQUIPMENT CO., LTD.

ADD: NO.11, FengXiang Road, Wujin
High-Tech Industrial Development Zone,
Jiangsu, China

TEL: 86-519-86225678

FAX: 86-519-86558599

POSTCODE: 213167

WEBSITE: www.quick-global.com

