

REV. (版本号)	DESCRIPTION (变更说明)	DATE (日期)	APPD (核准)
A2	增加端子弹高管控	2017/08/05	Suny
A3	修正图面与实物相符	2018/12/12	Lee
A4	增加焊脚尺寸管控	2022/06/29	Yuxiang

规格说明:Specifications:

电气特性:Electrical:

1. 额定电流: Current Rating  
1.0A/contact terminal
2. 额定电压: Voltage Rating  
30V DC
3. 接触阻抗: Contact Resistance  
50 milliohms MAX
4. 耐电压: Dielectric Withstanding Voltage:  
300 V AC AT Sea Level
5. 绝缘阻抗: Insulation Resistance:  
100MEGA ohms MIN

原材料:Raw material:

1. 塑胶: Plastic cement:  
Hing Temperature Thermoplastics,  
LCP Black
2. 端子: Contact: Copper Alloy C5191
3. 外壳: Shell: Copper Alloy C2680

电镀: Electroplate:

1. 端子: Contact: Plated Gold in Mating Area;  
Tin On Solder Talls
2. 外壳: Shell:  
Nickel Plating

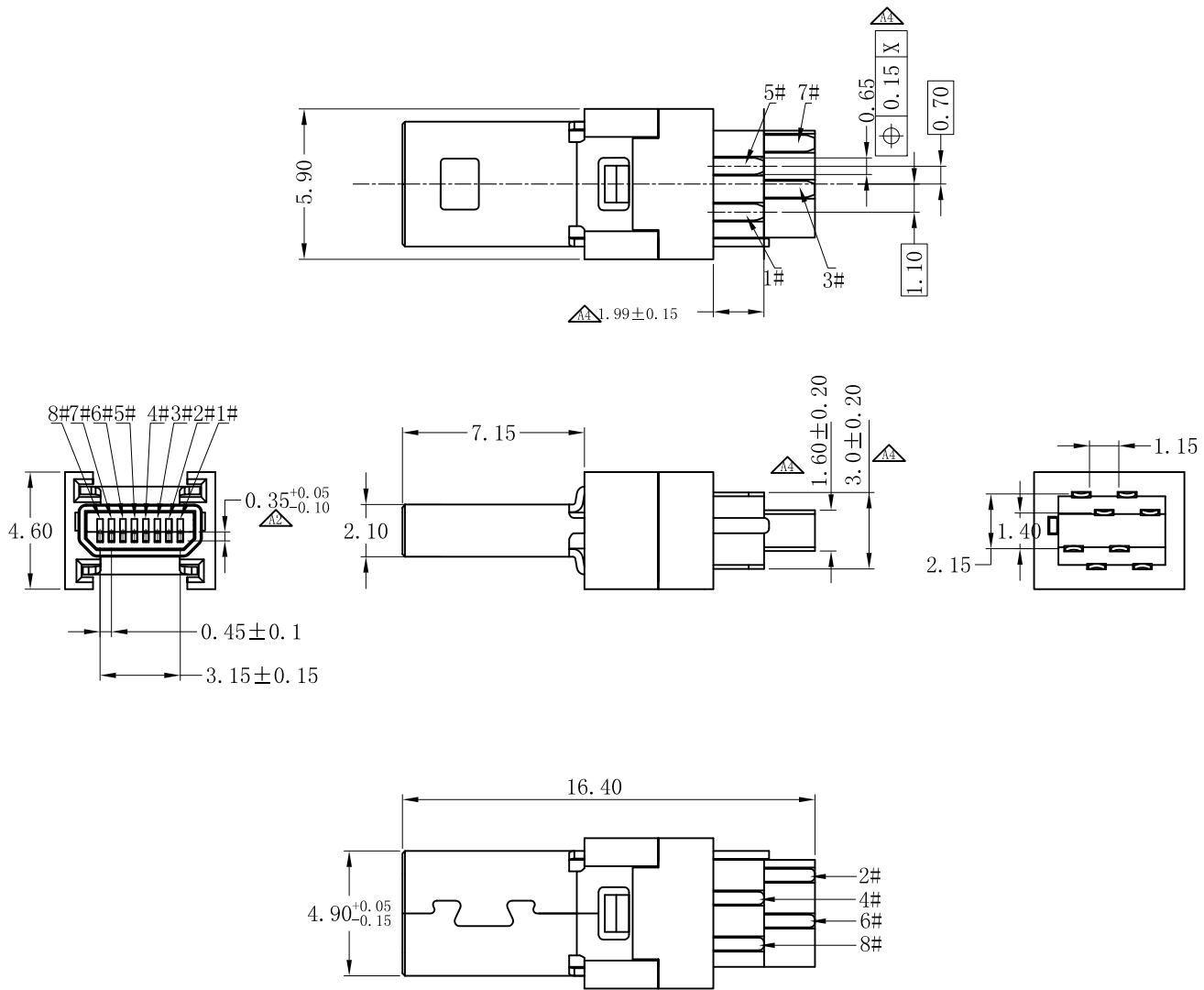

# 1B外壳

 <b>深圳市宇文发电子科技有限公司</b> Shen Zhen Yu Wen Fa Electronics Technology Co., Ltd TEL: 0755-27711235 FAX: 0755-27712683		页码 (SHEET)	1/1	单位 (UNIT): MM
		版本 (REV)	A4	比例 (SCALE) 1:1
品名 (ITEM NO)	MINI USB 8PM 焊线 (自动)	日期 (DATE)	2010.08.11	 <b>未注公差</b> TOLERANCE UNSPECIFIED X.X ±0.30 X.XX ±0.20 X.XXX ±0.10 X° ±5° X.X° ±2°
料号 (PART NO)	PU8MW-R35B-006	设计 (DESIGN)	ZYJ	
图号 (DWG NO)	P-U8M-002 (1A-1-1)	审核 (CHECKED)		
		核准 (APPROVED)		

RoHS Compliant

REV.	ECN NO	DESCRIPTION	REVISER	DATE
A/0				
A/1				

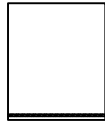

① PE袋.

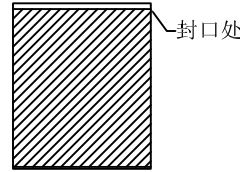
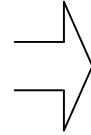

② 1000PCS/袋，并用封口机封口

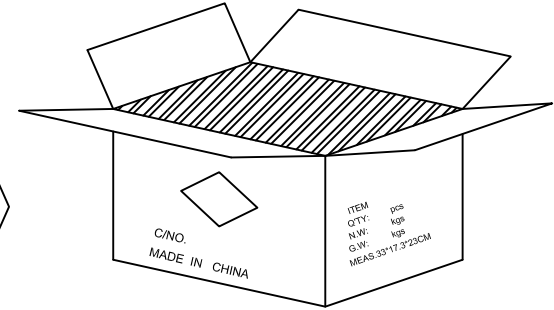
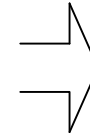

③ 10K/箱.



外箱物料标签

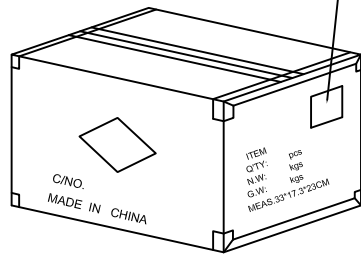

⑥ 依图示粘贴产品或ROHS标签.

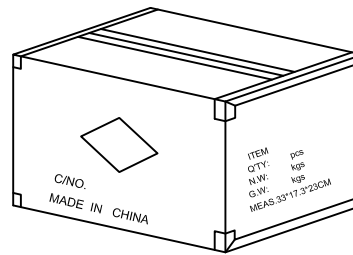
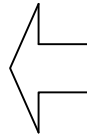

⑤ 外箱用透明胶纸带封“工”字型.

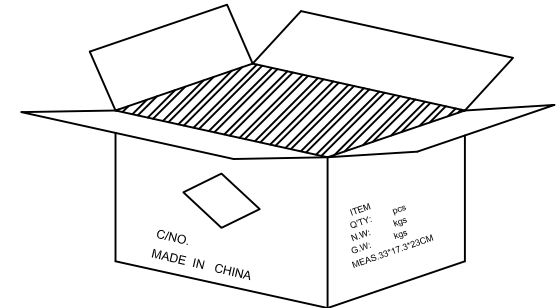
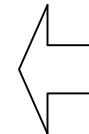

④ 每箱平放10袋，若尾数箱在空间处加装填充物.

备注:

1. PE袋.
2. 每袋装1000Pcs/袋;
3. 每箱装10K=10袋;
4. 外箱尺寸33\*17.3\*23cm;
5. 外箱用透明胶纸带封“工”字型;
6. 依外箱图示位置粘贴好产品或ROHS标签.

图号 (DWG NO)		单位 (UNIT): MM	深圳宇文发电子科技有限公司 TEL: 0755-27711235 FAX: 0755-27712683		
日期 (DATE)	2012/06/27	比例 (SCALE) 1:1			
版次 (REV): A/0	页/次 (PAGE): 1/1		<b>包装规范</b>		
设计 (DESIGN)	李丰桔	品名 (ITEM NO)			MINI USB 8P/M 焊线
审核 (CHECKED)	吴华兴	料号 (PART NO)			
核准 (APPROVED)					