

BSC040N10NS5ATMA1-VB Datasheet  
N-Channel 100V (D-S) MOSFET

PRODUCT SUMMARY		
$V_{DS}$ (V)	$R_{DS(on)}$ ( $\Omega$ )	$I_D$ (A) <sup>a</sup>
100	0.003at $V_{GS} = 10$ V	135
	0.004at $V_{GS} = 4.5$ V	120

FEATURES

- 175 °C Junction Temperature
- SGT technology Power MOSFET
- Material categorization:



RoHS  
COMPLIANT

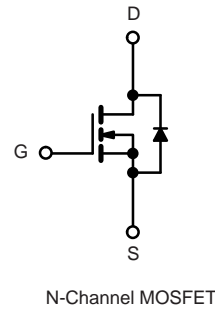
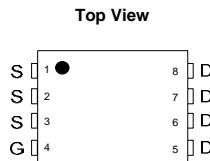
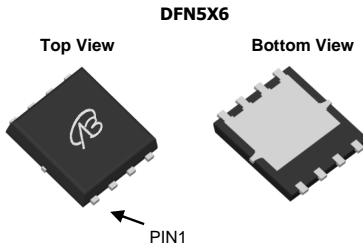

ABSOLUTE MAXIMUM RATINGS ( $T_C = 25$ °C, unless otherwise noted)				
Parameter	Symbol	Limit	Unit	
Gate-Source Voltage	$V_{GS}$	$\pm 20$	V	
Continuous Drain Current ( $T_J = 175$ °C) <sup>b</sup>	$I_D$	$T_C = 25$ °C	135	
		$T_C = 100$ °C	80 <sup>a</sup>	
Pulsed Drain Current	$I_{DM}$	405	A	
Continuous Source Current (Diode Conduction)	$I_S$	140 <sup>a</sup>		
Avalanche Current	$I_{AS}$	75		
Single Avalanche Energy (Duty Cycle $\leq 1$ %)	$L = 0.1$ mH	$E_{AS}$	110	mJ
Maximum Power Dissipation	$P_D$	$T_C = 25$ °C	136	W
		$T_A = 25$ °C	3 <sup>b</sup> , 8.3 <sup>b, c</sup>	
Operating Junction and Storage Temperature Range	$T_J, T_{stg}$	- 55 to 175	°C	

THERMAL RESISTANCE RATINGS					
Parameter	Symbol	Typical	Maximum	Unit	
Maximum Junction-to-Ambient <sup>a</sup>	$R_{thJA}$	$t \leq 10$ sec	15	18	°C/W
		Steady State	40	50	
Maximum Junction-to-Case	$R_{thJC}$	0.85	1.1		

Notes:

- a. Package limited.
- b. Surface mounted on 1" x 1" FR4 board.
- c.  $t \leq 10$  s.

SPECIFICATIONS ( $T_J = 25\text{ }^\circ\text{C}$ , unless otherwise noted)						
Parameter	Symbol	Test Conditions	Min.	Typ. <sup>a</sup>	Max.	Unit
<b>Static</b>						
Drain-Source Breakdown Voltage	$V_{DS}$	$V_{GS} = 0\text{ V}, I_D = 250\text{ }\mu\text{A}$	100			V
Gate Threshold Voltage	$V_{GS(th)}$	$V_{DS} = V_{GS}, I_D = 250\text{ }\mu\text{A}$	1	2	3	
Gate-Body Leakage	$I_{GSS}$	$V_{DS} = 0\text{ V}, V_{GS} = \pm 20\text{ V}$			$\pm 100$	nA
Zero Gate Voltage Drain Current	$I_{DSS}$	$V_{DS} = 30\text{ V}, V_{GS} = 0\text{ V}$			1	$\mu\text{A}$
		$V_{DS} = 30\text{ V}, V_{GS} = 0\text{ V}, T_J = 125\text{ }^\circ\text{C}$			50	
		$V_{DS} = 30\text{ V}, V_{GS} = 0\text{ V}, T_J = 175\text{ }^\circ\text{C}$			250	
On-State Drain Current <sup>b</sup>	$I_{D(on)}$	$V_{DS} = 5\text{ V}, V_{GS} = 10\text{ V}$	60			A
Drain-Source On-State Resistance <sup>b</sup>	$R_{DS(on)}$	$V_{GS} = 10\text{ V}, I_D = 20\text{ A}$		0.003		$\Omega$
		$V_{GS} = 10\text{ V}, I_D = 20\text{ A}, T_J = 125\text{ }^\circ\text{C}$		0.008		
		$V_{GS} = 10\text{ V}, I_D = 20\text{ A}, T_J = 175\text{ }^\circ\text{C}$		0.010		
		$V_{GS} = 4.5\text{ V}, I_D = 35\text{ A}$		0.004		
Forward Transconductance <sup>b</sup>	$g_{fs}$	$V_{DS} = 15\text{ V}, I_D = 20\text{ A}$		60		S
<b>Dynamic</b>						
Input Capacitance	$C_{iss}$	$V_{GS} = 0\text{ V}, V_{DS} = 100\text{ V}, f = 1\text{ MHz}$		7600		$\mu\text{F}$
Output Capacitance	$C_{oss}$			470		
Reverse Transfer Capacitance	$C_{rss}$			225		
Total Gate Charge <sup>c</sup>	$Q_g$	$V_{DS} = 100\text{ V}, V_{GS} = 10\text{ V}, I_D = 50\text{ A}$		84	70	nC
Gate-Source Charge <sup>c</sup>	$Q_{gs}$			16		
Gate-Drain Charge <sup>c</sup>	$Q_{gd}$			17		
Turn-On Delay Time <sup>c</sup>	$t_{d(on)}$	$V_{DD} = 100\text{ V}, R_L = 0.6\text{ }\Omega$ $I_D \cong 50\text{ A}, V_{GEN} = 10\text{ V}, R_g = 2.5\text{ }\Omega$		20	26	ns
Rise Time <sup>c</sup>	$t_r$			15	25	
Turn-Off Delay Time <sup>c</sup>	$t_{d(off)}$			35	50	
Fall Time <sup>c</sup>	$t_f$			20	30	
<b>Source-Drain Diode Ratings and Characteristics (<math>T_C = 25\text{ }^\circ\text{C}</math>)</b>						
Pulsed Current	$I_{SM}$				405	A
Diode Forward Voltage	$V_{SD}$	$I_F = 20\text{ A}, V_{GS} = 0\text{ V}$		1	1.5	V
Reverse Recovery Time	$t_{rr}$	$I_F = 20\text{ A}, di/dt = 100\text{ A}/\mu\text{s}$		4	135	ns

Notes:

- a. For design aid only; not subject to production testing.
- b. Pulse test; pulse width  $\leq 300\text{ }\mu\text{s}$ , duty cycle  $\leq 2\%$ .
- c. Independent of operating temperature.

Stresses beyond those listed under "Absolute Maximum Ratings" may cause permanent damage to the device. These are stress ratings only, and functional operation of the device at these or any other conditions beyond those indicated in the operational sections of the specifications is not implied. Exposure to absolute maximum rating conditions for extended periods may affect device reliability.

**TYPICAL CHARACTERISTICS** (25 °C unless noted)

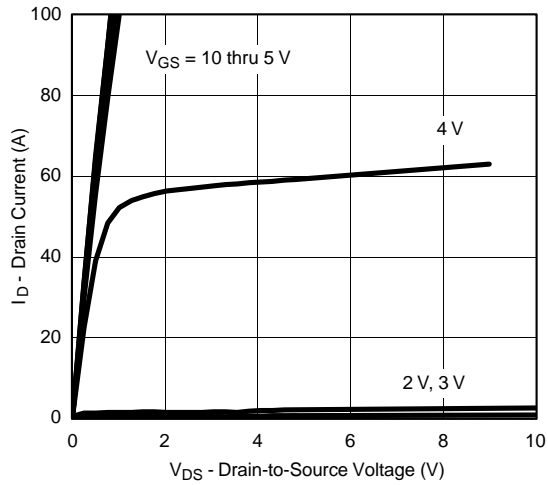

**Output Characteristics**

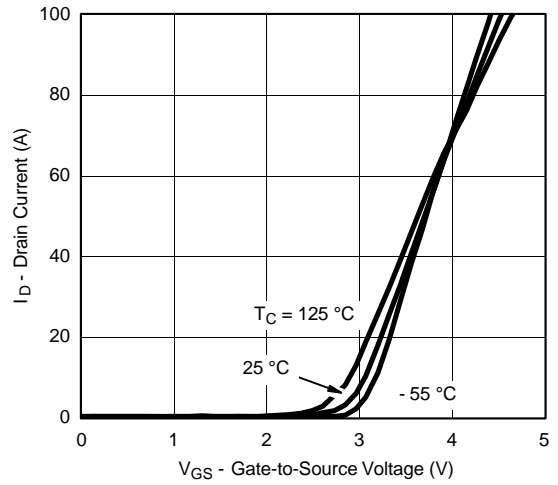

**Transfer Characteristics**

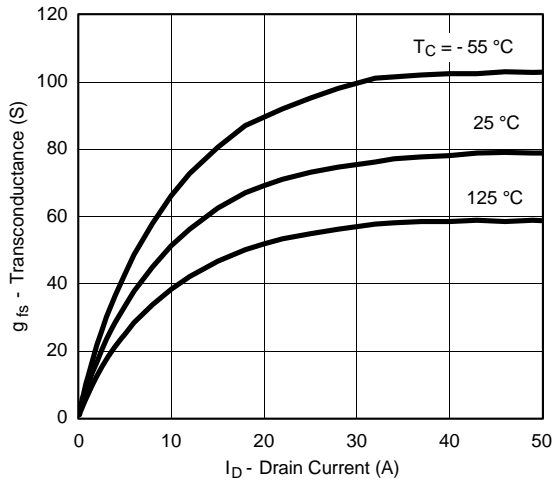

**Transconductance**

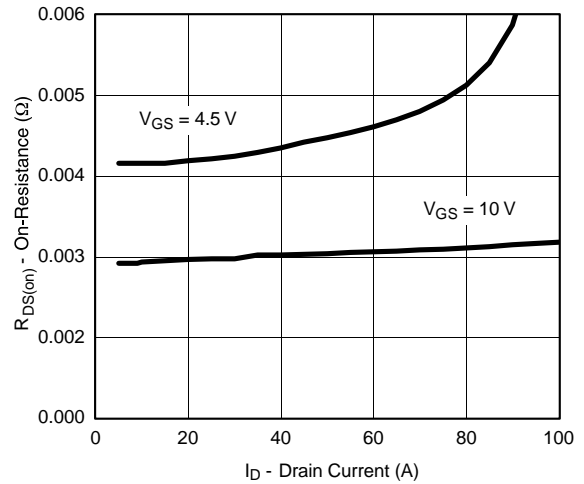

**On-Resistance vs. Drain Current**

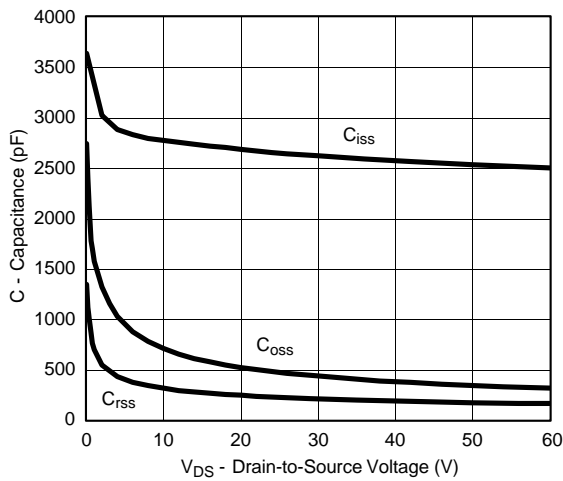

**Capacitance**

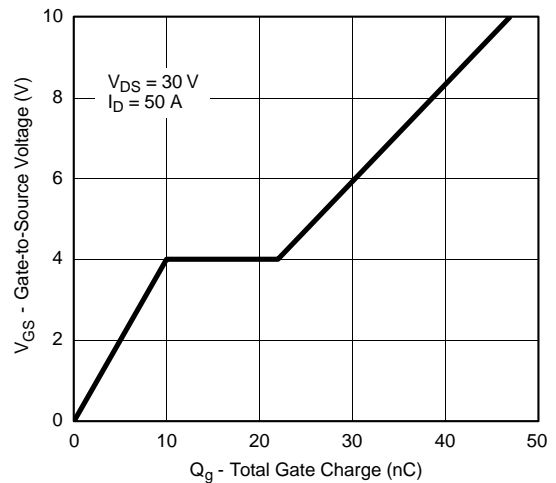

**Gate Charge**

## TYPICAL CHARACTERISTICS (25 °C unless noted)

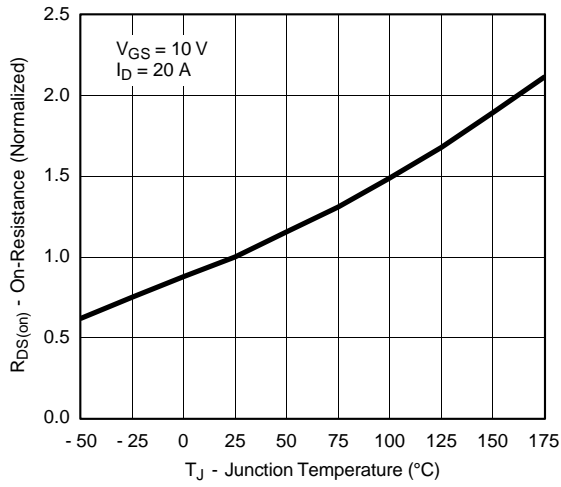

On-Resistance vs. Junction Temperature

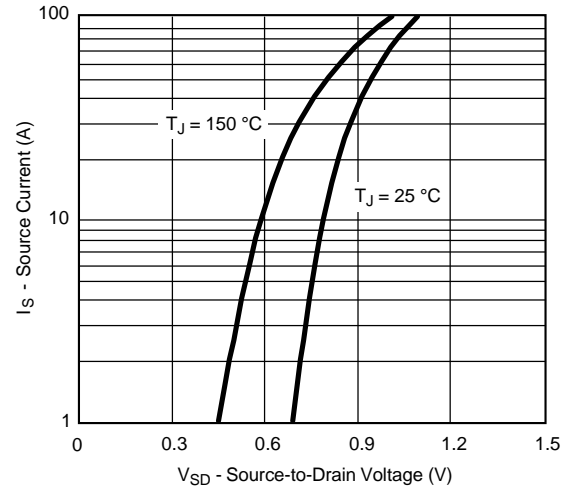

Source-Drain Diode Forward Voltage

**THERMAL RATINGS**

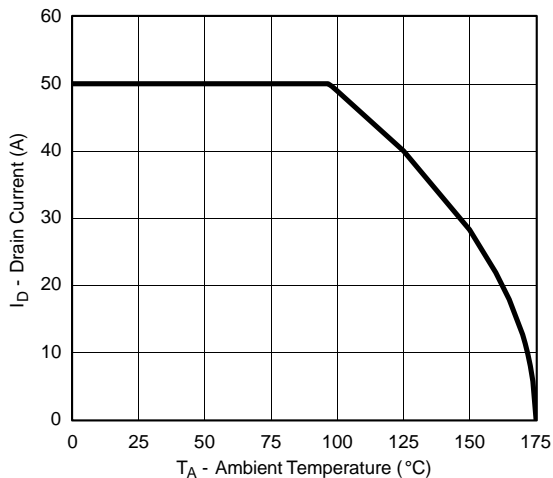

Maximum Drain Current vs. Ambient Temperature

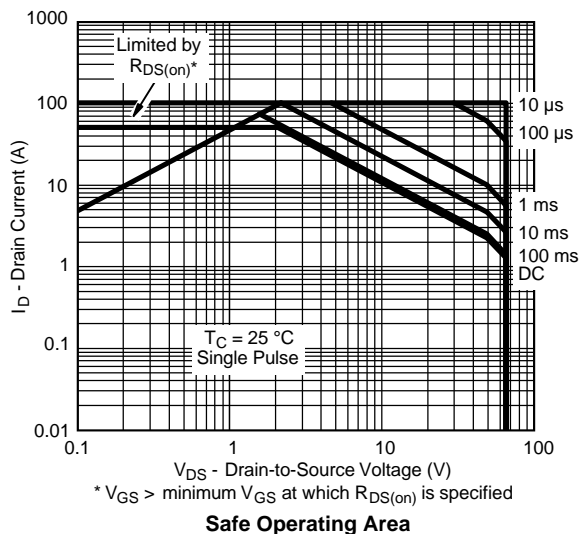

Safe Operating Area

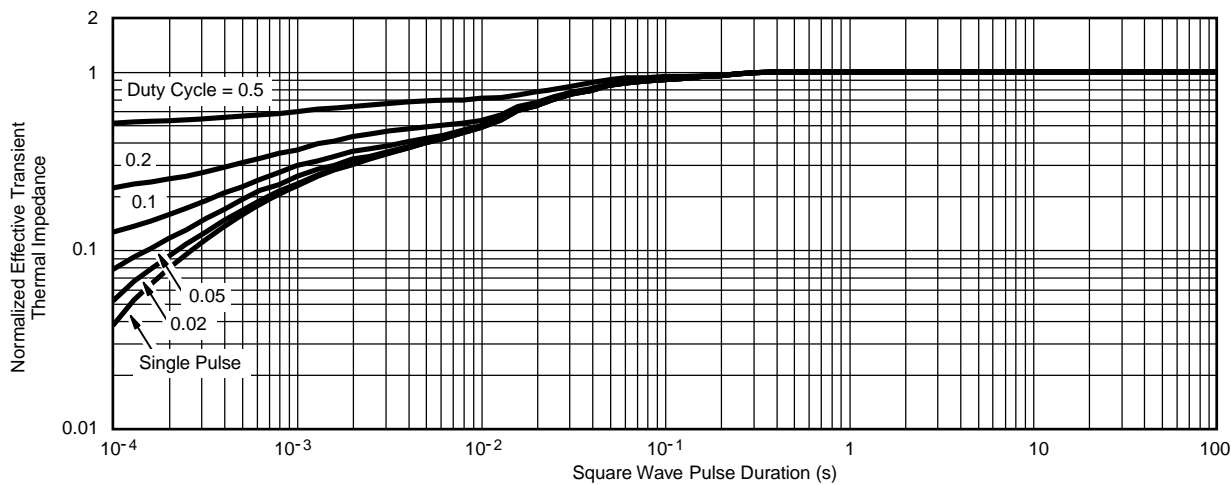

Normalized Thermal Transient Impedance, Junction-to-Case

DFN5x6\_8L\_EP1\_P PACKAGE OUTLIN

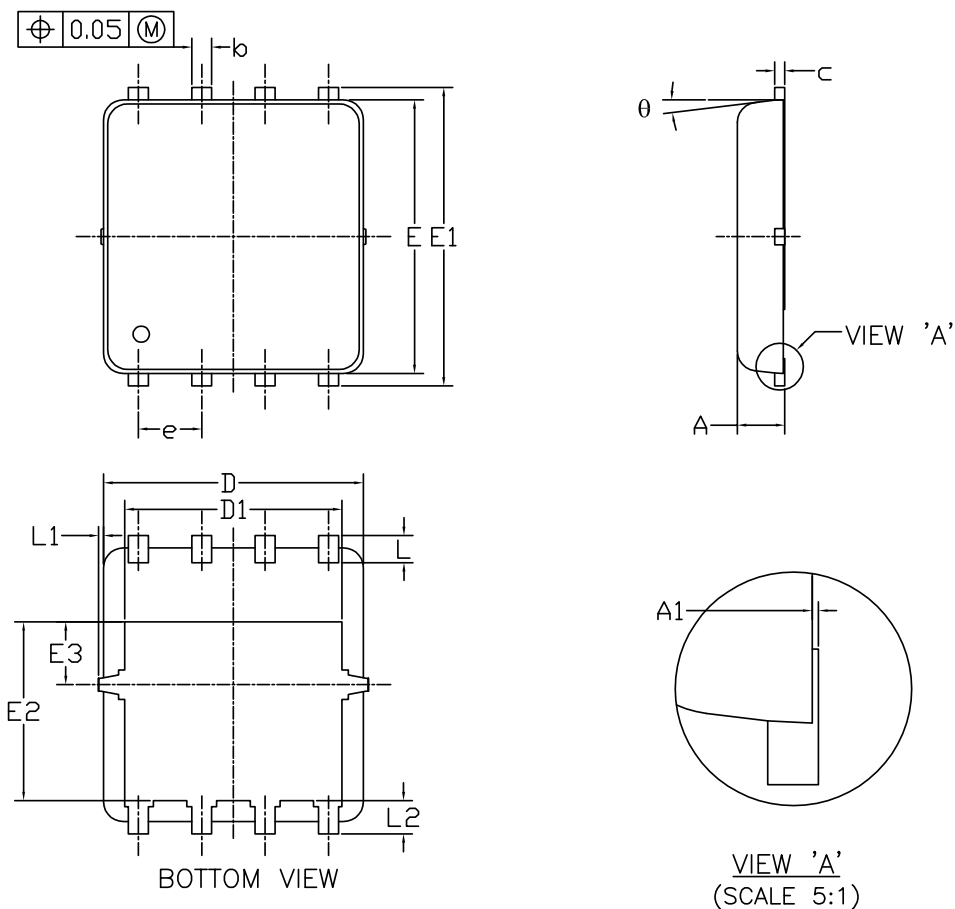

RECOMMENDED LAND PATTERN

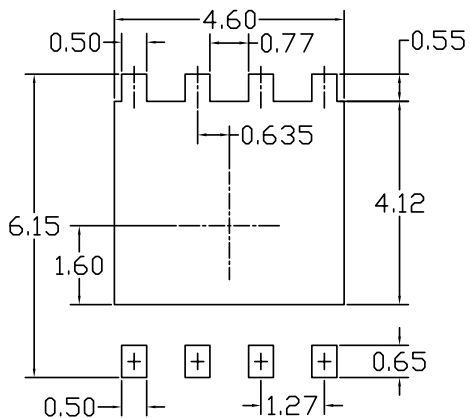

SYMBOLS	DIMENSIONS IN MILLIMETERS			DIMENSIONS IN INCHES		
	MIN	NOM	MAX	MIN	NOM	MAX
A	0.85	0.95	1.00	0.033	0.037	0.039
A1	0.00	---	0.05	0.000	---	0.002
b	0.30	0.40	0.50	0.012	0.016	0.020
c	0.15	0.20	0.25	0.006	0.008	0.010
D	5.10	5.20	5.30	0.201	0.205	0.209
D1	4.25	4.35	4.45	0.167	0.171	0.175
E	5.45	5.55	5.65	0.215	0.219	0.222
E1	5.95	6.05	6.15	0.234	0.238	0.242
E2	3.525	3.625	3.725	0.139	0.143	0.147
E3	1.175	1.275	1.375	0.046	0.050	0.054
e	1.27 BSC			0.050 BSC		
L	0.45	0.55	0.65	0.018	0.022	0.026
L1	0	---	0.15	0	---	0.006
L2	0.68 REF			0.027 REF		
$\theta$	0°	---	10°	0°	---	10°

NOTE

UNIT: mm

- PACKAGE BODY SIZES EXCLUDE MOLD FLASH AND GATE BURRS.  
MOLD FLASH AT THE NON-LEAD SIDES SHOULD BE LESS THAN 6 MILS EACH.
- CONTROLLING DIMENSION IS MILLIMETER.  
CONVERTED INCH DIMENSIONS ARE NOT NECESSARILY EXACT.

# Disclaimer

All products due to improve reliability, function or design or for other reasons, product specifications and data are subject to change without notice.

Taiwan VBsemi Electronics Co., Ltd., branches, agents, employees, and all persons acting on its or their representatives (collectively, the "Taiwan VBsemi"), assumes no responsibility for any errors, inaccuracies or incomplete data contained in the table or any other any disclosure of any information related to the product.(www.VBsemi.com)

Taiwan VBsemi makes no guarantee, representation or warranty on the product for any particular purpose of any goods or continuous production. To the maximum extent permitted by applicable law on Taiwan VBsemi relinquished: (1) any application and all liability arising out of or use of any products; (2) any and all liability, including but not limited to special, consequential damages or incidental ; (3) any and all implied warranties, including a particular purpose, non-infringement and merchantability guarantee.

Statement on certain types of applications are based on knowledge of the product is often used in a typical application of the general product VBsemi Taiwan demand that the Taiwan VBsemi of. Statement on whether the product is suitable for a particular application is non-binding. It is the customer's responsibility to verify specific product features in the products described in the specification is appropriate for use in a particular application. Parameter data sheets and technical specifications can be provided may vary depending on the application and performance over time. All operating parameters, including typical parameters must be made by customer's technical experts validated for each customer application. Product specifications do not expand or modify Taiwan VBsemi purchasing terms and conditions, including but not limited to warranty herein.

Unless expressly stated in writing, Taiwan VBsemi products are not intended for use in medical, life saving, or life sustaining applications or any other application. Wherein VBsemi product failure could lead to personal injury or death, use or sale of products used in Taiwan VBsemi such applications using client did not express their own risk. Contact your authorized Taiwan VBsemi people who are related to product design applications and other terms and conditions in writing.

The information provided in this document and the company's products without a license, express or implied, by estoppel or otherwise, to any intellectual property rights granted to the VBsemi act or document. Product names and trademarks referred to herein are trademarks of their respective representatives will be all.

## Material Category Policy

**Taiwan VBsemi Electronics Co., Ltd., hereby certify that all of the products are determined to be RoHS compliant and meets the definition of restrictions under Directive of the European Parliament 2011/65 / EU, 2011 Nian. 6. 8 Ri Yue restrict the use of certain hazardous substances in electrical and electronic equipment (EEE) - modification, unless otherwise specified as inconsistent.(www.VBsemi.com)**

**Please note that some documents may still refer to Taiwan VBsemi RoHS Directive 2002/95 / EC. We confirm that all products identified as consistent with the Directive 2002/95 / EC European Directive 2011/65 /.**

**Taiwan VBsemi Electronics Co., Ltd. hereby certify that all of its products comply identified as halogen-free halogen-free standards required by the JEDEC JS709A. Please note that some Taiwanese VBsemi documents still refer to the definition of IEC 61249-2-21, and we are sure that all products conform to confirm compliance with IEC 61249-2-21 standard level JS709A.**