

## Description:

This N-Channel MOSFET uses advanced trench technology and design to provide excellent  $R_{DS(on)}$  with low gate charge. It can be used in a wide variety of applications.

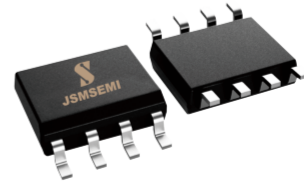

## Features:

- 1)  $V_{DS}=30V, I_D=12A, R_{DS(ON)} < 8m\ \Omega @ V_{GS}=10\ V$
- 2) Low gate charge.
- 3) Green device available.
- 4) Advanced high cell density trench technology for ultra low  $R_{DS(ON)}$ .
- 5) Excellent package for good heat dissipation.

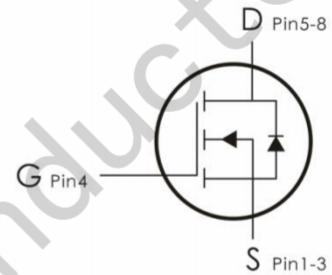

## Absolute Maximum Ratings: ( $T_a=25^\circ\text{C}$ unless otherwise noted)

Symbol	Parameter	Ratings	Units
$V_{DS}$	Drain-Source Voltage	30	V
$V_{GS}$	Gate-Source Voltage	$\pm 20$	V
$I_D$	Continuous Drain Current- $T_A=25^\circ\text{C}$	12	A
	Continuous Drain Current- $T_A=100^\circ\text{C}$	9	
$I_{DM}$	Drain Current-Pulsed <sup>note1</sup>	60	A
$E_{AS}$	Single Pulsed Avalanche Energy <sup>note2</sup>	39	mJ
$P_D$	Power Dissipation	3	W
$T_J, T_{STG}$	Operating and Storage Junction Temperature Range	-55 to +150	$^\circ\text{C}$

## Thermal Characteristics:

Symbol	Parameter	Max	Units
$R_{\theta JA}$	Thermal Resistance, Junction to Ambient	41	$^\circ\text{C}/\text{W}$

**Electrical Characteristics:** ( $T_A=25^{\circ}\text{C}$  unless otherwise noted)

Symbol	Parameter	Conditions	Min	Typ	Max	Units
<b>Off Characteristics</b>						
$BV_{DSS}$	Drain-Source Breakdown Voltage	$V_{GS}=0V, I_D=250\ \mu\text{A}$	30	---	---	V
$I_{DSS}$	Zero Gate Voltage Drain Current	$V_{GS}=0V, V_{DS}=30V$	---	---	1	$\mu\text{A}$
$I_{GSS}$	Gate-Source Leakage Current	$V_{GS}=\pm 20V, V_{DS}=0A$	---	---	$\pm 100$	nA
<b>On Characteristics</b>						
$V_{GS(th)}$	GATE-Source Threshold Voltage	$V_{GS}=V_{DS}, I_D=250\ \mu\text{A}$	1	1.5	2.5	V
$R_{DS(on)}$	Drain-Source On Resistance <sup>note3</sup>	$V_{GS}=10V, I_D=15A$	---	6.5	8	m $\Omega$
		$V_{GS}=4.5V, I_D=10A$	---	10	14	
<b>Dynamic Characteristics</b>						
$C_{iss}$	Input Capacitance	$V_{DS}=15V, V_{GS}=0V, f=1\text{MHz}$	---	1110	---	pF
$C_{oss}$	Output Capacitance		---	180	---	
$C_{rss}$	Reverse Transfer Capacitance		---	150	---	
<b>Switching Characteristics</b>						
$t_{d(on)}$	Turn-On Delay Time	$V_{DS}=15V, I_D=12A$ $R_{GEN}=3\ \Omega, V_{GS}=10V,$	---	15	---	ns
$t_r$	Rise Time		---	19	---	ns
$t_{d(off)}$	Turn-Off Delay Time		---	35	---	ns
$t_f$	Fall Time		---	21	---	ns
$Q_g$	Total Gate Charge	$V_{GS}=10V, V_{DS}=15V,$ $I_D=8A$	---	21	---	nC
$Q_{gs}$	Gate-Source Charge		---	2.35	---	nC
$Q_{gd}$	Gate-Drain "Miller" Charge		---	5.9	---	nC
<b>Drain-Source Diode Characteristics</b>						
$V_{SD}$	Diode Forward Voltage	$V_{GS}=0V, I_S=12A$	---	---	1.2	V
$I_S$	Continuous Drain to Source Diode Forward Current		---	---	12	A

<b>I<sub>SM</sub></b>	Pulsed Drain to Source Diode Forward Current	---	---	60	A
<b>trr</b>	Reverse Recovery Time	I <sub>F</sub> =12A, di/dt=100A/μs	---	14	ns
<b>Qrr</b>	Reverse Recovery Charge		---	4.1	nC

**Notes:**

1. Repetitive Rating: Pulse Width Limited by Maximum Junction Temperature
2. EAS condition: T<sub>J</sub>=25°C, V<sub>GS</sub>=15V, R<sub>G</sub>=25Ω, L=0.5mH, I<sub>AS</sub>=12.6A
3. Pulse Test: Pulse Width≤300μs, Duty Cycle≤0.5%

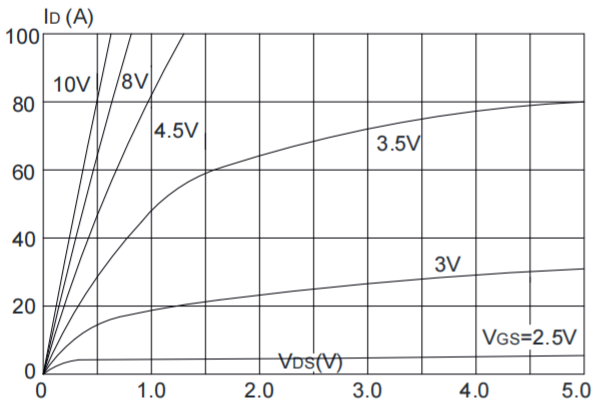
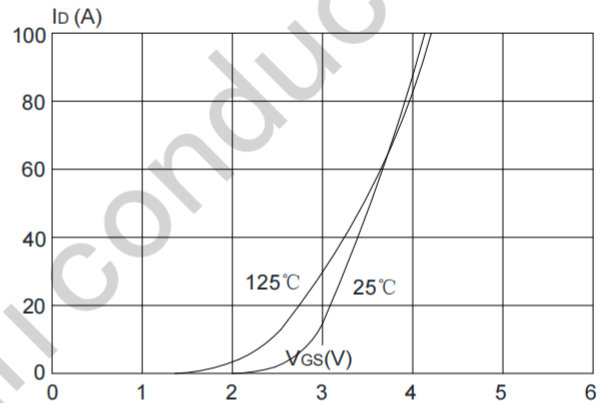
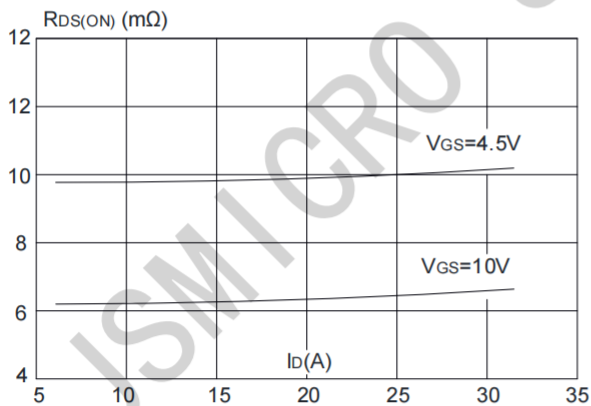
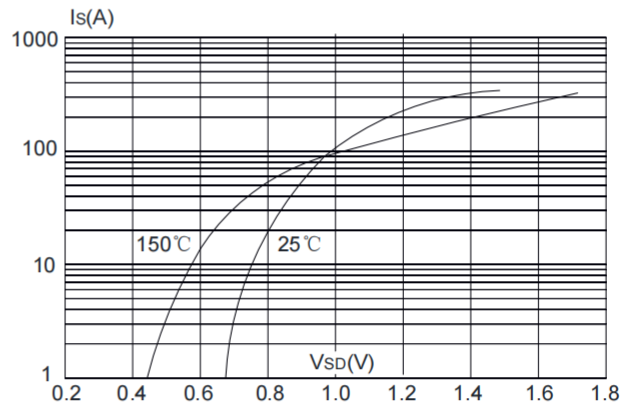
**Typical Characteristics:** (T<sub>C</sub>=25°C unless otherwise noted)

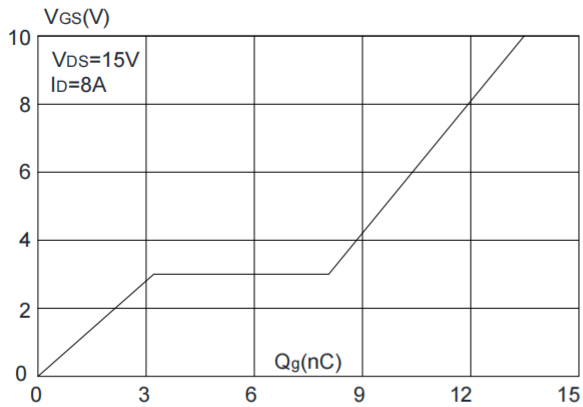
**Figure 1:** Output Characteristics

**Figure 2:** Typical Transfer Characteristics

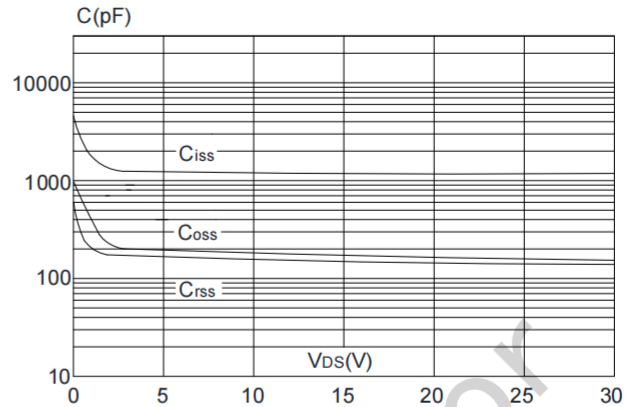
**Figure 3:** On-resistance vs. Drain Current

**Figure 4:** Body Diode Characteristics

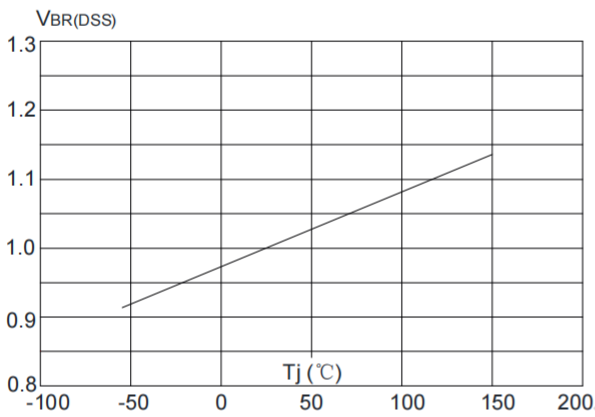

**Figure 5:** Gate Charge Characteristics



**Figure 6:** Capacitance Characteristics



**Figure 7:** Normalized Breakdown Voltage vs. Junction Temperature

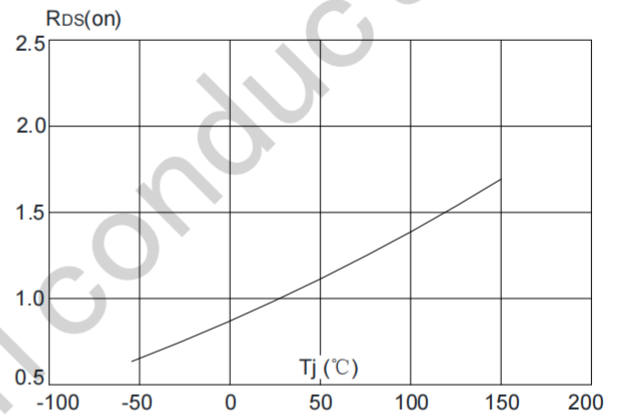

**Figure 8:** Normalized on Resistance vs. Junction Temperature

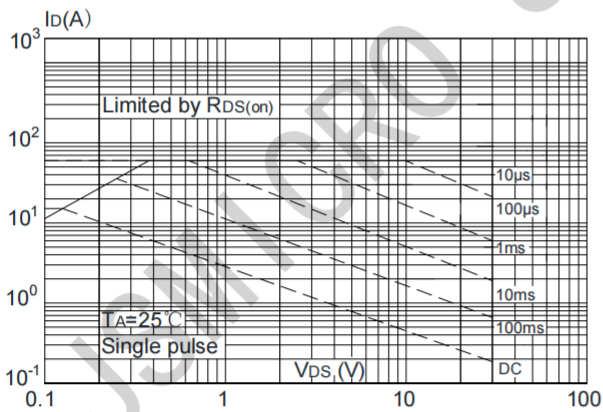

**Figure 9:** Maximum Safe Operating Area

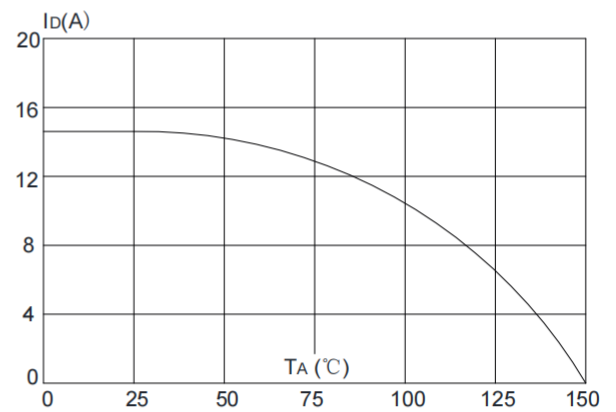

**Figure 10:** Maximum Continuous Drain Current vs. Ambient Temperature

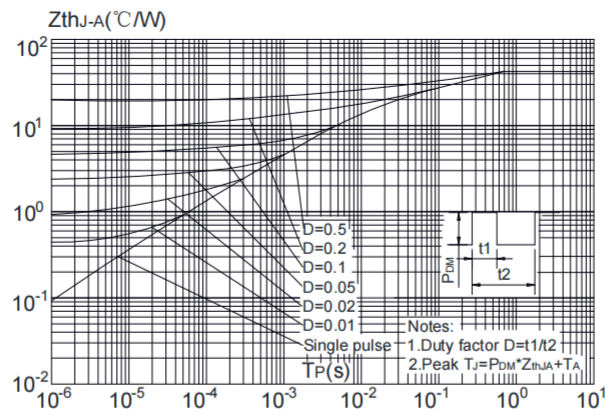
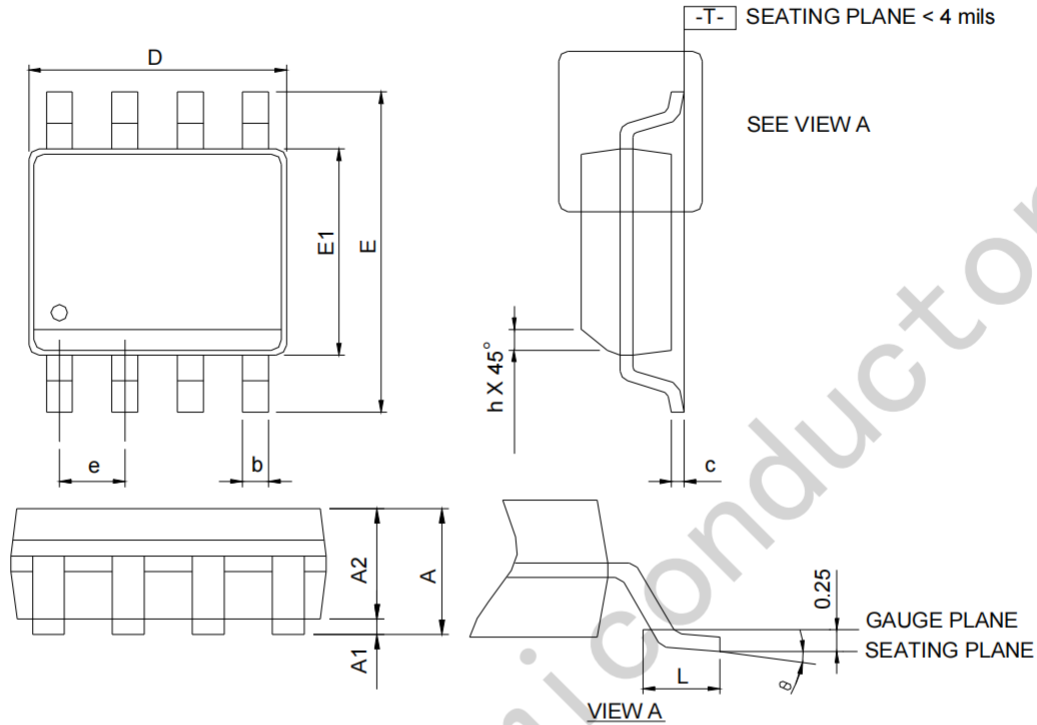

**Figure.11:** Maximum Effective Transient Thermal Impedance, Junction-to-Ambient

JSMICRO Semiconductor

## Package Information

SOP-8



SYMBOLS	SOP-8			
	MILLIMETERS		INCHES	
	MIN.	MAX.	MIN.	MAX.
A	-	1.75	-	0.069
A1	0.10	0.25	0.004	0.010
A2	1.25	-	0.049	-
b	0.31	0.51	0.012	0.020
c	0.17	0.25	0.007	0.010
D	4.80	5.00	0.189	0.197
E	5.80	6.20	0.228	0.244
E1	3.80	4.00	0.150	0.157
e	1.27 BSC		0.050 BSC	
h	0.25	0.50	0.010	0.020
L	0.40	1.27	0.016	0.050
θ	0°	8°	0°	8°

### RECOMMENDED LAND PATTERN

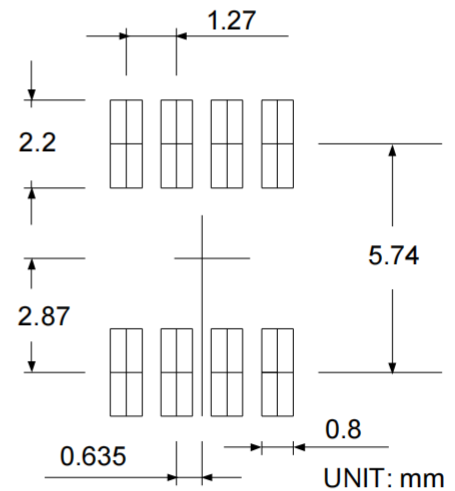

Note: 1. Follow JEDEC MS-012 AA.

2. Dimension "D" does not include mold flash, protrusions or gate burrs. Mold flash, protrusion or gate burrs shall not exceed 6 mil per side.

3. Dimension "E" does not include inter-lead flash or protrusions. Inter-lead flash and protrusions shall not exceed 10 mil per side.