

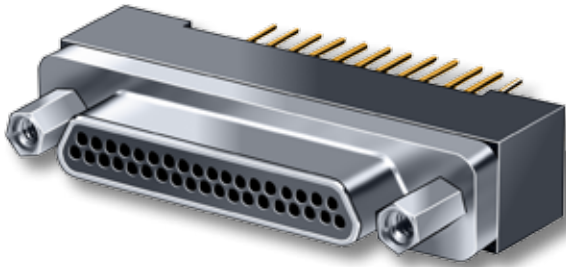

## Micro-D Printed Circuit Board Connectors Condensed Board Straight CBS .075 Inch Spacing



**Save Space On Your Circuit Board**—These Micro-D connectors feature .075 inch row spacing. The board footprint is reduced to match the size of the connector body.

**Designed for Flex Circuits**—CBS COTS connectors are available with jackscrews for flex circuit compatibility.

**Solder-Dipped**—Terminals are coated with SN63/Pb37 tin-lead solder for best solderability. Optional gold-plated terminals are available for RoHS compliance.

**High Performance**—These connectors meet the demanding requirements of MIL-DTL-83513. Suitable for Level 1 NASA reliability.

### HOW TO ORDER CBS CONDENSED BOARD STRAIGHT CONNECTORS

| Series                                | Shell Material and Plating Finish | Insulator Material                                | Number of Contacts              | Contact Type   | Termination Style                                | Hardware Option  | PC Tail Length         | Gold-Plated Terminal Mod Code  |  |   |                                 |  |
|---------------------------------------|-----------------------------------|---|---------------------------------|--|--|--|------------------------|--|--|---|---------------------------------|--|
| <b>MWDM</b><br>Micro-D<br>Metal Shell | Aluminum Shell                    | <b>L</b><br>LCP<br>(Liquid<br>Crystal<br>Polymer) | <b>9</b>                        | <b>P</b><br>Pin  | <b>CBS</b><br><br>Condensed<br>Board<br>Straight | <b>NN</b> –No Jackpost, No<br>Threaded Insert                              | <b>.080</b>            | These<br>connectors are<br>solder-dipped<br>in 63/37 tin-<br>lead solder.<br><br><b>To delete the<br/>solder dip<br/>and change<br/>to gold-plated<br/>terminals,<br/>add code 513</b> |  |   |                                 |  |
|                                       | <b>1</b> – Cadmium                |   | <b>15</b>                       |  |  |  | <b>.110</b>            |  |  |   |                                 |  |
|                                       | <b>2</b> – Nickel                 |   | <b>21</b>                       | <b>S</b><br>Socket   |  | <b>PN</b> –Extended Jackpost for<br>.062" (1.6) PCB, No<br>Threaded Insert | <b>.140</b>            |  |  |   |                                 |  |
|                                       | <b>4</b> – Black Anodize          |   | <b>25</b>                       |  |  |  | <b>.172</b>            |  |  |   |                                 |  |
|                                       | <b>5</b> – Gold                   |   | <b>31</b>                       | <b>RN</b> –Extended Jackpost for<br>.196" (5.0) PCB, No<br>Threaded Insert |  | <b>.190</b>  |                        |  |  |   |                                 |  |
|                                       | <b>6</b> – Chem Film              |   | <b>37</b>                       |  |  | <b>.250</b>  |                        |  |  |   |                                 |  |
|                                       | Stainless Steel Shell             | <b>L</b><br>LCP<br>(Liquid<br>Crystal<br>Polymer) | <b>51</b>                       | <b>S</b><br>Socket   | <b>CBS</b><br><br>Condensed<br>Board<br>Straight | <b>NU</b> –Threaded Insert Only,<br>No Jackposts                           | Length<br>in<br>Inches |  |  |   |                                 |  |
|                                       | <b>3</b> – Passivated             |   | <b>69</b>                       |  |  |  |                        |  | <b>PU</b> –Short Jackpost and<br>Threaded Insert | <b>± .015</b><br>(0.38)                       |                                 |  |
|                                       |                                   |   | <b>100</b>                      |  |  |  |                        |  |  | Rear Panel Jackposts<br>With Threaded Inserts |                                 |  |
|                                       |                                   |   |                                 |  |  |  |                        |  |  |   | <b>R6U</b> – 0.125" (3.2) Panel |  |
|                                       |                                   |   |                                 |  |  |  |                        |  |  |   | <b>R5U</b> – 0.094" (2.4) Panel |  |
|                                       |                                   |   |                                 |  |  |  |                        |  |  |   | <b>R4U</b> – 0.062" (1.6) Panel |  |
|                                       |                                   |   | <b>R3U</b> – 0.047" (1.2) Panel |  |  |  |                        |  |  |   |                                 |  |
|                                       |                                   |   | <b>R2U</b> – 0.031" (0.8) Panel |  |  |  |                        |  |  |   |                                 |  |
|                                       |                                   |   |                                 | <b>Jackscrew Options</b>   |  |  |                        |  |  |   |                                 |  |
|                                       |                                   |   |                                 | <b>M</b> – Hex Head Jackscrews   |  |  |                        |  |  |   |                                 |  |
|                                       |                                   |   |                                 | <b>S</b> – Slot Head Jackscrews  |  |  |                        |  |  |   |                                 |  |

Sample Part Number

MWDM 1 L - 31 P CBS NN - .110

**HARDWARE OPTIONS**  
See Pages C-16 and C-17

# Micro-D Printed Circuit Board Connectors Condensed Board Straight CBS .075 Inch Spacing



Micro-D  
PCB

## PERFORMANCE SPECIFICATIONS

|                           |                               |
|---------------------------|-------------------------------|
| Current Rating            | 3 AMP                         |
| DWV                       | 600 VAC Sea level             |
| Insulation Resistance     | 5000 Megohms Minimum          |
| Contact Resistance        | 8 Milliohms Maximum           |
| Low Level Contact Resist. | 32 Milliohms Maximum          |
| Magnetic Permeability     | 2 $\mu$ Maximum               |
| Operating Temperature     | -55° C. to +150° C.           |
| Shock, Vibration          | 50 g., 20g.                   |
| Mating Force              | (10 Ounces) X (# of Contacts) |

## MATERIALS AND FINISHES

|                  |   |
|------------------|---|
| Connector Shell  | Aluminum Alloy 6061 or Stainless Steel, 300 Series, passivated. See Ordering Info for Plating Options |
| Insulator, Tray  | Liquid Crystal Polymer (LCP)  |
| Interfacial Seal | Fluorosilicone Rubber, Blue   |
| Pin Contact      | Copper Alloy, Gold over Nickel Plating  |
| Socket Contact   | Copper Alloy, Gold Over Nickel Plating  |
| PCB Terminals    | Gold Plated Copper Alloy, Solder Dipped   |
| Hardware         | 300 Series Stainless Steel  |
| Encapsulant      | Epoxy Resin Hysol EE4215  |

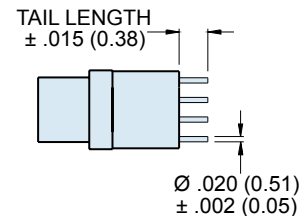
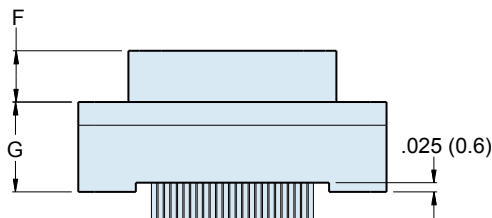
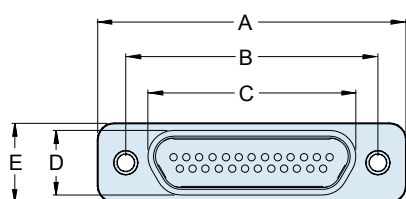

## MICRO-D CBS BOARD MOUNT CONNECTOR DIMENSIONS

| Layout | A Max. |       | B            |              | C Max. |       | D Max. |      | E Max. |       | F            |              | G Max. |       |
|--------|--------|-------|--------------|--------------|--------|-------|--------|------|--------|-------|--------------|--------------|--------|-------|
|        | In.    | mm.   | In.<br>±.005 | mm.<br>±0.13 | In.    | mm.   | In.    | mm.  | In.    | mm.   | In.<br>±.003 | mm.<br>±.008 | In.    | mm.   |
| 9P     | .785   | 19.94 | .565         | 14.35        | .333   | 8.46  | .184   | 4.67 | .310   | 7.87  | .183         | 4.65         | .355   | 9.02  |
| 9S     | .785   | 19.94 | .565         | 14.35        | .400   | 10.16 | .250   | 6.35 | .310   | 7.87  | .195         | 4.95         | .355   | 9.02  |
| 15P    | .935   | 23.75 | .715         | 18.16        | .483   | 12.27 | .184   | 4.67 | .310   | 7.87  | .183         | 4.65         | .355   | 9.02  |
| 15S    | .935   | 23.75 | .715         | 18.16        | .551   | 14.00 | .250   | 6.35 | .310   | 7.87  | .195         | 4.95         | .355   | 9.02  |
| 21P    | 1.085  | 27.56 | .865         | 21.97        | .633   | 16.08 | .184   | 4.67 | .310   | 7.87  | .183         | 4.65         | .355   | 9.02  |
| 21S    | 1.085  | 27.56 | .865         | 21.97        | .701   | 17.81 | .250   | 6.35 | .310   | 7.87  | .195         | 4.95         | .355   | 9.02  |
| 25P    | 1.185  | 30.01 | .965         | 24.51        | .733   | 18.62 | .184   | 4.67 | .310   | 7.87  | .183         | 4.65         | .355   | 9.02  |
| 25S    | 1.185  | 30.01 | .965         | 24.51        | .801   | 20.35 | .250   | 6.35 | .310   | 7.87  | .195         | 4.95         | .355   | 9.02  |
| 31P    | 1.335  | 33.91 | 1.115        | 28.32        | .883   | 22.43 | .184   | 4.67 | .310   | 7.87  | .183         | 4.65         | .355   | 9.02  |
| 31S    | 1.335  | 33.91 | 1.115        | 28.32        | .951   | 24.16 | .250   | 6.35 | .310   | 7.87  | .195         | 4.95         | .355   | 9.02  |
| 37P    | 1.485  | 37.72 | 1.265        | 32.13        | 1.033  | 26.24 | .184   | 4.67 | .310   | 7.87  | .183         | 4.65         | .355   | 9.02  |
| 37S    | 1.485  | 37.72 | 1.265        | 32.13        | 1.101  | 27.96 | .250   | 6.35 | .310   | 7.87  | .195         | 4.95         | .355   | 9.02  |
| 51P    | 1.435  | 36.45 | 1.215        | 30.86        | .983   | 24.97 | .228   | 5.79 | .400   | 10.16 | .183         | 4.65         | .355   | 9.02  |
| 51S    | 1.435  | 36.45 | 1.215        | 30.86        | 1.051  | 26.70 | .296   | 7.52 | .400   | 10.16 | .195         | 4.95         | .355   | 9.02  |
| 69P    | 1.735  | 44.07 | 1.515        | 38.48        | 1.284  | 32.61 | .224   | 5.69 | .400   | 10.16 | .183         | 4.65         | .355   | 9.02  |
| 69S    | 1.735  | 44.07 | 1.515        | 38.48        | 1.350  | 34.29 | .293   | 7.44 | .400   | 10.16 | .195         | 4.95         | .355   | 9.02  |
| 100P   | 2.170  | 55.12 | 1.800        | 45.72        | 1.383  | 35.13 | .270   | 6.86 | .510   | 12.95 | .183         | 4.65         | .430   | 10.92 |
| 100S   | 2.170  | 55.12 | 1.800        | 45.72        | 1.451  | 36.86 | .333   | 8.46 | .510   | 12.95 | .195         | 4.95         | .430   | 10.92 |



# Micro-D Printed Circuit Board Connectors Condensed Board Straight CBS .075 Inch Spacing

## MICRO-D CBS BOARD MOUNT CONNECTOR HARDWARE OPTIONS

C

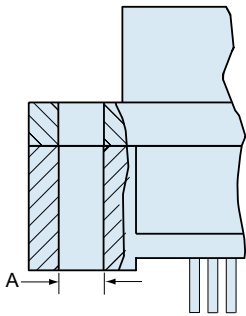

A DIAMETER  
9-69 CONTACTS  
.096/.088 (2.44/2.24)  
100 CONTACTS  
.150/.145 (3.81/3.68)

**NN Style**  
Thru-Hole, No Hardware

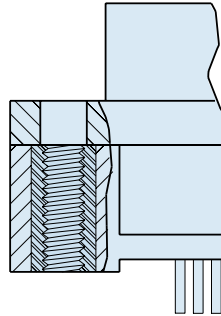

9-69 CONTACTS  
NO. 2-56 UNC-2B  
100 CONTACTS  
NO. 4-40 UNC-2B

**NU Style**  
Threaded Insert

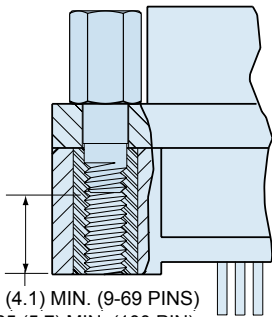

.160 (4.1) MIN. (9-69 PINS)  
.225 (5.7) MIN. (100 PIN)

**PU Style**  
Jackpost with Threaded Insert

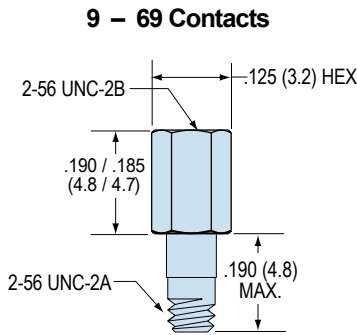

Kit Part Number **500-063-1**  
Kit Consists of Two Jackposts

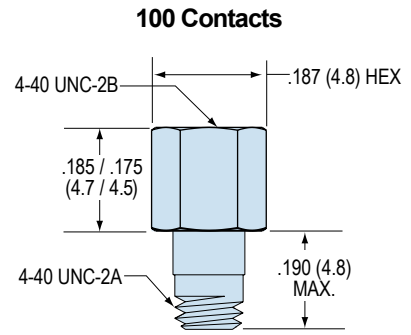

Kit Part Number **500-063-2**  
Kit Consists of Two Jackposts

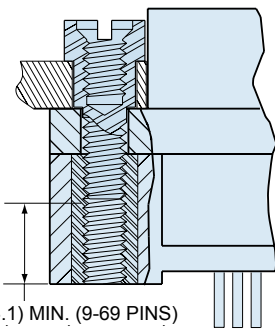

.160 (4.1) MIN. (9-69 PINS)  
.225 (5.7) MIN. (100 PIN)

**RU Style**  
Jackpost For Rear Panel  
Mounting, with Threaded Insert

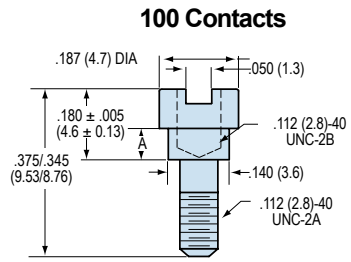
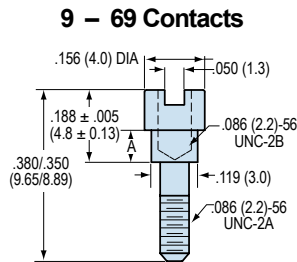

| Hardware Option | Panel Thickness | Part Number   | A ± .003 (0.08) | Hardware Option | Panel Thickness | Part Number   | A ± .003 (0.08) |
|-----------------|-----------------|---------------|-----------------|-----------------|-----------------|---------------|-----------------|
| R2U             | 1/32 (0.8)      | 177-505-A-2-2 | .024 (0.6)      | R2U             | 1/32 (0.8)      | 177-505-D-4-2 | .024 (0.6)      |
| R3U             | 3/64 (1.2)      | 177-505-A-2-3 | .041 (1.0)      | R3U             | 3/64 (1.2)      | 177-505-D-4-3 | .041 (1.0)      |
| R4U             | 1/16 (1.6)      | 177-505-A-2-4 | .055 (1.4)      | R4U             | 1/16 (1.6)      | 177-505-D-4-4 | .055 (1.4)      |
| R5U             | 3/32 (2.4)      | 177-505-A-2-5 | .086 (2.2)      | R5U             | 3/32 (2.4)      | 177-505-D-4-5 | .086 (2.2)      |
| R6U             | 1/8 (3.2)       | 177-505-A-2-6 | .118 (3.0)      | R6U             | 1/8 (3.2)       | 177-505-D-4-6 | .118 (3.0)      |

# Micro-D Printed Circuit Board Connectors Condensed Board Straight CBS .075 Inch Spacing



Micro-D  
PCB

## MICRO-D CBS BOARD MOUNT CONNECTOR HARDWARE OPTIONS

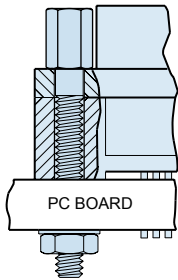

**PN Style** for .062" PCB  
**RN Style** for .196" PCB  
Jackpost Kit

### 9 - 69 Contacts

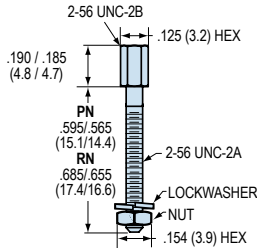

PN Kit Part Number **500-069-2-6**  
RN Kit Part Number **500-069-2-7**  
Kit Consists of 2 Jackposts, 2 Nuts, 2 Washers

### 100 Contacts

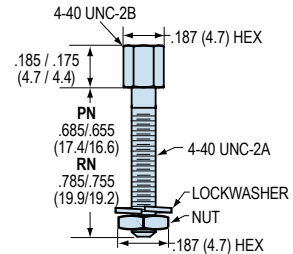

PN Kit Part Number **500-069-4-7**  
RN Kit Part Number **500-069-4-8**  
Kit Consists of 2 Jackposts, 2 Nuts, 2 Washers

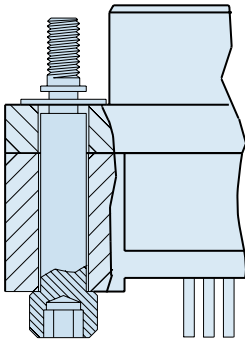

**M Style**  
Hex Head Jackscrew with  
E-Ring

### 9 - 69 Contacts

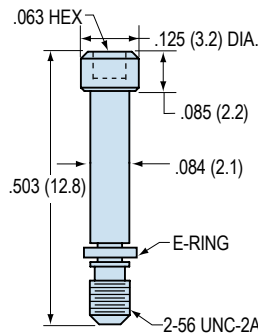

Kit Part Number **500-080-2**  
Kit Consists of 2 Jackscrews and 2 E-Rings

### 100 Contacts

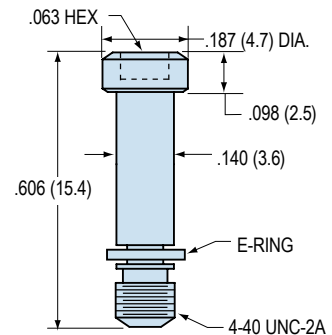

Kit Part Number **500-080-4**  
Kit Consists of 2 Jackscrews and 2 E-Rings

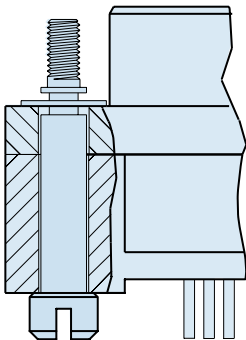

**S Style**  
Slot Head Jackscrew with  
E-Ring

### 9 - 69 Contacts

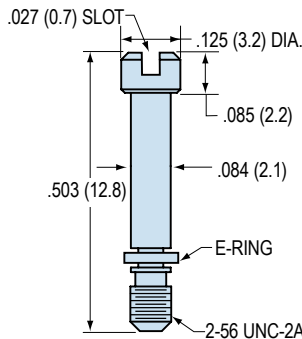

Kit Part Number **500-081-2**  
Kit Consists of 2 Jackscrews and 2 E-Rings

### 100 Contacts

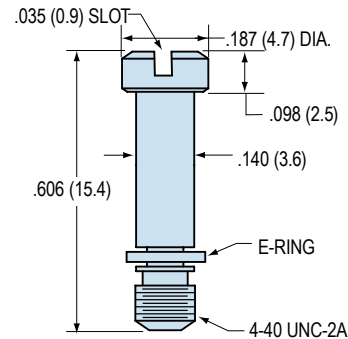

Kit Part Number **500-081-4**  
Kit Consists of 2 Jackscrews and 2 E-Rings

Patterns shown are for connector mounting side of PC board.

## MICRO-D CBS BOARD MOUNT CONNECTOR PCB LAYOUTS – PIN CONNECTORS

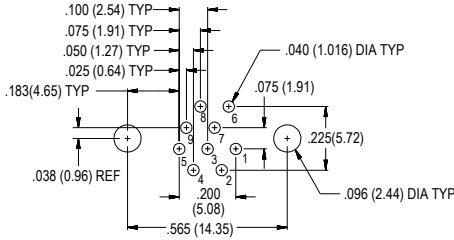

9 PIN MWDM-9PCBS

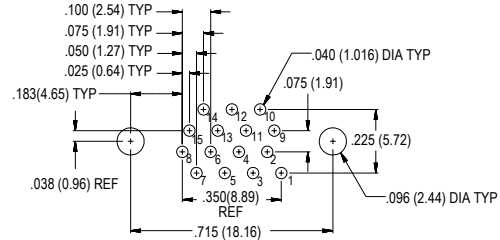

15 PIN MWDM-15PCBS

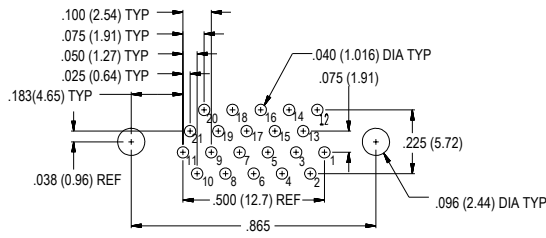

21 PIN MWDM-21PCBS

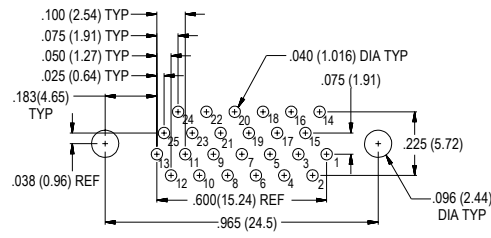

25 PIN MWDM-25PCBS

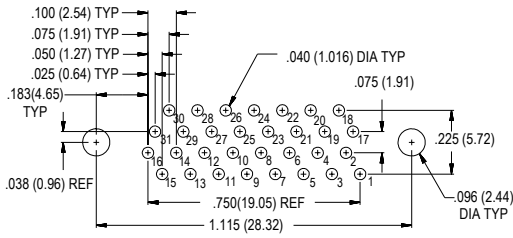

31 PIN MWDM-31PCBS

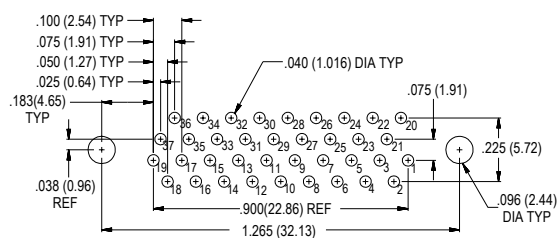

37 PIN MWDM-37PCBS

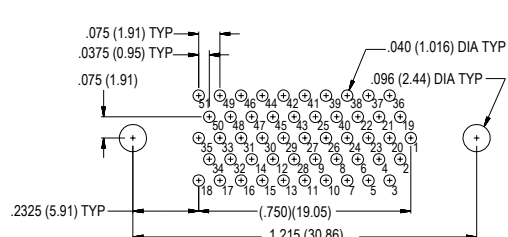

51 PIN MWDM-51PCBS

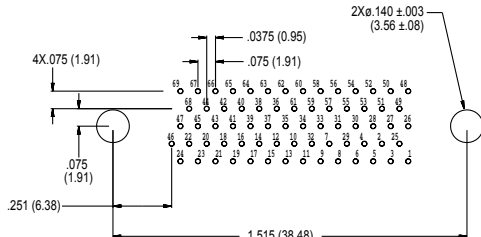

69 PIN MWDM-69PCBS

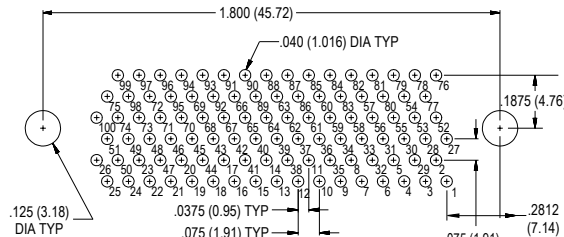

100 PIN MWDM-100PCBS

# Micro-D Printed Circuit Board Connectors Condensed Board Straight CBS .075 Inch Spacing



Micro-D  
PCB

Patterns shown are for connector mounting side of PC board.

## MICRO-D CBS BOARD MOUNT CONNECTOR PCB LAYOUTS – SOCKET CONNECTORS

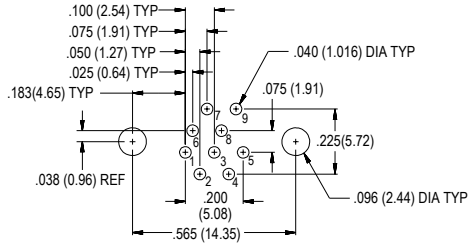

9 Socket MWDM-9SCBS

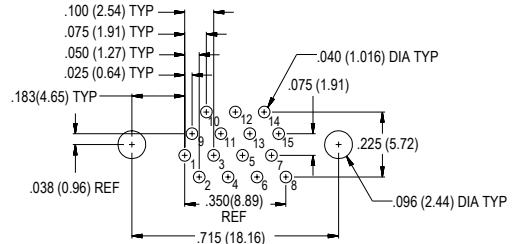

15 Socket MWDM-15SCBS

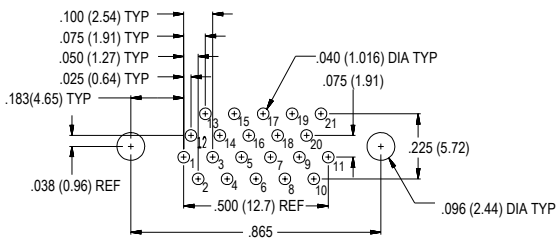

21 Socket MWDM-21SCBS

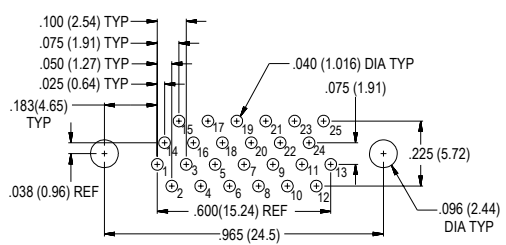

25 Socket MWDM-25SCBS

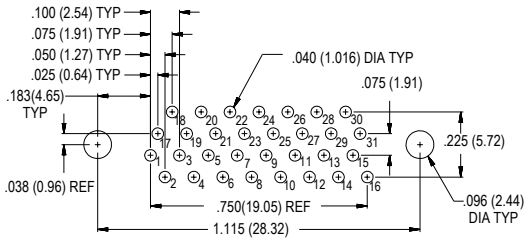

31 Socket MWDM-31SCBS

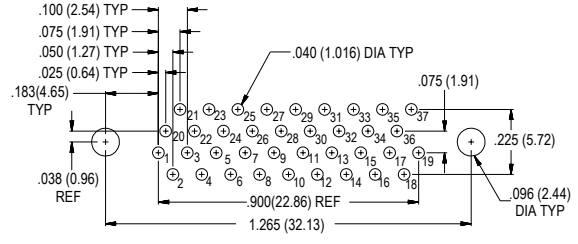

37 Socket MWDM-37SCBS

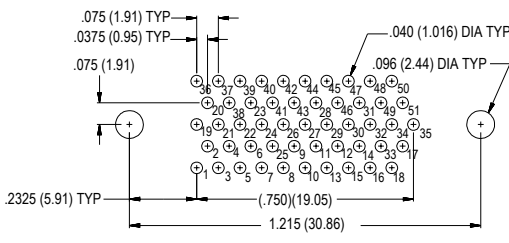

51 Socket MWDM-51SCBS

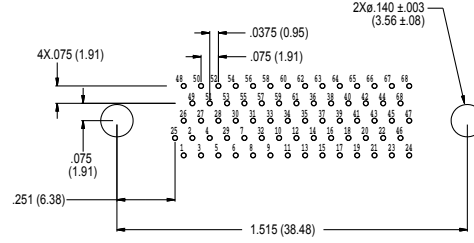

69 Socket MWDM-69SCBS

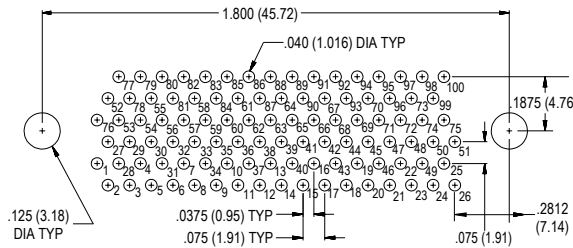

100 Socket MWDM-100SCBS