

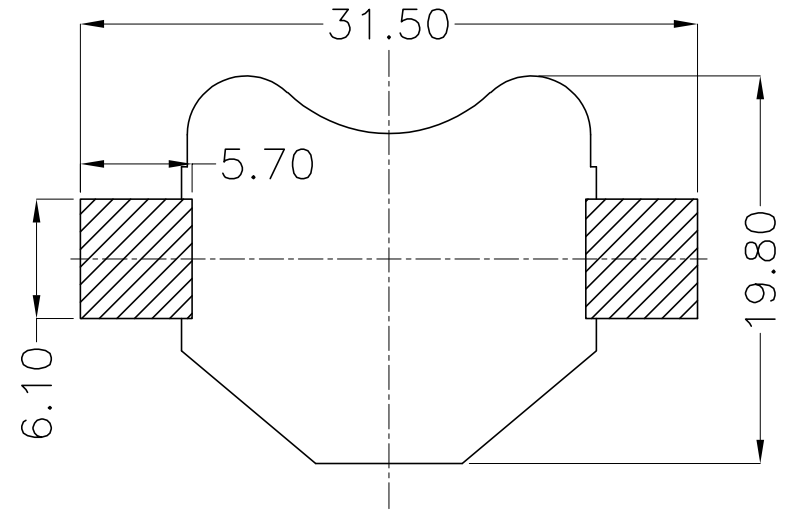

REV.	ECN NO.	REVISED	DATE

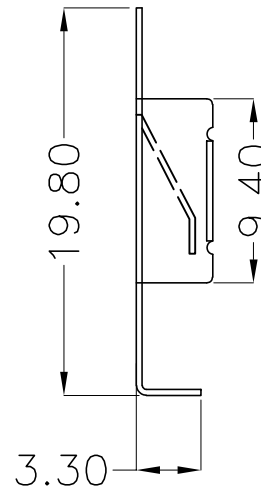

PCB Layout Diagram
Top View

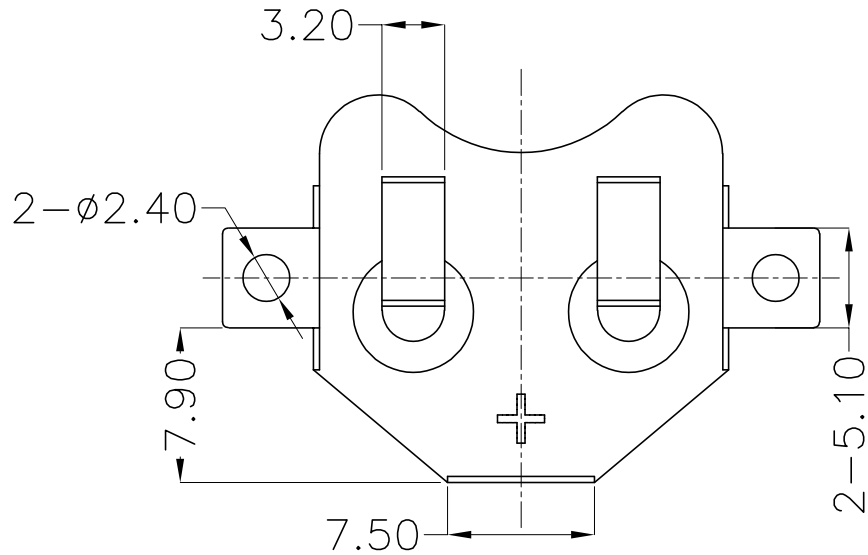
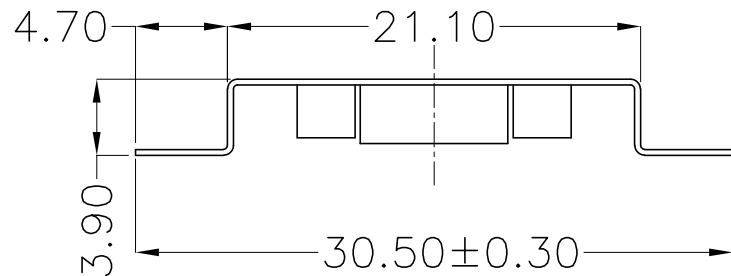

工程部
2024-01-18
LQ. HUANG

UNLESS OTHERWISE SPECIFIED TOLERANCES		MYOUNG 美用 www.meiyangdz.com	
DECIMALS: X :±0.30 X.X :±0.25 X.XX :±0.20 X.XXX :±0.10	ANGLES: X :±1° X.X :±0.5°	DSND HuangLieQing	DATE 2024-01-18
		CHKD ZhouRuicai	DATE 2024-01-18
		APVD XueShunYong	DATE 2024-01-18
WEIGHT:1.02g		SCALE:2.5:1	SIZE: A4
SHEET 1 OF 2		UNIT: mm	REV.: A/0
		VIEW:	OBJECT: MY
		TITLE: 电池扣CR2032-W SMT 卷装	
		PART NO.: MY-2032-04-R	
		DRAW NO.:MY-CP-0157	

1	TERMINAL(+)	1	PHOSPHOR BRONZE, T=0.30mm	Ni-Plating
NO.	PART NAME	Q'TY	MATERIAL	PLATING & COLOR

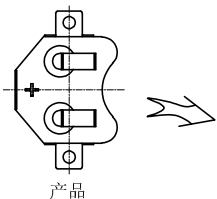

产品

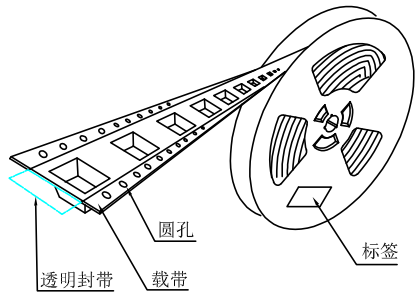

圆孔

透明封带

载带

标签

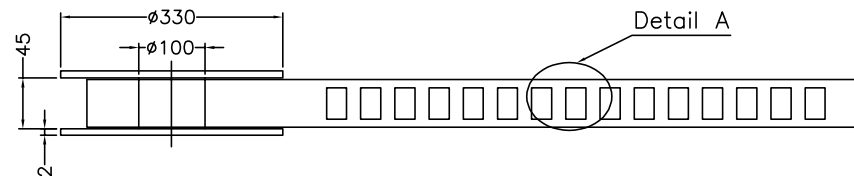

Detail A

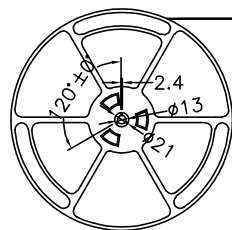

出料方向

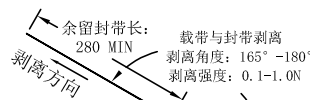

剥离方向

载带与封带剥离
剥离角度: 165° -180°
剥离强度: 0.1-1.0N

12空穴 共封装 500 只产品 12空穴
末端留空穴载带 前端留空穴载带

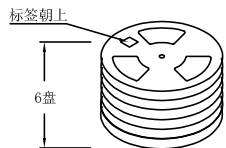

标签朝上

6盘

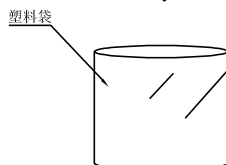

塑料袋

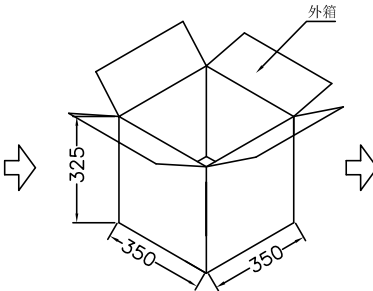

外箱

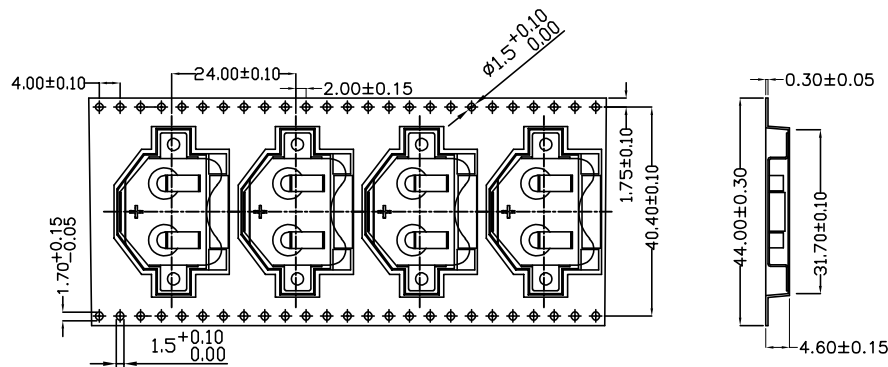
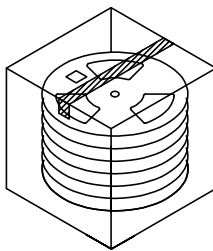

Detail A

技术要求:

1. 圆孔十个孔距离累计允许公差为±0.2mm
2. 带长250mm内容许弯曲度1mm
3. 材料厚度以在载带边缘测量为准
4. 所有尺寸定义依循EIA-481-C系准则定义之
5. 材料: 黑色PS T=0.30mm
6. 所有卷轮为灰蓝挖空旋转塑胶卷轮
7. 整模成型长度: 12.576M,
8. 非指明公差范围为: ±0.1mm; 超过250mm不计算累计误差
9. 型腔外形凡未标明处倒角R为0.2-0.3; 拔模斜度未标注的为3° 以下

包装信息:

- 1、每卷盘装产品 500 只, 卷盘外侧贴相关标签;
- 2、每 6 卷盘放在一个塑料袋中;
- 3、每外箱装6盘, 产品总数: 3000 只;
- 4、外箱上下用胶纸封成“工”字;
- 5、电池扣包材CR2032-W SMT 卷装 (MY-2032-W-01-R)



UNLESS OTHERWISE SPECIFIED TOLERANCES		MYOUNG 美阳 www.meiyangdz.com			
DECIMALS: X : ±*** X.X : ±*** X.XX : ±*** X.XXX : ±***	ANGLES: X : ±*** X.X : ±***	DSND	WangHeng	DATE	2021-11-18
		CHKD	ZhouRuicai	DATE	2021-11-18
		APVD	XueShun Yong	DATE	2021-11-18
WEIGHT:		SCALE:	SIZE: A4	VIEW:	⊙ ⊞
SHEET 2 OF 2		UNIT: mm	REV.: A/0	OBJECT: MY	TITLE: 电池扣CR2032-W SMT 卷装
		PART NO.:			MY-2032-04-R
		DRAW NO.:			MY-BD-0014