



深圳市钜硕电子有限公司
SHENZHEN JUSHUO ELECTRONICS CO., LTD

承认书

SPECIFICATIONS FOR APPROVAL

客 户:

CUSTOMER:

品 名:

DESCRIPTION:

TYPE-C 16Pin母座双排立贴 长度10.)mm

料 号:

PART NO:

JS16L-TYPE-C42(-H10)

承 认 印 ACKNOWLEDGMENT SEAL

客 户 确 认 CUSTOMER APPROVAL		本 司 确 认 TRX APPROVAL		
核 准 APPROVAL		核 准 APPROVAL	贺 文 超	
工 程 PROJECT		工 程 PROJECT	吴 佩 隽	
品 保 Q A		品 保 Q A	王 成 铎	

◎ 联 系 人:

CONTACT PERSON

◎ 公 司 电 话: 0755-27220896

COMPANY TELEGRAMS

◎ 公 司 地 址: 广东省深圳市松岗镇下山门钜硕工业园

COMPANY ADDRESS

◎ 公 司 官 网: <http://www.jushuo.net.cn>

COMPANY WEBSITE

◎ 手 机:

MOBILE PHONE

◎ 邮 箱: jushuo518@163.com

E-MAIL

RoHs

VER	MARK	PR. BY	ECR/ECN	DESCRIPTION	DATE
A		程玉红		NEW RELEASE	10/24' 20

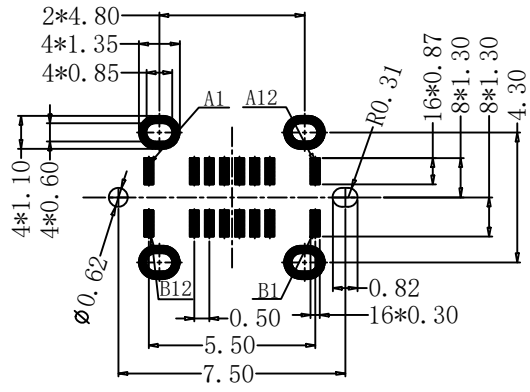
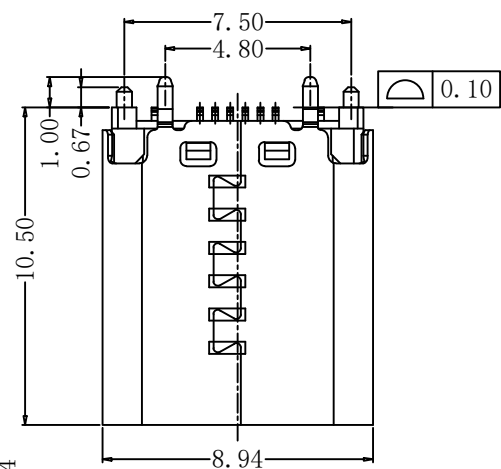

(TOP VIEW)
RECOMMENDED P.C.B. LAYOUT (T:0.8mm)
TOLERANCE UNSPECIFIED ±0.05mm

- SPECIFICATION:
- MATERIAL & FINISH:SEE THE LIST;
 - PLATING SPECIFICATION:
 - CONTACTS:
 - Ni 50u" MIN. UNDER PLATED OVER ALL.
 - Au PLATED ON THE MATING AREA OF CONTACT.
 - Au PLATED ON THE SOLDER AREA.
 - SHELL: Ni 30u" MIN. UNDER PLATED OVER ALL.
 - MID PLATE: CLEAR ONLY
 - MECHANICAL:
 - MATING FORCE: 0.5~2.0kgf;
 - UNMATING FORCE: 0.8~2.0kgf.
 - DURABILITY: 10000 CYCLES;
 - ELECTRICAL:
 - CURRENT RATING: 5A Max;
 - VOLTAGE RATING: 20V Max;
 - DIELECTRIC WITHSTANDING VOLTAGE: 100VAc;
 - CONTACT RESISTANCE: 40mΩ Ohms Max.;
 - INSULATION RESISTANCE: 100M Ohms Min.;
 - ENVIRONMENTAL:
 - OPERATING TEMPERATURE: -40° C~+85° C;
 - WETTING TEMPERATURE: 265±5° C, 5±0.5s
 - Salt Spray Test: 48H Min

PIN	SIGNAL	PIN	SIGNAL
A12	GND	B1	GND
A11	—	B2	—
A10	—	B3	—
A9	VBUS	B4	VBUS
A8	SBU1	B5	CC2
A7	D-	B6	D+
A6	D+	B7	D-
A5	CC1	B8	SBU2
A4	VBUS	B9	VBUS
A3	—	B10	—
A2	—	B11	—
A1	GND	B12	GND

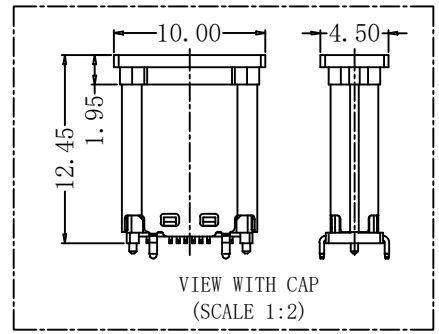
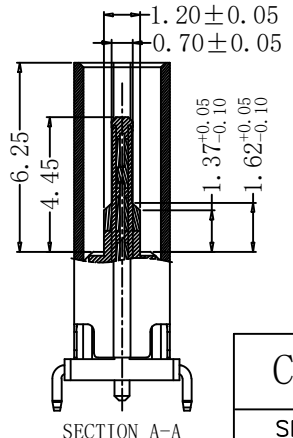
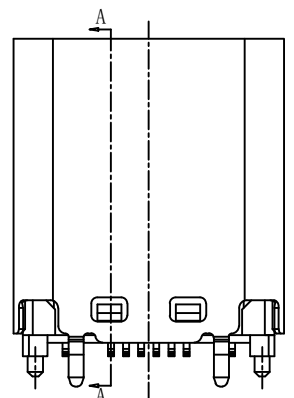
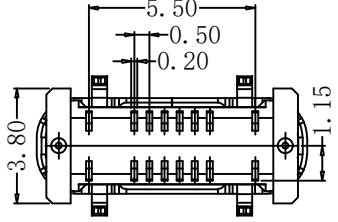
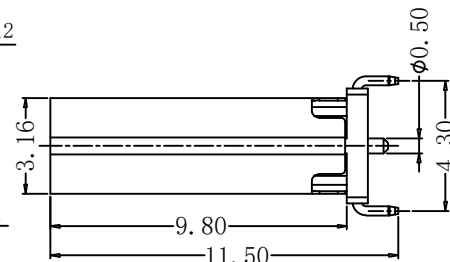
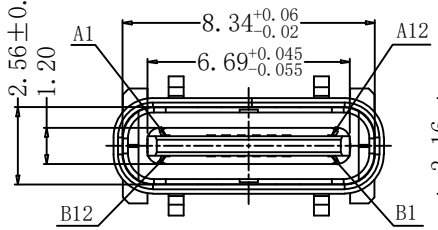

NO.	PART NAME	Q' TY	MATERIAL	FINISH
5	CAP	1	High temperature plastic	UL94 V-0, Black
4	Shell	1	SUS304-1/2H, T=0.30mm	30u"Ni Min.
3	GroundBar	1	SUS301-H, T=0.15mm	No Plating
2	Contact	16	C7025-TM04, T=0.15mm	1u" Au/Ni-Plated
1	Housing	1	PA9T	UL94 V-0, Black

CUSTOMER		GENERAL TOLERANCES UNLESS SPECIFIED		APPROVED BY: 程玉红		深圳市钜硕电子有限公司 钜硕电子 SHENZHEN JUSHUO ELECTRONICS CO., LTD	
		SIZE	UNITS	X±0.50	X°±5.0°		
SCALE	REV.	.XX±0.25	.XX°±2.5°	DESIGN BY: 程玉红	DWG NO.: JS-201804202378	SHEET 1/2	
A4	A	.X±0.35	.X°±3.0°				
1:1	A	.XXX±0.15	.XX°±2.0°				

RoHs

VER	MARK	PR. BY	ECR/ECN	DESCRIPTION	DATE
A		程玉红		NEW RELEASE	10/24' 20

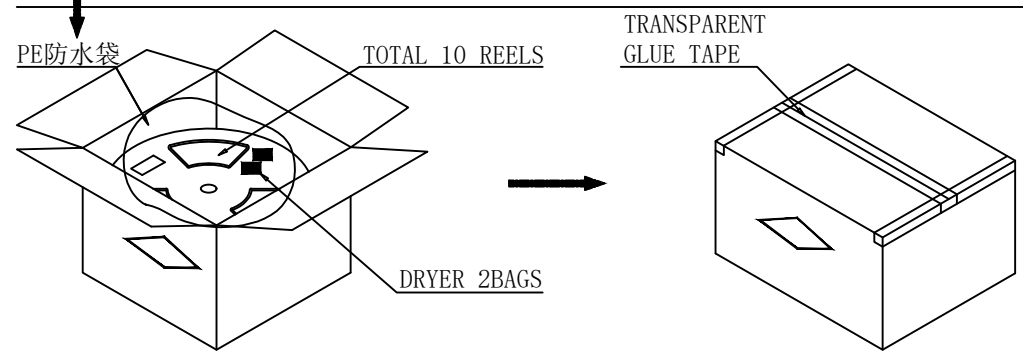
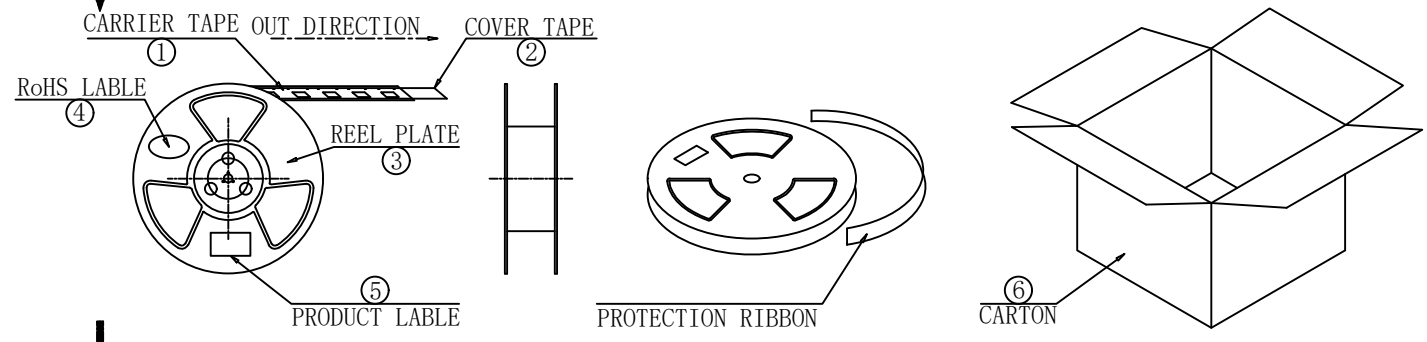
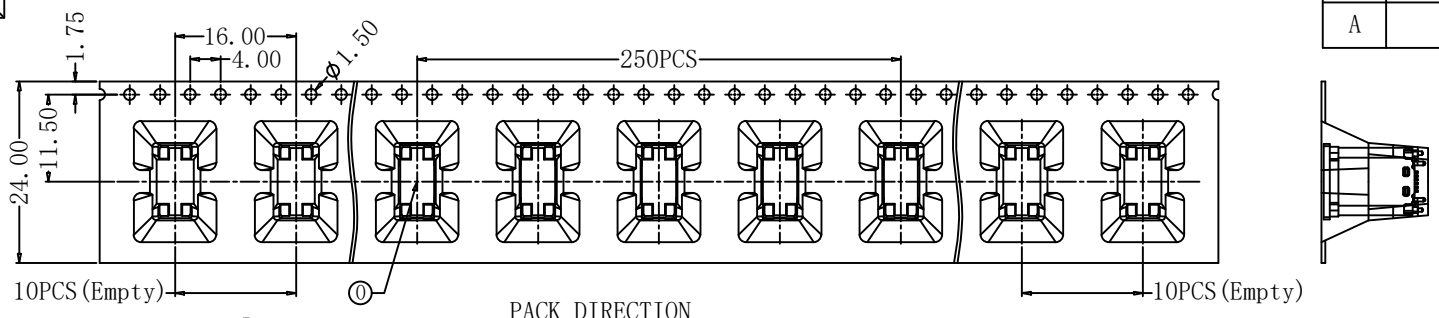

说明:

- 每卷前后各空10PCS, 尾部用美纹胶纸封住;
- 将产品放满盘后, 再卷一圈保护带, 用美纹胶纸将其封住, 并贴上1Pcs物料标签;
- 每10卷盘一叠共2500Pcs并装入1个外箱内;
- 在搬运过程中要轻拿轻放;
- 在运输中不可堆放过多(1.8M最高), 不可重压;
- 跌落测试条件:
成品箱从1.2米高度自由落体(一角三棱六面):
a. 产品不可跑出下带凹槽;
b. 产品不可有摔伤, 变形;
c. 内包装材料不可严重破损.

NO.	NAME	SPEC	Q' TY
①	TYPE C RECEPTACLE		2500PCS/CARTON
②	CARRIER TAPE	W=24mm, T=0.50mm	250PCS/PLATE
③	COVER TAPE	W=21.3mm	10PLATES/CARTON
④	REEL PLATE	330*100*24.4mm	10PCS/CARTON
⑤	RoHS LABEL		10PCS/CARTON
⑥	PRODUCT LABELER		10PCS/CARTON
⑦	CARTON	350*340*310mm	1PCS/PACKAGE

PACKAGING		GENERAL TOLERANCES UNLESS SPECIFIED		APPROVED BY: 幸坤新		深圳市钜硕电子有限公司 钜硕电子 SHENZHEN JUSHUO ELECTRONICS CO., LTD	
SIZE	UNITS	X±1.0	X*±5.0	CHECKED BY: 张德成	PART NO.:		TITLE: TYPE-C 16Pin母座
A4	MM[INCH]	.XX±0.50	.X*±3.5	DESIGN BY: 程玉红	JS16L-TYPE-C424-H105		双排立贴 长度10.5mm
SCALE	REV.	.XX±0.30	.XX*±2.5		DWG NO.:		SHEET
1:1	A	.XXX±0.15	.XXX*±1.5		JS-201804202378		2/2

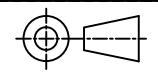

产 品 规 格 书

PRODUCT SPECIFICATION

TABLE I: PERFORMANCE REQUIREMENTS

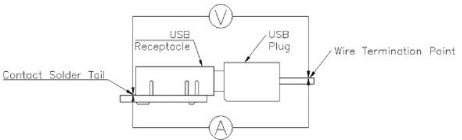
Items		Requirements	Test Methods
1	Confirmation of Product 产品确认	Product shall be conforming to the requirements of applicable product drawing 产品必须满足相关文件的规定。	Visually dimensions and functionally inspected per applicable product drawing. 目视尺寸及功能依照客户图面检查。
Electrical Requirement			
Items		Requirements	Test Methods
2	Low level Contact resistance 低电平接触阻抗	1. 40 mΩ (Max) initial for VBUS, GND and all other contacts. 2. Maximum change (delta) of +10 mΩ after environmental stresses. 1. 电源 PIN、接地 PIN 及其它 PIN 脚接触阻抗均为 40mΩ 最大。 2. 产品阻抗变化值不超过 10mΩ。	The low level contact resistance measurement is made from the solder tail of the receptacle to the soldering point of the plug. when measured at 20mV Max. open circuit at 100mA. Mated test contacts must be in a connector housing. Test reference standard: EIA-364-23B 接触阻抗测量方式从母头的焊脚处至公头的焊脚处。 在开路最大电流为 100mA 电压为 20mV 情况下测试胶芯插入时端子之间接触处的阻抗值。 测试参考标准: EIA 364-23B
			
3	Insulation Resistance 绝缘阻抗	100 MΩ Min. 100 MΩ 最小	Test between adjacent circuits Insulation Resistance of unmated and mated connectors. Test reference standard: EIA 364-21. 测试对插的连接器两个相邻端子之间的绝缘阻抗值。 测试参考标准: EIA 364-21
4	Dielectric Strength 耐电压	No breakdown shall occur. 产品不能出现衰竭、损坏现象。	when 100 Volts AC (RMS) is applied between adjacent contacts of unmated and mated connectors. Test reference standard: EIA-364-20. 使用 100V 交流电压测试公母头插入与拔出时相邻端子之间的承受电压情况。 测试参考标准: EIA 364-20

5	Contact current rating 温升	<p>1.A current of 3.0 A shall be applied collectively to VBUS pins (pins A4, A9, B4, and B9)</p> <p>2.1.25 A applied to the VCONN pin (B5 of the plug connector) with the return path through the corresponding GND pins (pins A1, A12, B1, and B12).</p> <p>3. A minimum current of 0.25 A shall also be applied individually to all the other contacts.</p> <p>1.VBUS pins 需通过电流3.0A(pin A4, A9, B4, and B9)。</p> <p>2.VCONN pin(公头B5 pin)及GND pins需通过电流1.25A(pins A1, A12, B1, and B12)。</p> <p>3.其余pins需通过最小电流0.25A。</p>	<p>When the currents are applied to the contacts, the temperature rise shall not exceed 30 °C at any point on the USB Type-C mated plug and receptacle under test, when measured at an ambient temperature of 25 °C.</p> <p>Test reference standard: EIA -364-70 method B</p> <p>在相对温度为25℃，当电流通过USB C type公母头连接器时，测试连接器中端子任一点温度不超过+30℃。</p> <p>测试参考标准：EIA 364-70 方法B</p>
---	------------------------------	---	--

Mechanical Requirement

	Items	Requirements	Test Methods
6	Insertion Force 插入力	<p>The initial connector insertion force shall be within the range from 0.5~2.0kgf.</p> <p>连接器初始插入力需在 0.5~2.0kgf 范围内。</p>	<p>Measure the force required to mate connector, At a maximum rate of 12.5mm(0.492") per minute.</p> <p>Test reference standard: EIA-364-13</p> <p>测试的力必须是相匹配的连接器，插入速度不超过每分钟 12.5mm。</p> <p>测试参考标准：EIA 364-13</p>
7	Extraction Force 拔出力	<p>The initial connector Extraction force shall be within the range from 0.8~2.0kgf.</p> <p>连接器初始拔出力需在 0.8~2.0kgf 范围内。</p>	<p>Measure the force required to mate connector, At a maximum rate of 12.5mm(0.492") per minute.</p> <p>Test reference standard: EIA-364-13</p> <p>测试的力必须是相匹配的连接器，拔出速度不超过每分钟 12.5mm。</p> <p>测试参考标准：EIA 364-13</p>
8	Durability or Insertion/extraction Cycles 耐久或插入拔出次数	<p>The durability rating shall be 10,000 cycles.</p> <p>耐久测试 10000 次。</p>	<p>The durability test shall be done at a maximum rate of 200 cycles per Hour and no physical damage to any part of the connector and cable assembly shall occur.</p> <p>Test reference standard:EIA-364-09</p> <p>耐久测试速度不超过每小时 200 个循环，且测试后的产品及线材本身任何部位不能出现损坏。</p> <p>测试参考标准：EIA 364-09</p>

9	Physical Shock 物理冲击	No breakdown shall occur. 产品不能出现损坏现象。	No discontinuities of 1 μ s or Longer duration. when mated USB C type connectors are subjected to 11ms duration 30Gs half-sine shock pluses. Three shocks in each direction applied along three mutually perpendicular planes for a total of 18 shocks. Test reference standard: EIA 364-27 Test Condition H. 匹配USB C TYPE 连接器, 中断不得大于或等于1 μ s, 30Gs的半波脉冲承受11ms, 从三个正交的方向施加冲击, 总冲击次数为18次。
---	-------------------------------	--	--

Environmental Requirements

	Items	Requirements	Test Methods
10	Humidity 恒温恒湿	Shall meet visual requirements, show no physical damage. Contact Resistance (Low Level) 40 m Ω max. Dielectric Strength should be OK, Insulation Resistance should be 100 M Ω min. 产品外观良好, 无损坏。接触阻抗: 40 m Ω 最大; 耐电压测试OK, 绝缘阻抗100M Ω 最小。	Temperature: 25~65 $^{\circ}$ C, Relative humidity: 90-95%, Duration: 96Hours, Circulate test: 10 Cycles. Test reference standard: EIA 364-31 温度: 25~65 $^{\circ}$ C, 相对湿度: 90-95%, 持续时间: 96 小时, 循环测试: 10次 测试参考标准: EIA 364-31。
11	Thermal shock 冷热冲击	Shall meet visual requirements, show no physical damage. Contact Resistance (Low Level) 40 m Ω max. Dielectric Strength should be OK, Insulation Resistance should be 100 M Ω min. 产品外观良好, 无损坏。接触阻抗: 40 m Ω 最大; 耐电压测试OK, 绝缘阻抗100M Ω 最小。	Temperature range from -55 $^{\circ}$ C to +85 $^{\circ}$ C .Start from -55 $^{\circ}$ C. After 30 min. change to +85 $^{\circ}$ C, change time is no more than 30 seconds. Total 5 cycles. Test reference standard: EIA 364-32 温度变化范围: -55 $^{\circ}$ C ~ +85 $^{\circ}$ C, 从-55 $^{\circ}$ C开始, 30分钟后换到+85 $^{\circ}$ C; 转换时间不超过30秒; 共5 个循环。 测试参考标准: EIA 364-32

12	<p>Hot air reflow or IR reflow for SMT curing process SMT 热风回流焊</p>	<p>More than 95% of the dipped surface shall be wet with solder 超过95%的焊接面积浸到锡。</p>	<p>Place subjected connector on the PCB Board and expose them to the reflow oven and apply the following condition: Room 1: preheat temperature 150°C -170°C for 100 seconds. Room 2: preheat temperature 170°C - 200°C for 100 seconds. Room 3: reflow temperature 200°C -260°C for 120-60 seconds.(For 260°C ONLY 5-10 seconds) 将产品放在PCB板上,然后放入回焊炉中并用于以下条件: 时间段1: 预热温度150°C-170°C 100秒。 时间段2: 预热温度170°C - 200°C 100秒。 时间段3: 回焊炉温度200°C - 260°C 100秒。(260°C 时间仅5~10S)</p>
13	<p>Solderability 可焊性</p>	<p>The inspected area of each lead must have 95% solder coverage Minimum. 检测焊接端的锡覆盖率需大于95%</p>	<p>Solder pot temperature: 250±5°C Soldering time: 3 to 5 Seconds Test reference standard: EIA 364-52 锡炉温度: 250±5°C, 焊接时间: 3~5 秒 测试参考标准: EIA 364-52。</p>
14	<p>Salt Spray 盐雾测试</p>	<p>Shall meet visual requirements, No detrimental corrosion allowed in contact area and base metal exposed. 产品外观良好, 端子及外壳金属无生锈、腐蚀及露底材不良。</p>	<p>Subject mated connectors to 35+/-2 °C and 5+/-1% salt condition for 48 hours. After test, rinse the sample with water and recondition the room temperature for 1 hour. Test reference standard: EIA-364-26B. 测试的连接器需放于温度35±2°C, 盐水浓度(重量比)5±1%的容器中测试48小时。测试后的产品使用清水冲洗后放入常温下1小时。 测试参考标准: EIA 364-26。</p>

TABLE II:

REFLOW SOLDERING PROFILE

Pb-free reflow profile requirements:

Parameter	Reference	Specification
Average temperature gradient in preheating		2.5°C/s
Soak time	T soak	2-3 minutes
Time above 217°C	t1	60 s
Time above 230°C	t2	50 s
Time above 250°C	t3	5 s
Peak temperature in reflow	T peak	260°C (+/-5°C)
Temperature gradient in cooling		Max -5°C/s

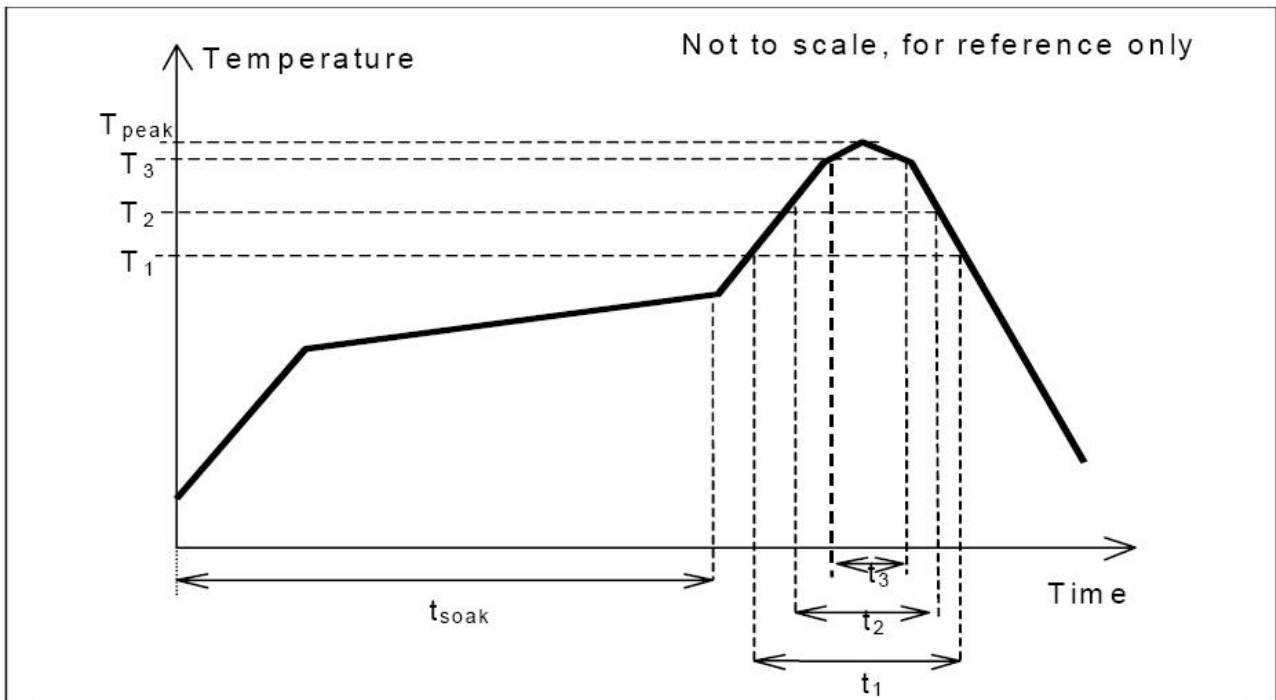

This profile is the minimum requirement for evaluating soldering heat resistance of components. Heat transfer method used for reflow soldering is hot air convection. The actual air temperatures used to achieve the specified profile is higher and largely dependent on the reflow equipment.

产品功能测试报告 Product Function Test Report

委托单位 Client	品质部	委托日期 Commission	2023.02.28	测试单位 Tester	实验室	测试日期 Test Date:	2023.02.28	报告编号 Serial	YFSYS20230303001
产品品名 Part name	TYPEC-6pin防水母座板上型带塑胶柱 + (TID公头)		样品数量 Sample Qty'	1PCS		<input type="checkbox"/> 样品描述 sample describing	<input type="checkbox"/> 新产品验证 New product validation	<input checked="" type="checkbox"/> 日常验证 Daily verification	
测试项目 Test Item	<input type="checkbox"/> 接触阻抗 LLCR	<input type="checkbox"/> 耐电压 DWW	<input type="checkbox"/> 冷热冲击 Thermal Shock		<input type="checkbox"/> 盐水喷雾 Salt Spray	<input checked="" type="checkbox"/> 耐久性测试 Durability		<input checked="" type="checkbox"/> 插拔力 Mating force&Unmating force	
	<input type="checkbox"/> 沾锡测试 Solder ability	<input type="checkbox"/> 高温测试 Temperature life	<input type="checkbox"/> 保持力 Retention Force		<input type="checkbox"/> 恒温恒湿 Humidity	<input type="checkbox"/> 绝缘电阻 InsulationResistance		<input type="checkbox"/> 其它测试 Other test	

测试过程及测试方法 The test process and test methods:

测试仪器 Test Instrument	型号/规格 Type/specification	全自动插拔试验机			计量有效期 Measure the term of validity	2023/10/28
测试环境 TestEnvironment	温度 Temperature	23℃	湿度 Humidity	58%	测试依据 Test Standard	工程图面
测试项目及方法 The test items and methods		插拔力测		以12.5mm/min 速度插拔32次		
		耐久测试		以500次/H 速度测试10000次, 2500次翻转一面吹屑后继续测试		

测试结果 Test Result 列出测试/实验过程中所获得的数据资料或观察到的现象, 数据资料以平均值表示 List the data materials or phenomenon that observe tested / obtained in the experiment course, the data materials are expressed with average

测试项目 Test Item	测定值/现象 Test Value/Phenomenon (单位unit: kg)											
	1	2	3	4	5		最大值 Maximum	最小值 Minimum	平均值 Avg	规格 Specificati	判定 Judge	
插拔力测试	插入力	10.25	9.41	8.97	9.24	9.66	10.25	8.97	9.54	5-20 N	OK	
	拔出力	14.57	14.85	14.91	14.96	15.17	15.17	14.57	14.89	5-20 N	OK	
耐久测试		1000	3000	5000	7000	9000	10000	最大值 Maximum	最小值 Minimum	平均值 Avg	规格 Specificati	判定 Judge
	插入力	13.92	13.27	11.34	10.21	9.17	13.92	9.17	11.57	5-20 N	OK	
	拔出力	16.27	17.30	12.81	9.86	8.71	17.30	8.71	12.99	5-20 N	OK	
10000耐久后插拔		1	2	3	4	5	最大值 Maximum	最小值 Minimum	平均值 Avg	规格 Specificati	判定 Judge	
	插入力	6.68	6.90	6.97	7.23	7.24	7.24	6.68	6.99	5-20 N	OK	
	拔出力	8.67	8.93	9.23	9.37	9.54	9.54	8.67	9.14	6-20 N	OK	

10000耐久后电性测试OK

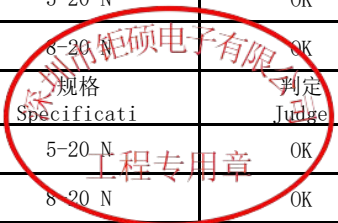

产品功能测试报告 Product Function Test Report

测试项目 Test Item	<input type="checkbox"/> 接触阻抗 LLCR	<input type="checkbox"/> 耐电压 DWV	<input type="checkbox"/> 冷热冲击 Thermal Shock	<input type="checkbox"/> 盐水喷雾 Salt Spray	<input checked="" type="checkbox"/> 耐久性测试 Durability	<input checked="" type="checkbox"/> 插拔力 Mating force&Unmating force
	<input type="checkbox"/> 沾锡测试 Solder ability	<input type="checkbox"/> 高温测试 Temperature life	<input type="checkbox"/> 保持力 Retention Force	<input type="checkbox"/> 恒温恒湿 Humidity	<input type="checkbox"/> 绝缘电阻 InsulationResistance	<input type="checkbox"/> 其它测试 Other test

初始插拔曲线图

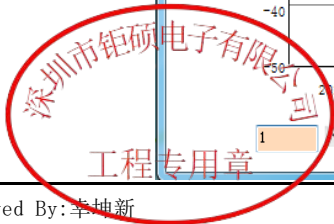
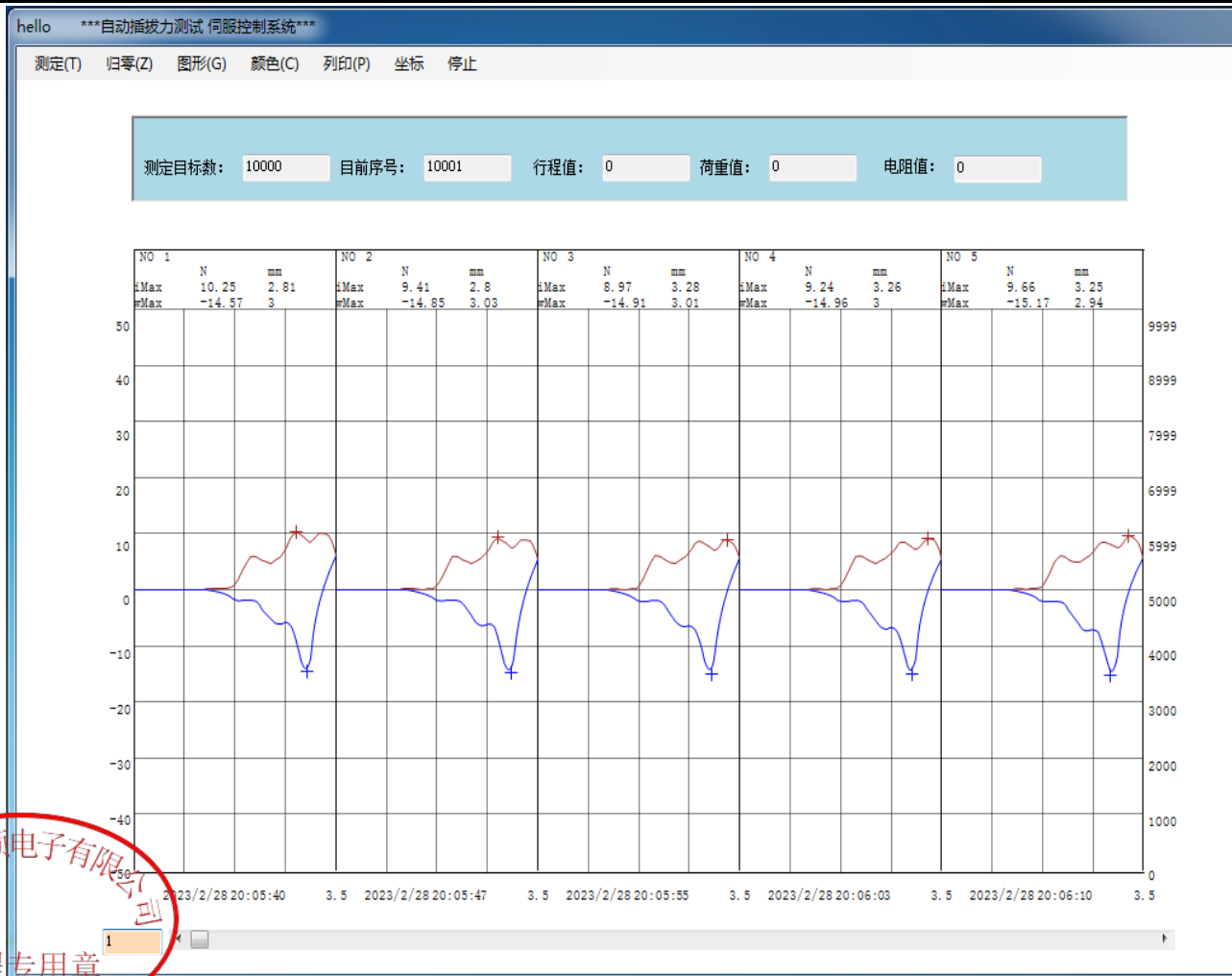

Approved By: 李坤新

Checked By: /

Test By: 王琨

产品功能测试报告 Product Function Test Report

测试项目 Test Item	<input type="checkbox"/> 接触阻抗 LLCR	<input type="checkbox"/> 耐电压 DWV	<input type="checkbox"/> 冷热冲击 Thermal Shock	<input type="checkbox"/> 盐水喷雾 Salt Spray	<input checked="" type="checkbox"/> 耐久性测试 Durability	<input checked="" type="checkbox"/> 插拔力 Mating force&Unmating force
	<input type="checkbox"/> 沾锡测试 Solder ability	<input type="checkbox"/> 高温测试 Temperature life	<input type="checkbox"/> 保持力 Retention Force	<input type="checkbox"/> 恒温恒湿 Humidity	<input type="checkbox"/> 绝缘电阻 InsulationResistance	<input type="checkbox"/> 其它测试 Other test

耐久插拔曲线图

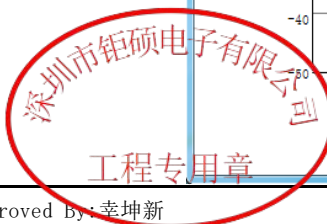
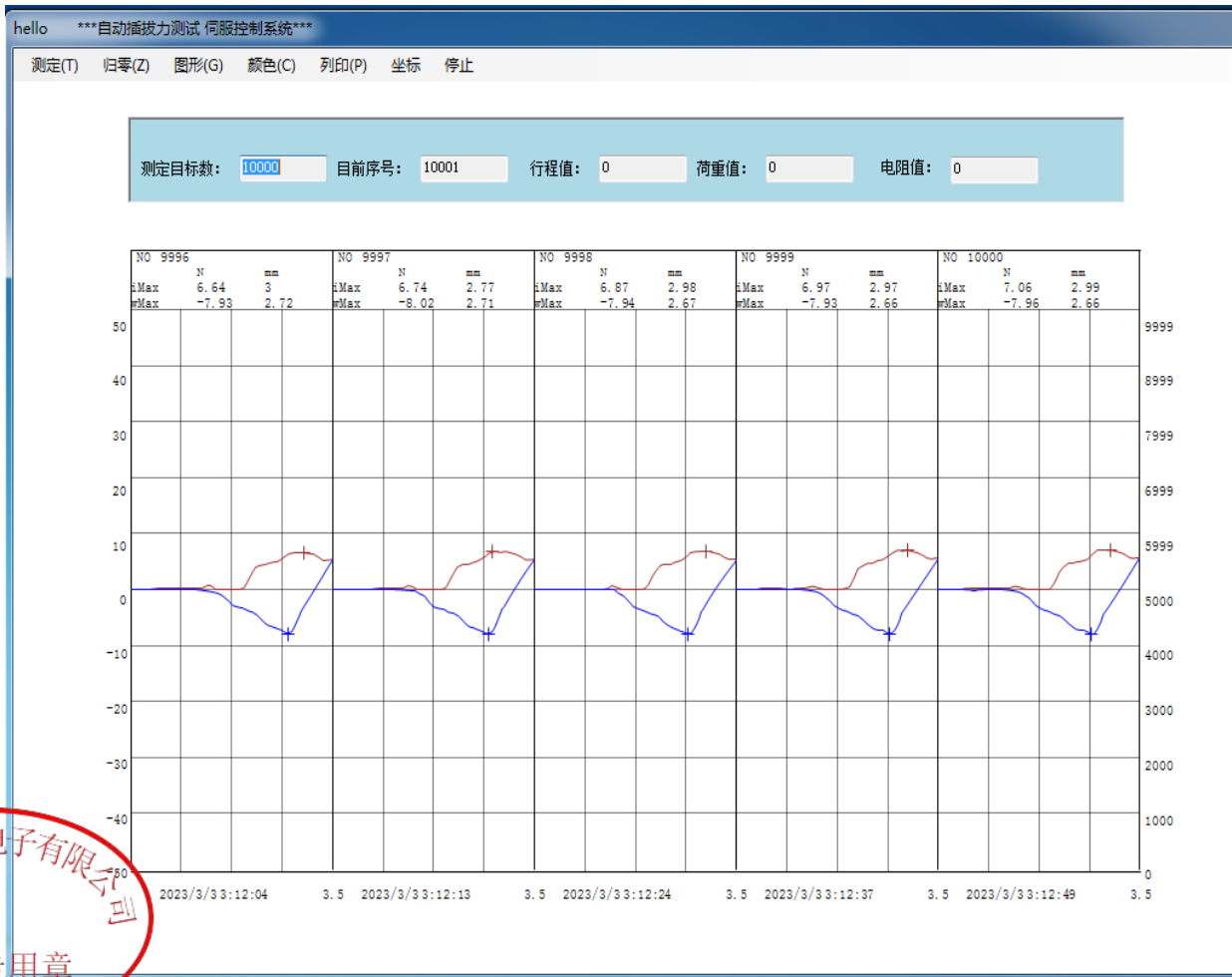

Approved By: 幸坤新

Checked By: /

Test By: 王琨

产品功能测试报告 Product Function Test Report

测试项目 Test Item	<input type="checkbox"/> 接触阻抗 LLCR	<input type="checkbox"/> 耐电压 DWV	<input type="checkbox"/> 冷热冲击 Thermal Shock	<input type="checkbox"/> 盐雾喷雾 Salt Spray	<input checked="" type="checkbox"/> 耐久性测试 Durability	<input checked="" type="checkbox"/> 插拔力 Mating force&Unmating force
	<input type="checkbox"/> 沾锡测试 Solder ability	<input type="checkbox"/> 高温测试 Temperature life	<input type="checkbox"/> 保持力 Retention Force	<input type="checkbox"/> 恒温恒湿 Humidity	<input type="checkbox"/> 绝缘电阻 InsulationResistance	<input type="checkbox"/> 其它测试 Other test

10000次耐久后插拔曲线图

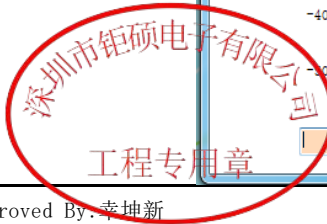

Approved By: 幸坤新

Checked By: /

Test By: 王琨

QC工程图

产品描述: TYPE-C系列	产品料号: 适用于所有TYPE-C系列	版本: A	编号及版本: JS-SIP-0122-01	制定日期: 2018/03/18
----------------	---------------------	-------	-----------------------	------------------

作业流程	作业过程描述	控制要点/参数/条件	检验频率	作业者/检验者	管制界限值	检测方法	级判定	处理方式
	开始							
	进料检验	原材料、零部件料号、规格	MIL-STD-105E	IQC	依工程图/SOP/SIP	目视/送实验室检测	2&3	允收/退货/挑选/特采
	投入物料	原材料、零部件料号、规格	每批物料	线长/IPQC	生产任务单/BOM	目视/送实验室检测	1	退货
	冲压/成型生产	尺寸/外观/功能/装配等	抽检/自检 2模/1H	作业员/IPQC	依工程图/SOP/SIP	目视/测试/测量/装配	1	标示隔离/重工/报废
	外观	外观/尺寸/功能	全检 两模/1H	作业员/IPQC	依工程图/SOP/SIP	目视/测量	1	标示隔离/重工
	包装入库	标示日期/班次/小心运输	袋 /每批	作业员/IPQC	入库单	目视	1	调整
	投入物料	零部件料号/规格	每批物料	线长/IPQC	生产任务单/BOM	目视/送实验室检测	1	退货/挑选/特采
	裁切端子	端子无变形/氧化等	自检	作业员	作业指导书	目视	0	调整
	自动机插端/手工插端	端子无变形/铆合尺寸/折料带端子无变形	2模/1H	作业员/IPQC	依工程图/SOP/SIP	目视/测量	1	调机
	装配塑胶	装配到位/无缺料/毛边/堵孔/断裂/混料/错位/保持力	2模/1H	作业员/IPQC	依工程图/SOP/SIP	目视/送实验室检测	1	标示隔离/重工/报废
	装配焊片	装配到位/毛边/堵孔/断裂/混料/脱落	2模/1H	作业员/IPQC	依工程图/SOP/SIP	目视/送实验室检测	1	标示隔离/重工/报废

核准: 幸坤新

审核: 刘朋飞

制订: 陈艳

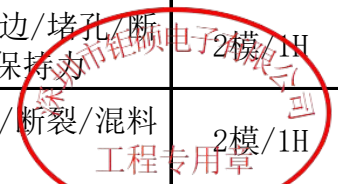

QC工程图

产品描述: TYPE-C系列	产品料号: 适用于所有TYPE-C系列	版本: A	编号及版本: JS-SIP-0122-02	制定日期: 2018/03/18
----------------	---------------------	-------	-----------------------	------------------

作业流程	作业过程描述	控制要点/参数/条件	检验频率	作业者/检验者	管制界限值	检测方法	判定级别	处理方式
	初检	无缺料/毛边/堵孔/色差/高低针/混料/斜针/缺针/电镀不良等	全检	FQC	作业指导书	目视/测量	0	标示隔离/重工
	入管	无混料/少数/多装等	自检	作业员	作业指导书	目视	0	重工
	总检	无缺料/毛边/堵孔/色差/高低针/混料/斜针/缺针/电镀不良等	全检	FQC	作业指导书	目视/测量	0	标示隔离/重工
	OQC抽检	无缺料/毛边/堵孔/色差/高低针/混料/斜针/缺针/电镀不良等	抽检	OQC	SIP/SOP/MIL-STD-105E II	目视/测量	0	标示隔离/重工
	包装入库	分清每批日期/搬运/轻放	每批	作业员	入库单	目视	0	调整
	出货检验	合格标签内容/出货内容	每批	OQC	作业指导书	目视	1	标示隔离/重工
	完 成							



备注: 1. 每次开始生产调机及换料后必须进行首件检验, 数量为两模。工程图面标示“▼”的尺寸全量测; 耐高温测试、焊锡性测试、功能测试等。
 2. 插入力、拔出力及保持力请参见工程图及规格书

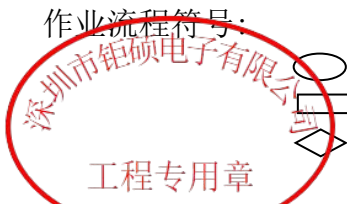

判定级别:

- 0. 作业员自检
- 1. 线长/IPQC/IPQC线长
- 2. 工程师/课长/经理
- 3. 副总/总经理

作业流程符号:



-  开始/终止
-  作业
-  检验/测试

-  物料投入
-  存储

核准: 幸坤新

审核: 刘朋飞

制订: 陈艳