

# 深圳市晶科鑫实业有限公司



## 样品承认书

客户代码:	
物料名称:	贴片钟振
规格型号:	SMD2016 27.000MHz 3.3V ±30PPM总频差 -40~85℃
P N/ SJK:	1N27000G33YC
环保属性:	<input checked="" type="checkbox"/> RoHS <input checked="" type="checkbox"/> REACH <input checked="" type="checkbox"/> HF <input type="checkbox"/> PAHS <input type="checkbox"/> 其它
版 次:	A1 2025-7-29 初版 最小包装: 3000pcs/real
湿敏等级:	一级

承 认 签 章					
供 应 商 承 认			( ) 公 司 承 认		
制 定	审 核	核 准	工 程 师	审 核	批 准
贺丹斌	李相同	刘惠光			
SJK 支持			盖章签署		
FAE_EMAIL			日 期		
日 期			批示: <input type="checkbox"/> 接受 <input type="checkbox"/> 有条件接受		
备注:					

# Crystal oscillator

## SMD CMOS Output 2.0×1.6×0.75mm 1N Series



### FEATURE

- Ultra Small SMD seam sealed clock crystal oscillator units.
- For applications in WLAN, Bluetooth, DSC, DSL and other IT product.
- Tri-state function available.
- RoHS Compliant / Pb Free.

### ELECTRICAL SPECIFICATIONS

Parameters	Condition\Model	1N
Fan Out Type		CMOS
Supply Voltage		3.3V±10%
Frequency		27.000MHz
Operating Temperature		-40°C to +85°C
Current		5mA max
Frequency Stability	AT 25°C	±10ppm
	Over Operating Temperature range	±20ppm
Output Voltage	Vol(max)	10%VDD
	VoH(min)	90%VDD
Rise/Fall Time	AT 0.1VDD~0.9VDD	5ns max
Load Capacitance		15pF
Duty Cycle		50±10%
Storage Temperature		-55~+125°C
Start-upTime		5ms max
Aging		±3ppm (first year at 25°C)
Tri-State	Output Active	0.7VDD Min Pin 1 Tri-state
	Output in High-Impedance state	0.3VDD Max
PAD Connection	PIN#1 Tri-State/NC	PIN#3 OUT
	PIN#2 GND	PIN#4 Vdd

# Crystal oscillator SMD CMOS Output 2.0×1.6×0.75mm 1N Series



## DIMENSION (Unit: mm)

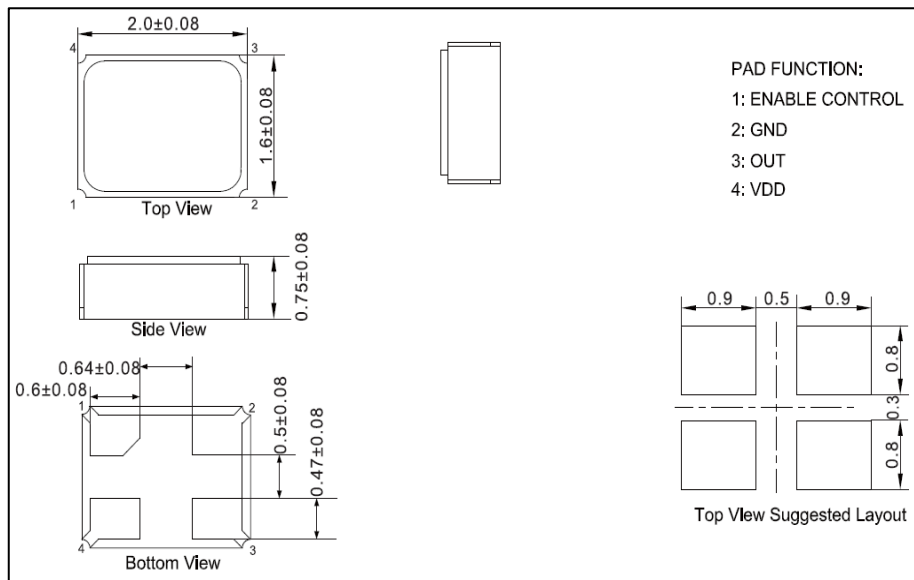

## MARK



## MEASUREMENT CIRCUIT

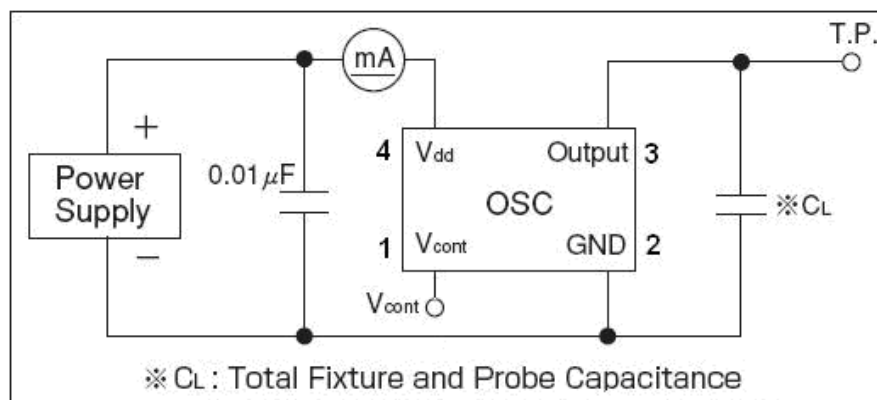

## WAVEFORM CONDITIONS

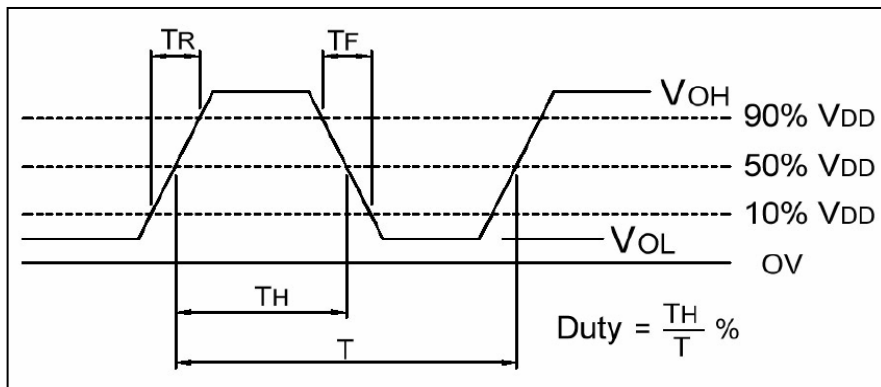

## REFLOW CONDITION

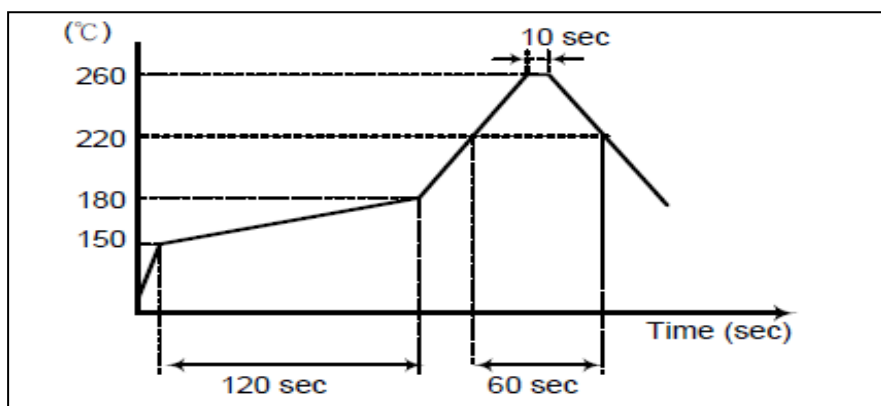

The reflow temperature profile may vary depending on the product model, specifications and frequency range. Refer to the individual product specifications for details

## Note

1. General cleaning solutions or ultrasonic cleaning method may be used to clean our products. However, under certain circumstances, ultrasonic cleaning machine could generate resonance at the oscillation frequency of our products and thus deteriorate the electrical characteristics in devices, and even damage the overall structure of devices. Therefore, verification test is recommended before cleaning.
2. Avoid mounting and processing by Ultrasonic welding this method has a possibility of an excessive vibration spreading inside the crystal products and becoming the cause of characteristic deterioration and not oscillating.

## CARRIER TYPE

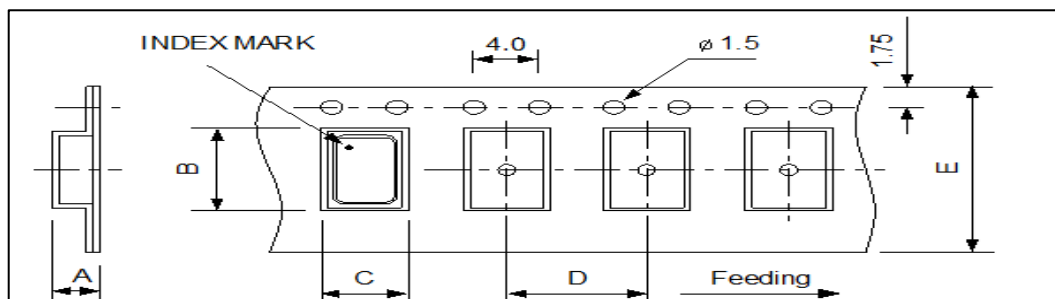

## REEL

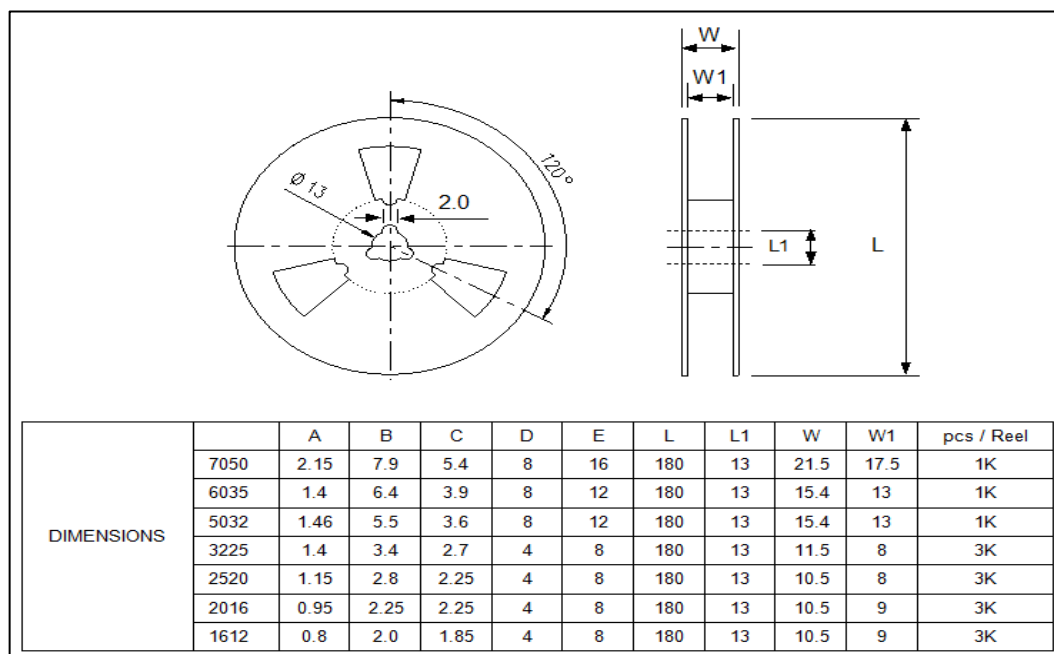

## RELIABILITY TEST SPECIFICATIONS

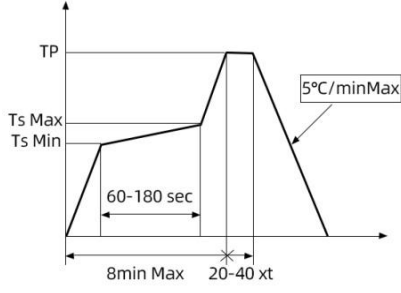
Test item	Equipment	Condition	Specification
1.SOLDERABILITY TEST	SJK-REL001、RC-328A	<p>TP:260°C TsMax: 200°C TsMin: 150°C 2 time</p> 	MIL-STD-883E Method 2003.7
2. HERMETICITY TEST	HELIOT-306S	Pressurized 0.4~0.5Mpa ethanol sealed tank for 10 minutes	MIL-STD-883E Method 1014.10
3. VIBRATION TEST	HG-V4、S&A 250B	Enable Crystal(10g) from 10-55-10Hz,X、Y、Z horizontal,1 Minute vibration/time, 1time/ 2 hours.	MIL-STD-883E Method 2007.3
4. MECHANICAL SHOCK	HPC-200、S&A 250B	Enable Crystal 50G(490m/s <sup>2</sup> ) time=11 ms speed=3.4 m/s half sine wave oscillation	JIS C6701
5. DROP TEST	HARD BOARD.S&A250B	75cm High,3 times on hard board	MIL-STD-202F Method 213B
6. HIGH&LOW TEMP STORAGE TEST(Static test)	H-PTH-80CK & HM101-3ABN, S&A 350B/250B	High temperature: 125°C±2 °C,1000hr; Low temperature:-40°C±3 °C,1000hrs	MIL-STD883C, METHOD 1011.8
7. TEMP &HUM CYCLING TEST	H-PTH-80CK CHAMBE, S&A 350B/250B	Temperature:-10°C±2°C~65°C±2 °C, Humidity:93±3%,1 cycle need 24 hrs. 5cycles.	MIL-STD-883E Method 1005.8
8. HIGH TEM. & HUM.STORAGE TEST	H-PTH-80CK CHAMBE, S&A350B/250B	Temperature:85°C±2, Humidity:85+3,-2%,Store 96 hrs	JIS C6701
9. AGING TEST	H-PTH-80CK CHAMBE, S&A350B/250	Temperature:85°C±2, Store 1000 hrs	JIS C5023