

修 订	标 记	修 改 描 述	签 名	日 期
REV	MARK	REVISION DESCRIPTION	SIGNATURE	DATE
AO		NEW DWG		2016-03-12

规格说明: Specifications:

电气特性: Electrical:

1. 额定电流: Current Rating  
1.5A/contact terminal
2. 额定电压: Voltage Rating  
30V DC
3. 接触阻抗: Contact Resistance  
30 milliohms MAX
4. 耐电压: Dielectric Withstanding Voltage:  
500 V AC AT Sea Level
5. 绝缘阻抗: Insulation Resistance:  
1000MEGA ohms MIN

物理性能: Mechanical:

1. 插拔力: Connector Mate and Unmate Force  
Mate force: 3.57kgf (MAX)  
Unmate force: 1.02kgf (MIN)
2. 端子保持力: Terminal Retention  
1.2kgf (MIN)

原材料: Material:



1. 塑胶: Housing:  
Hing Temperature Thermoplastics,  
U1 94V-0 LCP White/Black
2. 端子: Contact: Copper Alloy C5191
3. 外壳: Shell: Copper Alloy SUS304

电镀: Finish:

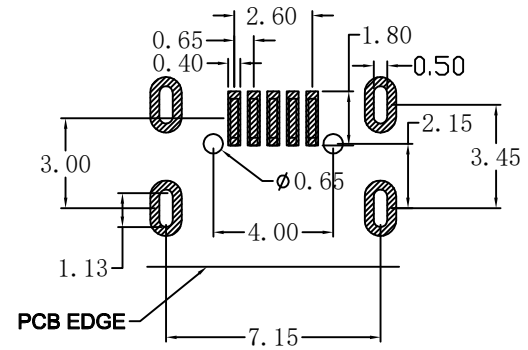
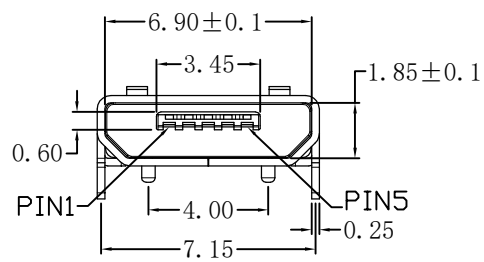
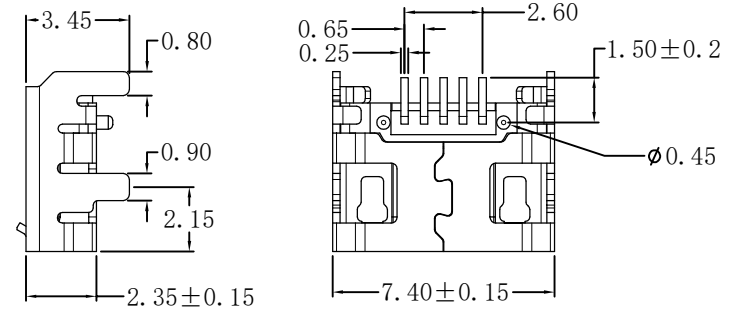
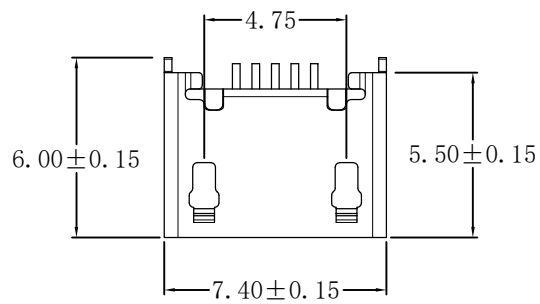
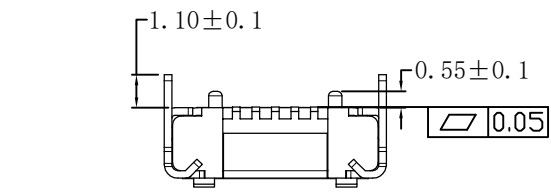
1. 端子: Contact: Plated Gold in Mating Area;  
半金锡 1U
2. 外壳: Shell:  
Nickel Plating



RECOMMENDED PCB LAYOUT  
TOLERANCE: ±0.05

		<b>深圳市华德共创科技有限公司</b> Shenzhen Huade co-create Technology Co., LTD 电话: 0755-27111216 传真: 0755-29940187						
-TOLERANCES- UNLESS OTHERWISE SPECIFIED 公差参数表		 		TITLE: MICRO四脚短脚平口铜壳镀镍有柱 产品名称: 针长1.5				
X.X	±0.30	X.X*	±3°	APPD: 核准:	PART NO: 产品编号: MICRO-ZL-102PWB			
X.XX	±0.20	X.XX*	±2°	CHECK: 校对: 王建业	DATE	SCALE	UNIT	CODE NUMBER
X.XXX	±0.10	X.XXX*	±1°	DRAW: 绘图: 黄艳兰	2016-03-12	1:1	mm	A001

由 Autodesk 教育版产品制作

由 Autodesk 教育版产品制作