

1924955-1 ✓ ACTIVE

Generation Y Connector System

TE Internal #: 1924955-1

Automotive Terminals, Receptacle, Mating Tab Width .8 mm [.031 in], Tab Thickness .64 mm [.025 in], Generation Y Connector System

[View on TE.com >](#)



Terminals & Splices > Automotive Terminals

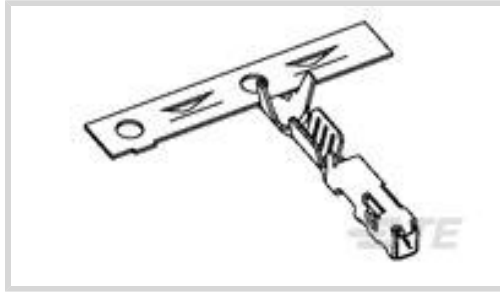

Terminal Type: **Receptacle**

Mating Tab Width: **.8 mm [.031 in]**

Mating Tab Thickness: **.64 mm [.025 in]**

Terminal Transmits: **0 – 24 A (Low Power)**

Wire Size: **22 – 20 AWG**

Features

Product Type Features

Receptacle Style	180°
Sealable	No
Primary Locking Feature	Clean Body

Contact Features

Contact Size	.64mm
Contact Fabrication	Stamped & Formed
Wire Contact Termination Area Plating Material	Tin
Typical Current Rating	9 A
Crimp Type	F-Crimp
Terminal Type	Receptacle
Mating Tab Width	.8 mm [.031 in]
Mating Tab Thickness	.64 mm [.025 in]
Interface Plating	Tin (Sn)

Termination Features

Termination Method to Wire & Cable	Crimp
Product Terminates To	Wire

Dimensions

Compatible Insulation Diameter Range	1.5 – 1.85 mm [.059 – .073 in]
Wire Size	.35 – .5 mm ²



Wire Size Search	20 AWG, 21 AWG, 22 AWG
------------------	------------------------

Usage Conditions

Insulation Option	Uninsulated
Operating Temperature (Max)	80 °C, 85 °C, 90 °C, 100 °C[176 °F][185 °F] [194 °F][212 °F]
Operating Temperature Range	-40 – 100 °C[-40 – 212 °F]

Operation/Application

Compatible With Wire Base Material	Copper
------------------------------------	--------

Industry Standards

Compatible With Agency/Standards Products	SAE/USCAR-2 / USCAR-21
---	------------------------

Packaging Features

Packaging Quantity	7500
Packaging Method	Reel

Other

Terminal Transmits	0 – 24 A (Low Power)
--------------------	----------------------

Product Compliance

[For compliance documentation, visit the product page on TE.com>](#)

EU RoHS Directive 2011/65/EU	Compliant
EU ELV Directive 2000/53/EC	Compliant
China RoHS 2 Directive MIIT Order No 32, 2016	No Restricted Materials Above Threshold
EU REACH Regulation (EC) No. 1907/2006	Current ECHA Candidate List: JUNE 2023 (235) Candidate List Declared Against: JUNE 2023 (235) Does not contain REACH SVHC
Halogen Content	Low Halogen - Br, Cl, F, I < 900 ppm per homogenous material. Also BFR/CFR/PVC Free
Solder Process Capability	Not applicable for solder process capability

Product Compliance Disclaimer

This information is provided based on reasonable inquiry of our suppliers and represents our current actual knowledge based on the information they provided. This information is subject to change. The part numbers that TE has identified as EU RoHS compliant have a maximum concentration of 0.1% by weight in homogenous materials for lead, hexavalent chromium, mercury, PBB, PBDE, DBP, BBP, DEHP, DIBP, and 0.01% for cadmium, or qualify for an exemption to these limits as defined in the Annexes of Directive 2011/65/EU (RoHS2). Finished electrical and electronic equipment products will be CE marked as required by Directive 2011/65/EU. Components may not be CE marked. Additionally, the part

numbers that TE has identified as EU ELV compliant have a maximum concentration of 0.1% by weight in homogenous materials for lead, hexavalent chromium, and mercury, and 0.01% for cadmium, or qualify for an exemption to these limits as defined in the Annexes of Directive 2000/53/EC (ELV). Regarding the REACH Regulation, the information TE provides on SVHC in articles for this part number is based on the latest European Chemicals Agency (ECHA) 'Guidance on requirements for substances in articles' posted at this URL: <https://echa.europa.eu/guidance-documents/guidance-on-reach>

Compatible Parts



TE Part # CAT-T319-CH8172
TH/.025 CONNECTOR SYSTEM,
HOUSING

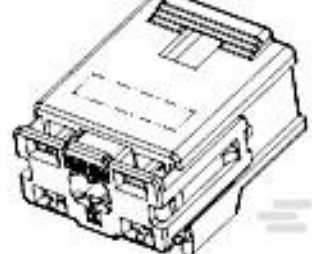

TE Part # 1456471-1
8p Hybrid 0.64/2.8 Unsealed PI



TE Part # 2288274-1
24P HYBRID 0.64/2.8 PLUG ASSY, A
KEY

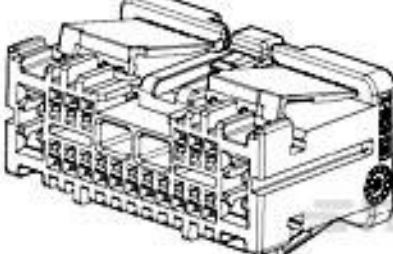

TE Part # 1924126-1
21p Hybrid - 1pc Unsealed Plug, Key A

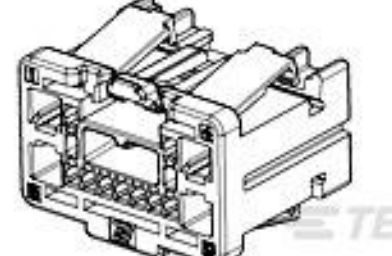

TE Part # 1924667-1
13p Hybrid - 1pc Unsealed Plug, Key A



TE Part # 2035363-1
1X6 GENERATION Y ASSY KEY B



TE Part # 1924341-1
18P, 1 Row Carrier for 54P LAC



TE Part # 1924340-1
36P, 2 Row Carrier for 54P LAC



TE Part # 2098634-1
Carrier, 20P, GY LAC, Black



TE Part # 2098216-1
32P Carrier, GY



TE Part # 2288276-1
Assy, Plug, USCAR, GenY, 20p, Key A, No
CPA

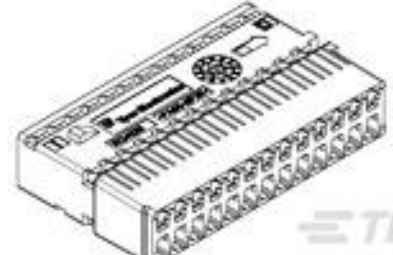

TE Part # 1924136-2
Carrier, 26P Generation Y, 52P Conn

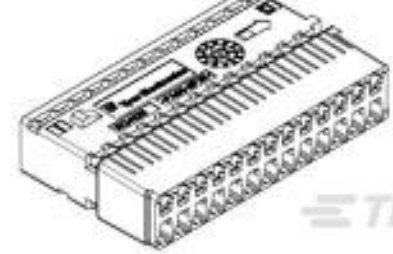

TE Part # 1924136-1
Carrier, 26P Generation Y, 52P Conn



TE Part # 1924136-3
Carrier, 26P GenerationY, Hand Mate
Conn



TE Part # 2035360-1
1X4 GENERATION Y ASSY KEY A



TE Part # 2063291-1
PRO-C HT & DIE GEN Y



TE Part # 1-2035077-1
PLUG HSG, 4 POSN HYBRID 0.64/2.8



TE Part # 1-2035077-2
PLUG HSG, 4 POSN HYBRID 0.64/2



TE Part # 1-2035077-3
PLUG HSG, 4 POSN HYBRID 0.64/2



TE Part # 1-2035077-4
PLUG HSG, 4 POSN HYBRID 0.64/2

Also in the Series | Generation Y Connector System



Automotive Connector Caps & Covers (16)



Automotive Housings(128)



Automotive Terminals(39)



Insertion & Extraction Tools(1)



PCB Headers & Receptacles(15)

Customers Also Bought



TE Part #201532-4
RECEPT BLOCK,104 POSN,M SERIES

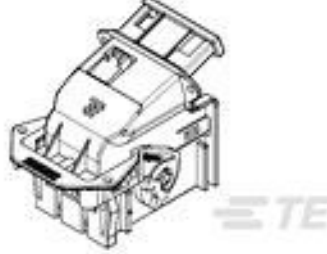

TE Part #1924346-1
Shield Assy, 52P Generation Y, LAC, AE



TE Part #1924678-1
26P SMT LAC HDR ASY, KEY AE, Hand Mate



TE Part #1924341-1
18P, 1 Row Carrier for54P LAC

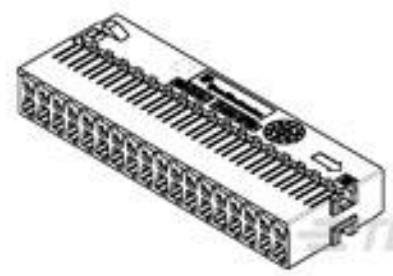

TE Part #1924340-1
36P, 2 Row Carrier for 54P LAC



TE Part #1924346-3
Shield Assy, 52P Generation Y, LAC, BF

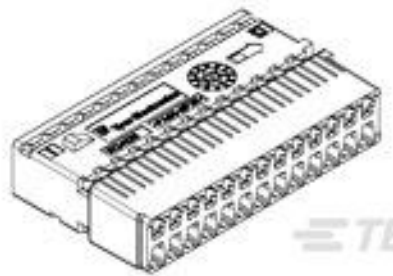

TE Part #1924136-2
Carrier, 26P Generation Y, 52P Conn



TE Part #1924136-1
Carrier, 26P Generation Y, 52P Conn



Documents

Product Drawings

[CONTACT,FEMALE0.64,20-22AWG,UNSEAL](#)

English

CAD Files

[3D PDF](#)

3D

Customer View Model

[ENG_CVM_CVM_1924955-1_D.2d_dxf.zip](#)

English

Customer View Model

[ENG_CVM_CVM_1924955-1_D.3d_igs.zip](#)

English

Customer View Model

[ENG_CVM_CVM_1924955-1_D.3d_stp.zip](#)

English

By downloading the CAD file I accept and agree to the [Terms and Conditions](#) of use.

Product Specifications

[Application Specification](#)

English