

# Chirp-IoT™ Wireless Transceiver Module 433/868/915MHz

## SPECIFICATION

Model No.: DL-PAN3028-S

Version: V1.0



With Metal Shield

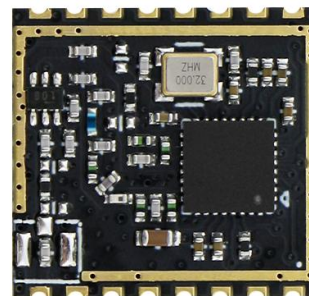

W/O Metal Shield  
(Standard Version)

**Before using this module, please pay attention to the following important matters:**

This module is an electrostatic sensitive product. Please operate it on an anti-static workbench during installation and testing.

This DL-PAN3028-S module uses an external antenna by default, which is intended to be embedded in your product or application, and does not provide a casing itself. The antenna can be a wire antenna or a standard UHF antenna. You can choose a specific antenna according to the actual situation.

Metal objects and wires should be kept away from the antenna as much as possible. If the product uses a metal shell, be sure to install the antenna outside the metal shell. Otherwise, the RF signal will be seriously attenuated, which will affect the effective distance.

**Disclaimer:**

This specification is just for your information, all the charts and pictures used in this specification are for reference only. The actual test shall prevail for details. We do not assume any responsibility for personal injury or property loss caused by user's improper operation.

This specification is subject to change due to the continuous improvement and upgrading of the product version, and the latest version specification shall prevail. DREAMLNK reserves the right of final interpretation and modification of all contents in this specification.

Date	Version	Formulation / Revision of Contents	Approved by
2022-5-1	V1.0	DL-PAN3028-S Standard RF Modules	Fagan Xu

**Copyright © Shenzhen DreamLnk Technology Co., Ltd**

## 1. Module Introduction

### 1.1 Brief Introduction

DL-PAN3028-S is a wireless module designed based on PANCHIP's radio frequency chip PAN3028. It mainly adopts a new generation of Chirp-IoT™ Modulation technology for ultra-long-distance spread spectrum communication. This Wireless module is compact in size, and has the characteristics of ultra-low receiving power consumption, strong anti-interference ability, and longer transmission distance than traditional modulation methods. It can be widely used in various wireless communication fields of the IoT industry.

DL-PAN3028-S wireless module has high receiving sensitivity of -140dBm, ultra-low receiving current and sleep current, the transmit power can be configured through software, and the maximum power can reach +22dBm. Compared with traditional modulation technology, Chirp-IoT™ Modulation technology has obvious advantages in adjustable bandwidth, spread spectrum factor and error correction rate, which solves the problem of distance, anti-interference and power consumption that traditional design schemes cannot take into account at the same time.

### 1.2 Features

- Chirp-IoT™ modulation technology;
- It supports frequency range of 370~600MHz & 740~1200MHz;
- Designed frequency (use recommended frequency to achieve the best RF performance):  
370~600MHz --> 433M module; 740~1200MHz --> 868/915M module;
- The working voltage is 1.8~3.6V, use stable voltage ( $\geq 3.1V$ ) to maximum output power;
- Supported bandwidth: 62.5KHz, 125KHz, 250KHz, 500KHz;
- Supported spreading factor: SF7/SF8/SF9/SF10/SF11/SF12;
- Supported Bit Rates: 4/5, 4/6, 4/7, 4/8;
- Supports fast Channel Activity Detection (CAD);
- Supports low-rate mode;
- Supports 4-line SPI configuration interface;
- Fully integrated frequency synthesizer;
- Operating temperature: -40~85 C;

### 1.3 Typical Application

- Wireless automatic meter reading (water meter, electric meter, gas meter)
- Ultra-long range data communication
- Smart home system
- Intelligent security monitoring
- Smart building
- Industrial controllers, sensors
- Agricultural automation solutions
- Intelligent parking system
- Automotive industry applications
- Supply chain logistics

### 2. Technical Parameter

Parameter	Min.	Typical	Max.	Unit	Remarks
Operating conditions					
Working voltage & IO voltage range	1.8	3.3	3.6	V	@DCDC mode 2V-3.6V, to ensure maximum chip power, stable voltage should $\geq 3.1V$
Working temperature range	-40	25	85	°C	Limit operating range
Current consumption					
Receiving Current	16	18	20	mA	@433 @LDO
	12.5.	13.5	15.5	mA	@433 @DCDC
	12.5	13.5	15.5	mA	@868 @DCDC
	12.5	13.5	15.5	mA	@915 @DCDC
Transmission Current	115	120	125	mA	@433 @LDO
	130	135	140	mA	@433 @DCDC
	135	140	145	mA	@868 @DCDC
	135	140	145	mA	@915 @DCDC
Standby Current	0.1	0.3	0.5	uA	Save via register
RF parameters					
Recommended Frequency (For best performance)	410	433/470	490	MHz	@433MHz RF module
	840	868/915	930	MHz	@868MHz/915Mhz RF module

Transmit Power Range	-7	22	22	dBm	Software configurable
Receiving Sensitivity		-138		dBm	@BW=62.5KHz, SF=12
		-120.5		dBm	@BW=250KHz, SF=7
Payload Rate Range	0.16		21.8	kbps	L: BW:62.5, SF:12, CR:4/5 H: BW:500, SF:7, CR:4/5
Communication Rate Range	0.04	0.04	0.04	kbps	@BW:62.5, SF:12, CR:4/5 (Min. Rate) Payload: 10byte Preamble: 8byte
	20.42	20.42	20.42	kbps	@BW:500, SF:7, CR:4/5 (Max. Rate) Payload: 255byte Preamble: 8byte

Table 1: Technical Parameter

### 3. Pin Definitions

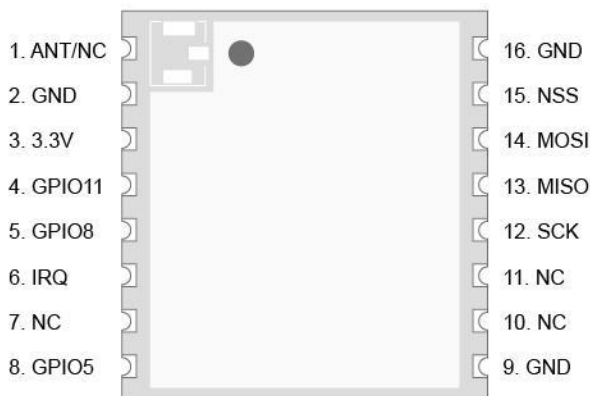

Front Side

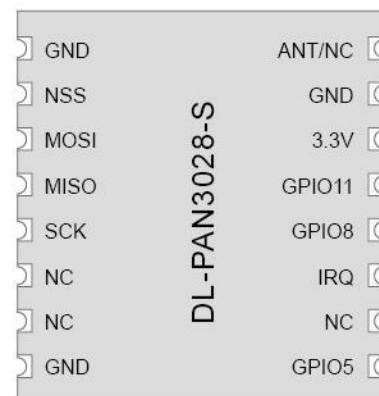

Back Side

No	Definitions	Type	Description
1	ANT/NC		Antenna interface
2	GND	PWR	Reliable grounding
3	3.3V	PWR	Power
4	GPIO11	I/O	Digital I/O port
5	GPIO8	I/O	Digital I/O port
6	IRQ	O	Interrupt Request Pin, high level active
7	NC		No connection

8	GPIO5	IO	Digital I/O port
9	GND	PWR	Reliable grounding
10	NC		No connection
11	NC		No connection
12	SCK	I	SPI Serial Clock Input
13	MISO	O	SPI Master Input Slave Output
14	MOSI	I	SPI Master Output Slave Input
15	NSS	I	SPI Chip Select Input
16	GND	PWR	Reliable grounding

Table 2: Pin Definitions

#### 4. Module Size & SMT

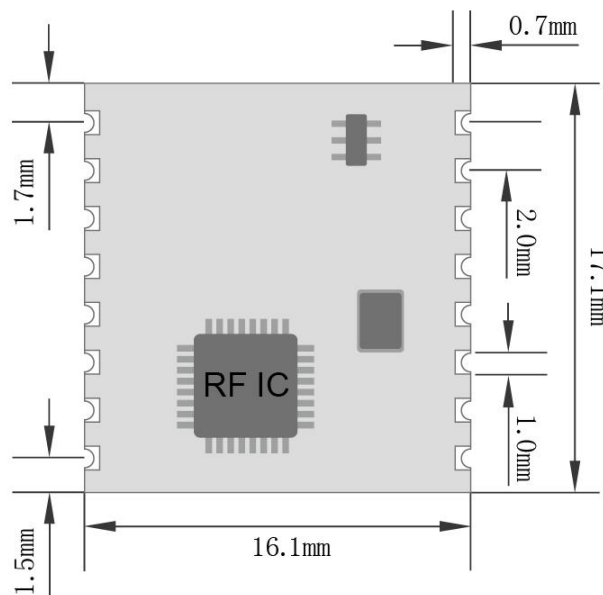

Please apply for module packaging from our technical support: SMT patch package, DIP in-line package file (refer to schematic diagram)

Package files format description:

- \* .ASC format can be opened with Protel99se;
- \* .DXF format can be opened with CAD;
- \* .PCB format can be opened with PADS software;

Module packaging: SMT placement (steel mesh thickness  $\geq 1.2\text{mm}$ )

## 5. Application Connection Diagram

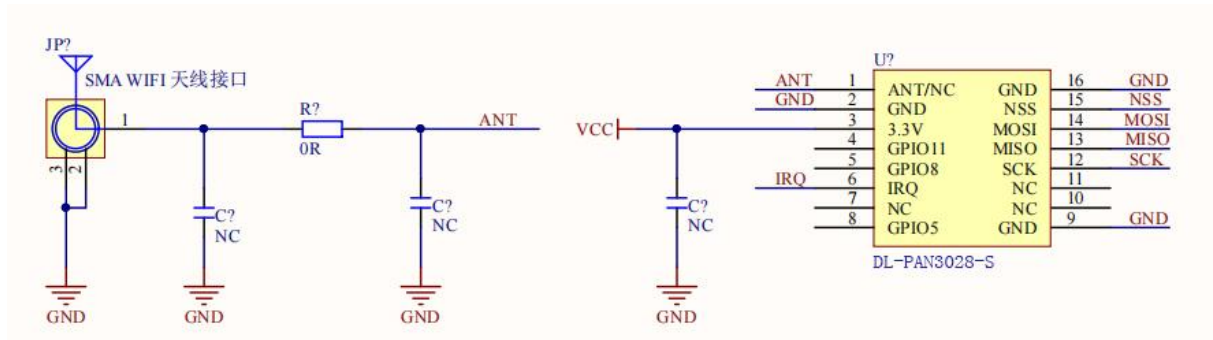

Note: This schematic diagram is for your reference only, it shows the minimum communication connection. The 4-line SPI and IRQ pins need to be connected to the I/O port of the MCU. If you have any question, please contact us for more help.

### 5.1 I/O design

- When doing the hardware design, for the data packet mode (SPI transmission), the general SPI interface, and IRQ interfaces should be connected to the GPIO of the MCU;
- The software obtains the interrupt event of the chip by polling IRQ;
- Regarding the electronic switch of the transceiver mode:  
The chips GPIO1(RXEN) and GPIO3(TXEN) are designed as the switch control of antenna switching by hardware, and the antenna switching is automatically completed inside the module;
- CAD mode is a must, if you want to achieve low power consumption. By default, the SDK sets GPIO11 as the channel status indication signal.

## 6. Circuit Design

### 6.1 Power Supply Design

- Please pay attention to the power supply voltage of the device, exceeding the recommended voltage range may cause function abnormally and permanently damage;
- Try to use a DC stabilized power supply, and the power ripple coefficient should be as small as possible; the power load when transmitting the maximum power needs to be also considered;
- The module needs to be grounded reliably, and a good grounding can achieve better performance output and reduce the impact of RF on other sensitive devices.

### 6.2 RF Routing Design

- The module should be far away from RF interference sources, such as high-frequency circuit

transformer, and it is forbidden to route the wires directly under the module, otherwise it may affect the receiving sensitivity;

- When using the on-board antenna, the antenna needs to be clear on both sides, and the ground should not be too close to the antenna at the same time, otherwise it will absorb the radiated energy;
- Route 50Ω impedance line, lay the ground and drill more ground holes;
- The PCBA space allows to reserve a  $\pi$ -type matching network, first connect it through a 0R resistor, otherwise the antenna is open.

### 6.3 Antenna Design

- There are many types of antennas, choose the appropriate antenna according to your needs;
- Choose a suitable placement position, according to the Antenna polarity, and it is recommended to be vertically upward;
- There should be no metal objects in the antenna radiation path, otherwise the transmission distance will be affected (such as a closed metal casing).

## 7. Software Debugging Process

7.1 The SDK is transplanted according to the demo program, and you can connect the Hal interface according to the MCU you use;

7.2 Make two verification PCB boards to complete the communication verification (both transmitting and receiving), according to the Demo Program;

7.3 After communication normally set up, you need to optimize the modulation parameters, and change the spreading factor, bandwidth and other parameters according to your needs to control the code transmission time (related to the symbol time) and communication distance;

Modulation Bandwidth (BW_L)	The higher the BW, the faster the modulation rate, but the larger the signal bandwidth will reduce the sensitivity of the receiver
Spreading Factor (SF)	The higher SF can increase the sensitivity of demodulation and increase the distance, the disadvantage is that it will greatly increase the transmission time
The Coding Rate (CR)	In the case of severe interference, it can increase the anti-interference, but the disadvantage is that the coding efficiency will be reduced and the baud rate will slow down. Under normal circumstances, the default CR = 4/5 can be used.

**Table 3: Commonly Used Debugging Parameters**

7.4 The maximum transmit power can be +22dbm, to ensure the largest link budget;

7.5 If low power consumption is required, you can use the API interface of the Demo

7.6 In Chirp-IoT™ mode, the corresponding table between the symbol time sent by the spreading factor and the bit rate of the actual payload is as follows:

BW SF	62.5		125		250		500	
	Symbol tim (ms)	Rate (kbps)	Symbol tim (ms)	Rate (kbps)	Symbol tim (ms)	Rate (kbps)	Symbol tim (ms)	Rate (kbps)
7	2.05	2.73	1.02	5.47	0.51	10.94	0.26	21.88
8	4.10	1.56	2.05	3.13	1.02	6.25	0.51	12.50
9	8.19	0.88	4.10	1.76	2.05	3.52	1.02	7.03
10	16.38	0.49	8.19	0.98	4.10	1.95	2.05	3.91
11	32.77	0.27	16.38	0.54	8.19	1.07	4.10	2.15
12	65.54	0.15	32.77	0.29	16.38	0.59	8.19	1.17

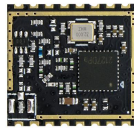
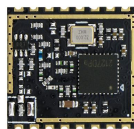
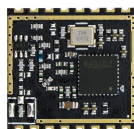



**Table 4: Symbol time and bit rate**

**Note:** The payload data refers to the data you actually transmit, but the actual transmission time includes not only the payload, but also the preamble, the header, its encoding rate, and the check digit of the payload.

## 8. Notice for module application

- (1) This module is an electrostatic sensitive product. Please operate on an anti-static workbench during installation and testing;
- (2) When installing the module, make sure that nearby objects keep a sufficient safe distance from the module to prevent short-circuit damage;
- (3) Liquid substance is not allowed to come into contact with this module, and this module should be used in a dry environment;
- (4) Please use an independent voltage stabilizing circuit to supply power to this module, and avoid sharing with other circuits. The tolerance of the power supply should not be less than 5%.
- (5) The indicators of this module are accord to commonly used international standard. If special certifications needed, we can adjust certain indicators according to your needs.

## 9. Model Selection Table:

Model No.	Picture	Feature	Frequency
DL-PAN3028-S-433		W/O Metal Shield	433MHz
DL-PAN3028-S-868		W/O Metal Shield	868MHz
DL-PAN3028-S-915		W/O Metal Shield	915MHz
DL-PAN3028-S-433S		With Metal Shield	433MHz
DL-PAN3028-S-868S		With Metal Shield	868MHz
DL-PAN3028-S-915S		With Metal Shield	915MHz

## 10. Contact us

### Shenzhen DreamLnk Technology Co., Ltd

★ Data collection, Smart home, Internet of Things applications, Wireless remote control technology, Remote active RFID, Antennas ★

Office Add.: Room 603, Unit C, Zone A, Huameiju Business Center, Xihu Rd., Bao'an District, Shenzhen, Guangdong Province, China

Factory Add.: Huazhi Innovation Valley, No. 7 Yuhua Street, 138 Industrial Zone, Tangxia Town, Dongguan, Guangdong Province, China