



承認書

Specification For Approval

Customer: (客戶)

Description: (產品描述)

SMD3030燈珠0.5W紅光

Part number: (產品型號)

TJ-S3030UG5W6TLC2R-A5

Date: (日期)

Approved By: (客戶承認)

--

Prepared By: (我司承認)

Approval	Check	Design	Sales

核准

審核

製作

業務

Customer Service Hotline: **400-676-8616**

TEL: 0769-8662 5999 0769-8200 2226

E-MAIL : dg@togialed.com

FAX: 0769-8200 2227

WEB: www.togialed.com

※产品特征 Features

- 1.外型尺寸: 3.0×3.0×0.6mm
Outline Package: 3.0×3.0×0.6mm(Top View White LED)
- 2.发光颜色: 红光
EmittedColor:Red
- 3.封装胶水: 硅胶
Encapsulating Resin: Silicon Resin
- 4.适用于所有表面贴装技术组装生产
Suitable for all SMT assembly methods
- 5.完全符合 ROHS 指令
Comply with RoHS

※产品应用 Applications

1. 室内室外显示屏 光学指示
Indoor and outdoor displays
2. 背光
Backlighting
3. 汽车内部照明
Interior automotive lighting
4. 信号照明
Signal and symbol luminaire

※外型尺寸图 Package Outline Dimensions

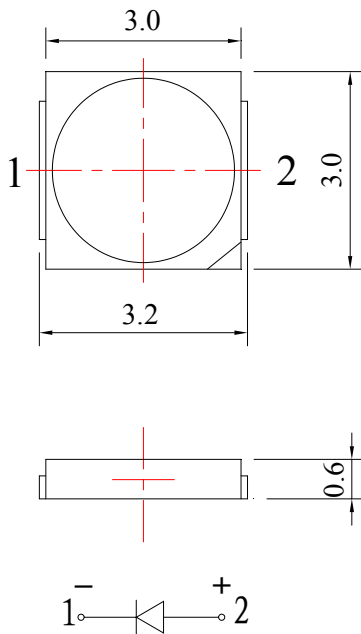

焊盘设计 PAD Lay Out PCB

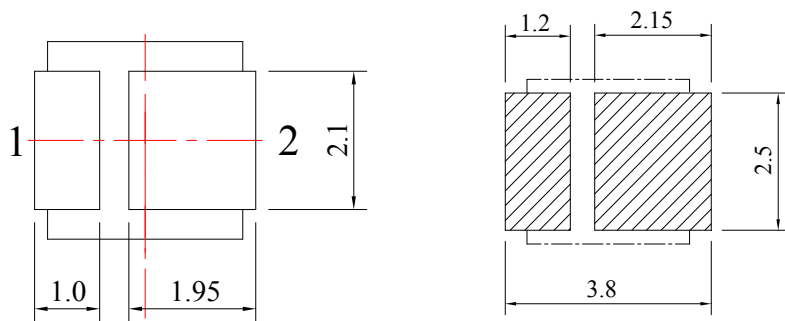

1. All dimensions are in millimeters (inches);

单位: 毫米 (英寸)

2. Tolerances are ±0.2mm (0.008inch) unless otherwise noted.

未标公差处公差为 0.2mm(0.008 英寸)



ATTENTION
OBSERVE PRECAUTIONS
FOR HANDLING
ELECTROSTATIC
SENSITIVE DEVICES

最大绝对额定值 Absolute maximum ratings at Ta=25°C

参数名称 Parameter	符号 Symbol	数值 Value	单位 Unit
功率耗损 Powerdissipation	PD	390	mW
正向电流 Forward current	I _F	150	mA
脉冲电流[1] Peak pulsing current	I _{FP}	300	mA
最大反向电压 [2] Reverse Voltage	V _R	5	V
工作温度范围 Operatingtemperaturerange	Topr	-20~80	°C
贮存温度范围 Storagetemperaturerange	Tstg	-30~80	°C
最大节点温度 Junction Temperature	TJ	105	°C
回焊条件 ReflowSolderingCondition	Tsid	260/5sMax.	°C

[1] 无齐纳时反向电压项目有效 It is available when without zener on VR

[2] I_{FP} 条件: 脉冲持续时间 ≅ 10msec, 占空因素 ≅ 1/10

I_{FP} Conditions: Pulse Width ≅ 10msec. and Duty cycle ≅ 1/10

电光特性 Electrical-optical characteristics at Ta=25°C

参数名称 Parameter	符号 Symbol	测试条件 Test conditions	Min.	Typ.	Max.	单位 Unit
正向电压 Forward voltage	V _F	I _F = 150mA	1.8	-	2.6	V
光通量 luminous flux	φ	I _F = 150mA	15	-	25	LM
主波长 Wave Length	d	I _F = 150mA	620	-	630	NM
峰值波长 Peak wave length	p	I _F = 150mA	-	631	-	NM
反向电流 Reverse Current	I _R	V _r = 5V	-	-	5	uA
半功率角 Viewing angle at 50% I _v	2θ _{1/2}	I _F = 150mA	-	120	-	deg

1. Tolerance of luminous flux is ±10%

光通量公差为±10%

2. Tolerance of forward voltage is ±0.05V

正向电压公差±0.05v

典型光电参数曲线 Typical Electrical / Optical Characteristics Curves (Ta=25°C)

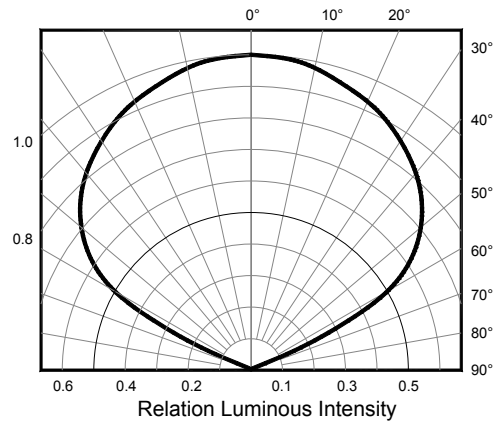
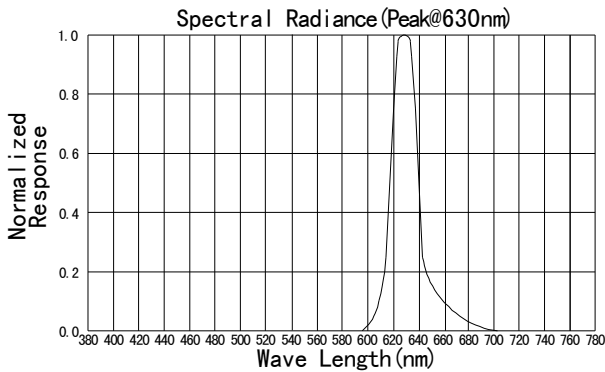

Radiation Diagram

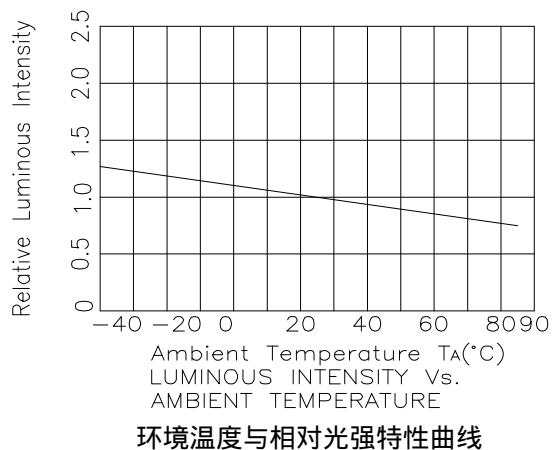
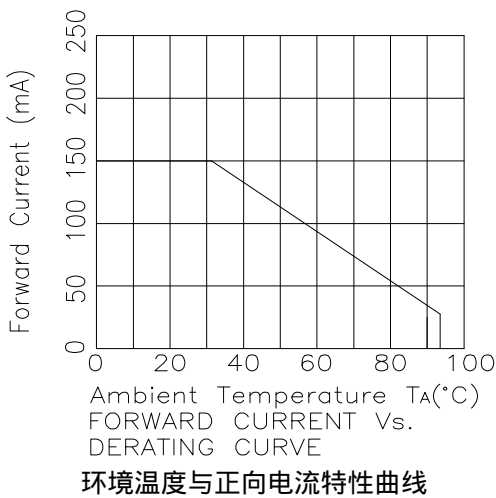
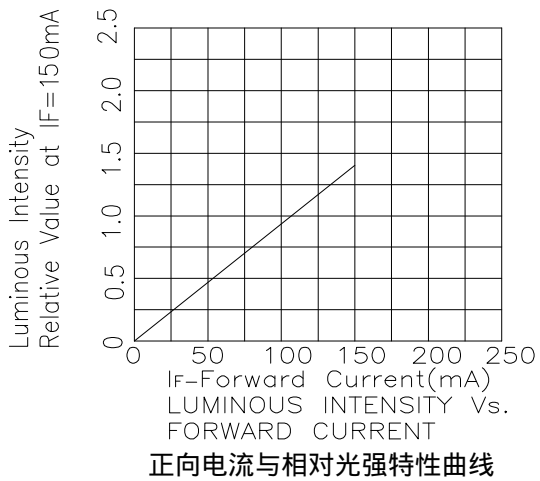
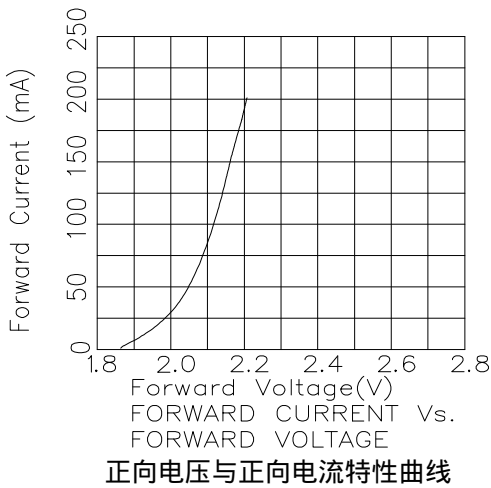

Test items and results of reliability 可信赖度测试

Type	Test Item	Test Conditions	Note	Number of Damaged
Environmental Sequence	Temperature Cycle 高低温循环	-20°C 30min ↑ ↓ 80°C 30min	100 cycle	0/22
	Thermal Shock 冷热冲击	-20°C 15min ↑ ↓ 80°C 15min	100 cycle	0/22
	High Humidity Heat Cycle 高湿度热循环	30°C ↔ 65°C 90%RH 24hrs/1cycle	10 cycle	0/22
	High Temperature Storage 高温贮存	T _a =80°C	1000 hrs	0/22
	Humidity Heat Storage 高湿度热贮存	T _a =60°C RH=90%	1000 hrs	0/22
	Low Temperature Storage 低温贮存	T _a =-30°C	1000 hrs	0/22
Operation Sequence	Life Test 寿命试验	T _a =25°C I _F =150mA	1000 hrs	0/22
	High Humidity Heat Life Test 高湿度热寿命试验	50°C RH=90% I _F =150mA	500 hrs	0/22
	Low Temperature Life Test 低温寿命试验	T _a =-20°C I _F =150mA	1000 hrs	0/22

注意事项 Precautions for use

回流焊规范 Reflow Profile

无铅产品回流焊温度条件曲线规范 Pb-free Solder temperature Profile

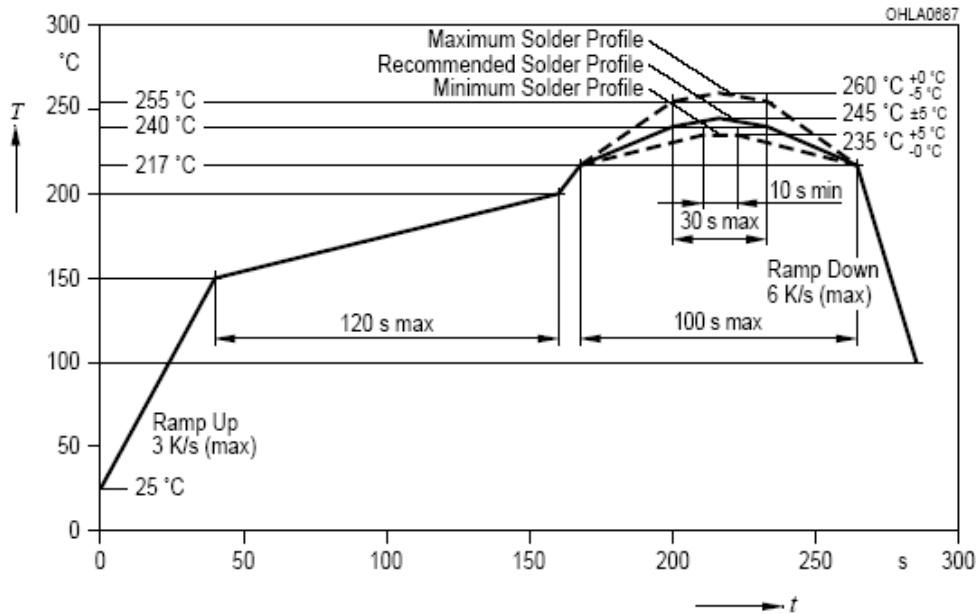

Note: a) 材料焊接次数不超过2 次。

Reflow soldering should not be done more than two times.

b) 焊接时请不要重压LED 灯。

Do not put stress on the LEDs when soldering.

c) 焊接后温度未回降到常温时请勿扭曲线路板。

Do not warp the circuit board before it have been returned to normal ambient conditions after soldering.

手工焊接规范 Hand Soldering Profile

手工焊接时，烙铁温度不高于300℃，每个焊脚焊接时间不超过3 秒，只能焊接一次。（不建议手工焊接）。

The temperature of the iron should be lower than 300℃ and soldering within 3sec per solder-pad is to be observed. The hand solder should be done only one times. (Not recommended by welding)

贮存规范 Storage Profile

1. 请在未准备使用LED 之前不要打开防静电袋子。

Do not open the moisture proof bag before ready to use the LEDs.

2. LED 在未开封之前应保存在30℃以下，湿度在60%以下的环境中，最长保存期为1 年。

The LEDs should be kept at 30℃ or less and 60%RH or less before opening the package.

The max. storage period before opening the package is 1 year.

3. 打开包装待后，LED 需保存在30℃/40%湿度以下的条件，且必须在3天内使用完。

After opening the package, the LEDs should be kept at 30℃/40%RH or less, and it should be used within 3 days.

4. 如果 LED 超出了第 3 点要求，则 LED 必须经过烘烤才能使用，烘烤条件为：70±5℃,8 个小时。

If the LEDs be kept over the condition of 3, baking is required before mounting. Baking condition as below: 70±5℃ for 8 hours.

处理预防 Handling precautions

1. 处理元件沿着端面借用镊子或适当工具

.Handle the component along the side surface by using forceps or appropriate tools

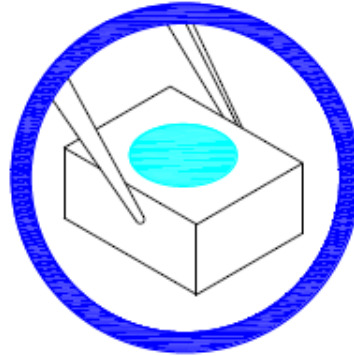

2. 不直接用手或工具接触硅胶或透镜表面，它可能损害内部电子线路

Do not directly touch or handle the silicone lens surface. It may damage the internal circuitry

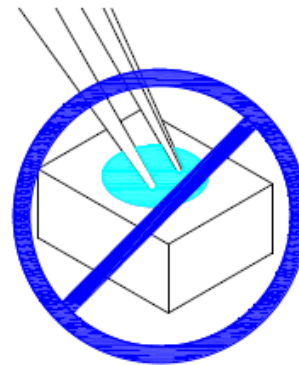
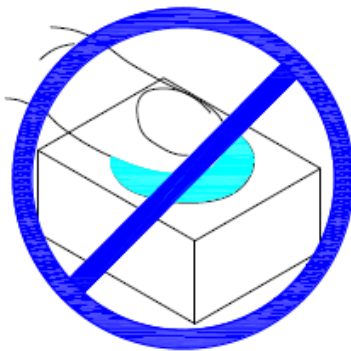

3. 不将发光二极管叠堆一起，它可能会刮损硅胶或透镜

Do not stack together assembled PCBs containing LEDs. Impact may scratch the silicone lens or damage

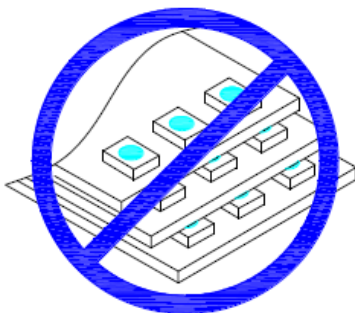

4. 不适合在酸性的环境中使用

Not available in the situation of acidity for PH



