

REVISIONS					
REV.	ECN NO.	LOCATION	DESCRIPTION	DATE	DESIGN
A1	N/A			2025.06.06	
A2	ECN-P-2026030401	(A2)X1		2026.03.04	

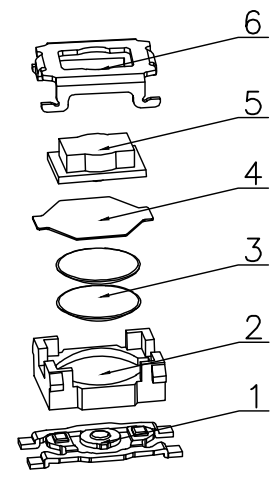

SPECIFICATION
 Contact Rating 50mA,12V DC
 Contact Resistance 100mΩ max
 Insulation Resistance 100MΩ min.500V DC
 Dielectric Strength 250V AC/1minute
 Travel 0.18±0.10mm
 Operating Temp -40 ~+85

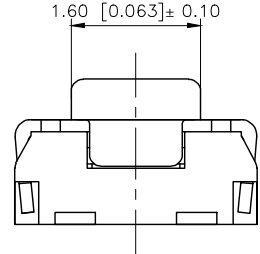
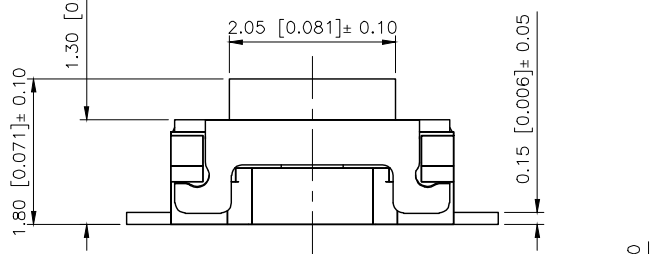
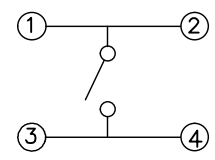
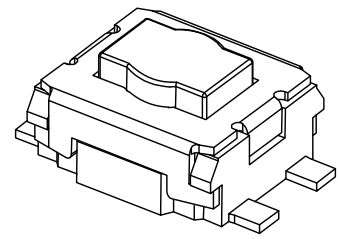
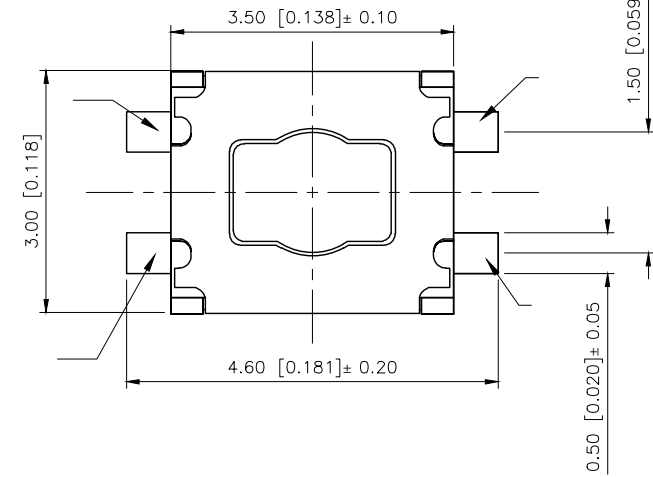

Circuit Diagram

PAPT NO	TS-1809SM-X
Operating Force	A:100gf B:160gf C:260gf

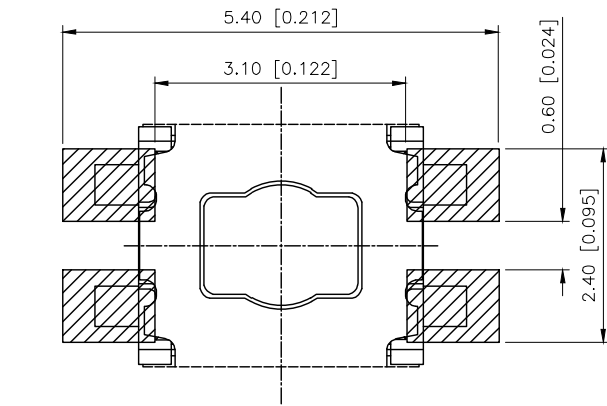

P.C.B LAYOUT

ITEM	PAPT NAMF	QTY	MATERIAL	FINISHING
	Cover	1	SUS304	
	Button	1	LCP	Black
	Dustproof film	1	PI	Yellow
	Terminal	1/2	SUS301	Plating silvering
	Base	1	LCP	Black
	Cards	1	Phosphor Bronze	Plating Nickel

AuGLAR	±5°
X.	±0.40
X.x	±0.30
X.xx	±0.20
X.xxx	±0.15
UNSPECIFIED TOLERANCES	



DESIGN		VIEW:	MODEL TYPE: TACT SWITCH
CHECKED		UNIT: mm/in	PART NO.: TS-1809SM-X
APPROVED		SIZE: A4	DWG NO.:

XKB INDUSTRIAL PRECISION CO.,LIMITED

SCALE	PAGE	REVISION
N/A	1/1	A2