

Right Angle Mount Thru Hole PCB Nano Connectors feature gold alloy TwistPin contacts. These nanominiature connectors offer premium performance and reliability for demanding applications. Available with female threads, or with jackscrews for use with printed circuits boards.

Pre-Tinned PC Tails are coated with Sn63Pb37 or Sn60Pb40 tin-lead for

excellent solderability.

Choose Aluminum, Titanium or Stainless Steel Shells in eleven layouts from 9 to 85 contacts. Complies to the requirements of MIL-DTL-32139. These connectors are intermateable with any M32139 compliant connector or Glenair Series 891 Dual row metal shell nanominiature connector.

How to Order						
Sample Part Number	891-009	-25S	A2	-BRT	1	T
Series	891-008 Plug, Right Angle PCB Connector 891-009 Receptacle, Right Angle PCB Connector					
Insert Arrangement/ Contact Type	Pins (891-008 Plugs): 9P, 15P, 21P, 25P, 31P, 37P, 41P, 51P, 65P, 69P, 85P Sockets (891-009 Receptacles): 9S, 15S, 21S, 25S, 31S, 37S, 41S, 51S, 65S, 69S, 85S					
Shell Material and Finish	A1 - Aluminum Shell, Cadmium Plating A2 - Aluminum Shell, Electroless Nickel Plating		T - Titanium Shell, Unplated S - Stainless Steel Shell, Passivated			
Termination Type	BRT - Board Right Angle Thru Hole					
PC Tail Length	1 - .110 (2.79)	2 - .172 (4.37)	3 - .140 (3.56)			
Hardware	J - Hex Head Jackscrew		T - Female Thread			

D

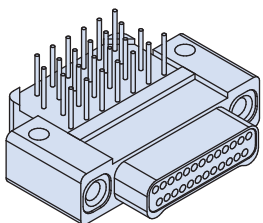
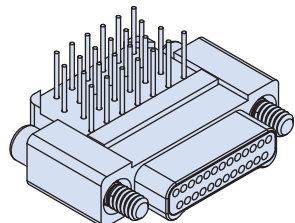
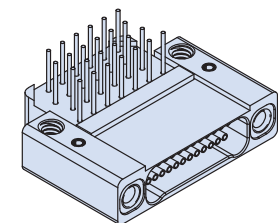
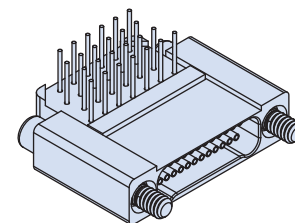
Plug (Pin) Connector		Receptacle (Socket) Connector	
			
T - Female Thread Option	J - Jackscrew Option	T - Female Thread Option	J - Jackscrew Option

NOTES

- Inspect and test IAW MIL-DTL-32139
- Interface dimensions per MIL-DTL-32139/3 and /4
- Materials/finishes
 - Shell: see part number break down
 - Insulator: LCP/N/A
 - Contacts: gold alloy per ASTM B477 and ASTM B541
 - Pre-tinned PC tails: coated with Sn63Pb37 or Sn60Pb40 tin-lead
 - Hardware: passivated stainless steel

DETAIL B

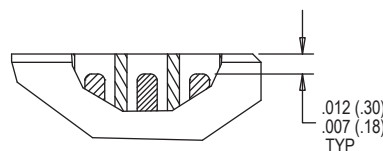

DETAIL A

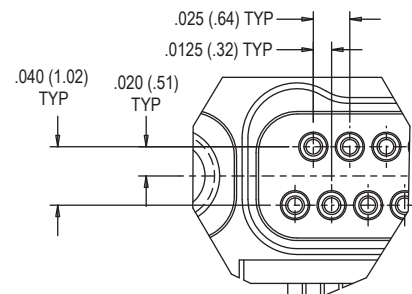

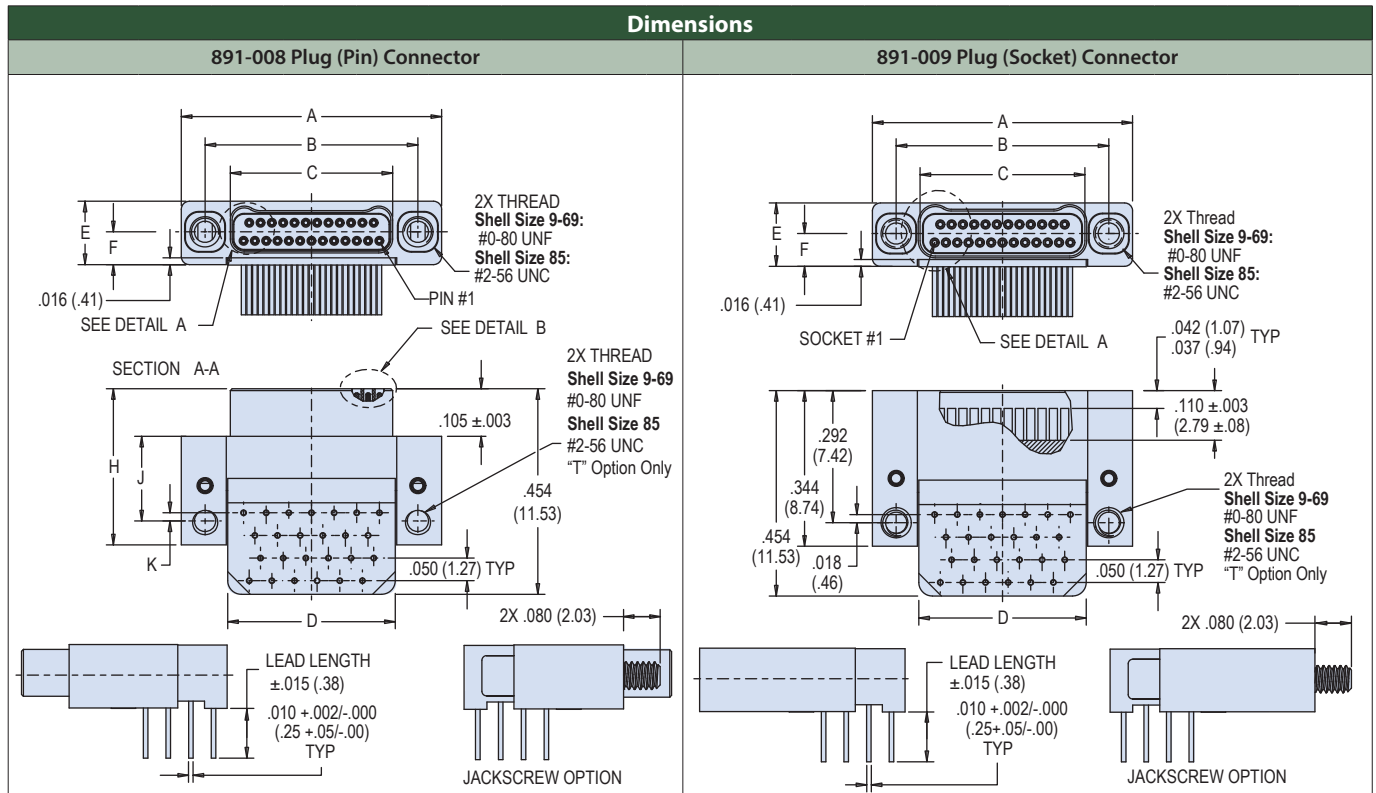

Size	A		B BSC.		C BSC.		D		E		F		H		J		K	
	In.	mm.	In.	mm.	In.	mm.	In.	mm.	In.	mm.	In.	mm.	In.	mm.	In.	mm.	In.	mm.
9P	.375	9.52	.270	6.86	.160	4.06	.170	4.32	.140	3.56	.0725	1.84	.344	8.74	.187	4.75	.018	.46
9S	.375	9.53	.270	6.86	.163	4.14	.170	4.32	.140	3.56	.0725	1.84	--	--	--	--	--	--
15P	.450	11.43	.345	8.76	.235	5.97	.245	6.22	.140	3.56	.0725	1.84	.344	8.74	.187	4.75	.018	.46
15S	.450	11.43	.345	8.76	.238	6.05	.245	6.22	.140	3.56	.0725	1.84	--	--	--	--	--	--
21P	.525	13.33	.420	10.67	.310	7.87	.320	8.13	.140	3.56	.0725	1.84	.344	8.74	.187	4.75	.018	.46
21S	.525	13.34	.420	10.67	.313	7.95	.320	8.13	.140	3.56	.0725	1.84	--	--	--	--	--	--
25P	.575	14.60	.470	11.94	.360	9.14	.370	9.40	.140	3.56	.0725	1.84	.344	8.74	.187	4.75	.018	.46
25S	.575	14.61	.470	11.94	.363	9.22	.370	9.40	.140	3.56	.0725	1.84	--	--	--	--	--	--
31P	.650	16.51	.545	13.84	.435	11.05	.445	11.30	.140	3.56	.0725	1.84	.344	8.74	.187	4.75	.018	.46
31S	.650	16.51	.545	13.84	.438	11.13	.445	11.30	.140	3.56	.0725	1.84	--	--	--	--	--	--
37P	.725	18.41	.620	15.75	.510	12.95	.520	13.21	.140	3.56	.0725	1.84	.344	8.74	.187	4.75	.018	.46
37S	.725	18.42	.620	15.75	.513	13.03	.520	13.21	.140	3.56	.0725	1.84	--	--	--	--	--	--
41P	.775	19.69	.670	17.02	.560	14.23	.570	14.48	.140	3.56	.0725	1.84	.344	8.74	.187	4.75	.018	.46
41S	.775	19.69	.670	17.02	.563	14.30	.570	14.48	.140	3.56	.0725	1.84	--	--	--	--	--	--
51P	.900	22.86	.795	20.19	.685	17.40	.695	17.65	.140	3.56	.0725	1.84	.344	8.74	.187	4.75	.018	.46
51S	.900	22.86	.795	20.19	.688	17.48	.695	17.65	.140	3.56	.0725	1.84	--	--	--	--	--	--
65P	1.075	27.30	.970	24.64	.860	21.84	.870	22.10	.140	3.56	.0725	1.84	.344	8.74	.187	4.75	.018	.46
65S	1.075	27.31	.970	24.64	.863	21.92	.870	22.10	.140	3.56	.0725	1.84	--	--	--	--	--	--
69P	1.125	28.57	1.020	25.91	.910	23.11	.920	23.37	.140	3.56	.0725	1.84	.344	8.74	.187	4.75	.018	.46
69S	1.125	28.58	1.020	25.91	.913	23.19	.920	23.37	.140	3.56	.0725	1.84	--	--	--	--	--	--
85P	1.377	34.97	1.246	31.65	1.110	28.19	1.120	28.45	.165	4.19	.0825	2.10	.410	10.41	.244	6.20	.075	1.91
85S	1.377	34.98	1.246	31.65	1.113	28.27	1.120	28.45	.165	4.19	.0825	2.10	--	--	--	--	--	--



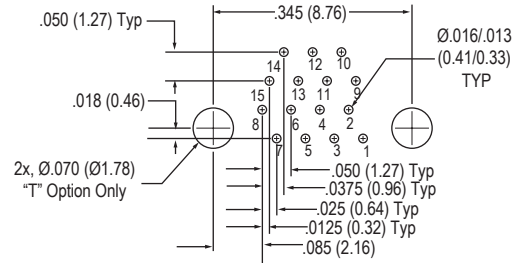
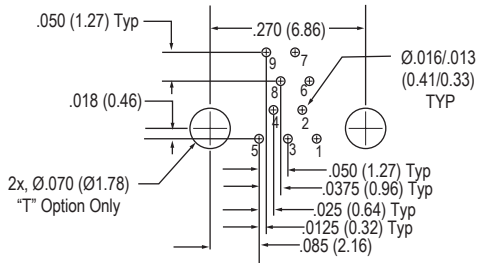
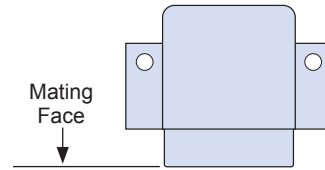
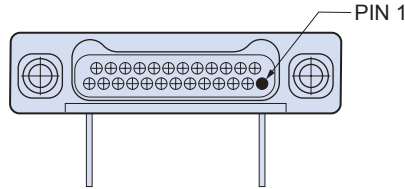

9 Contacts

15 Contacts

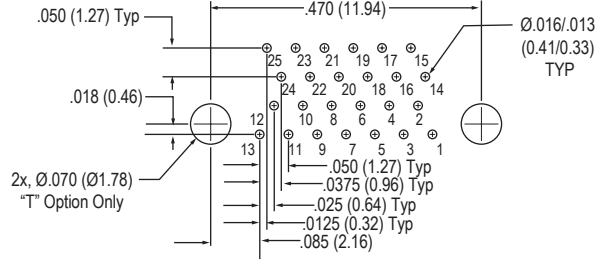
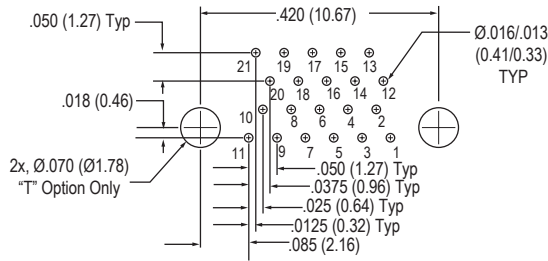

21 Contacts

25 Contacts

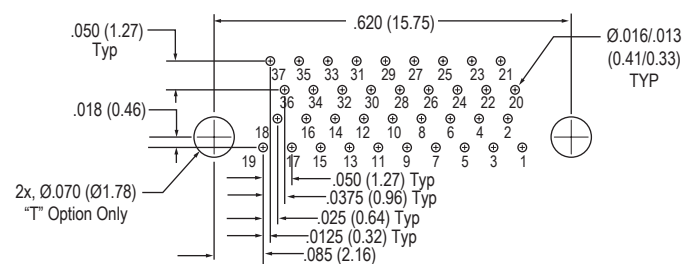
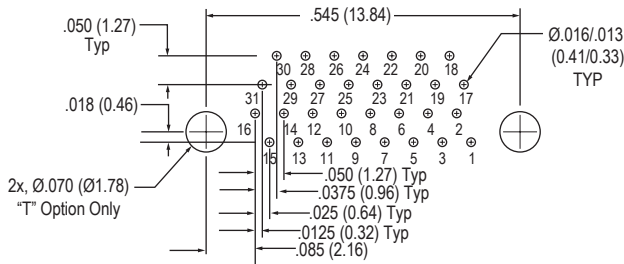

31 Contacts

37 Contacts

Layouts shown are for connector mounting side of PC Board.

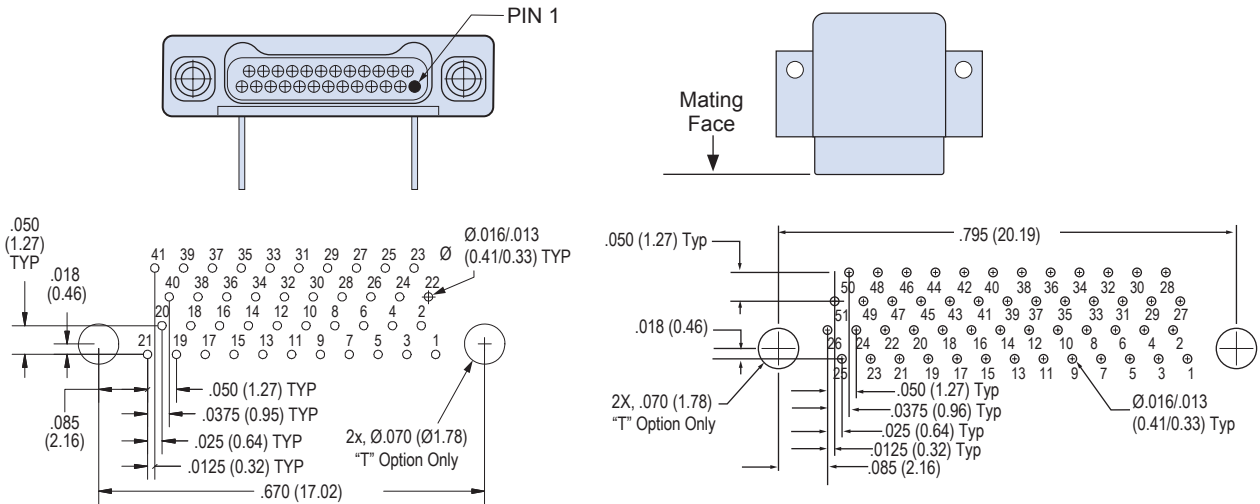

41 Contacts

51 Contacts

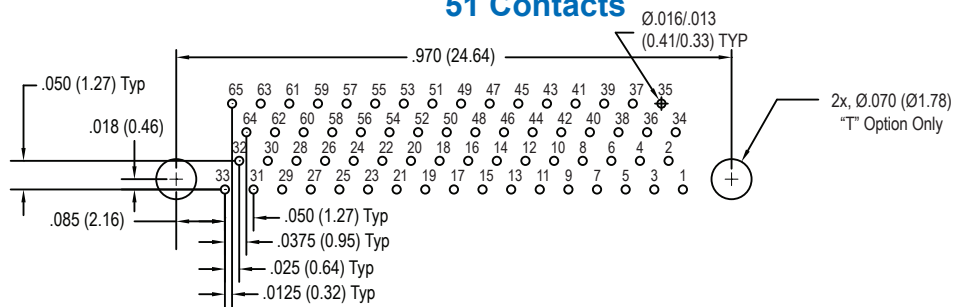

65 Contacts

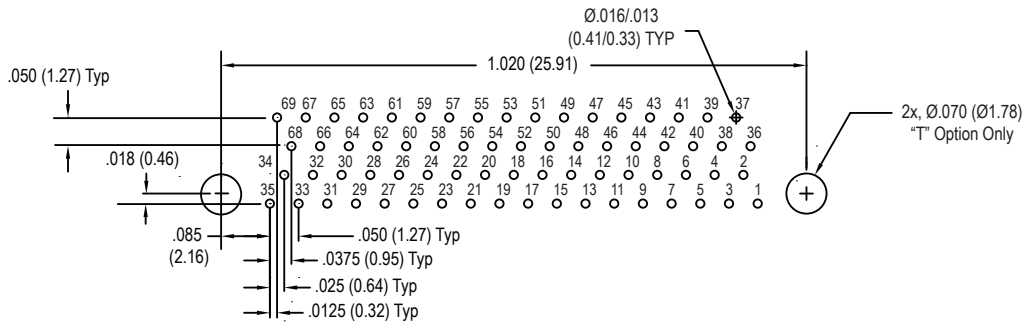

69 Contacts

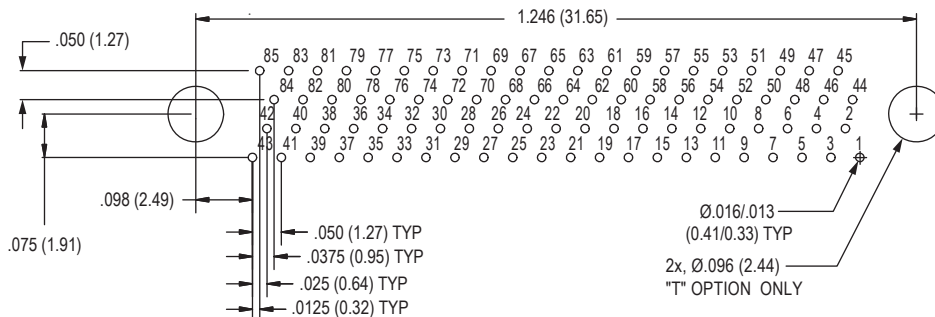

85 Contacts

Layouts shown are for connector mounting side of PC Board.

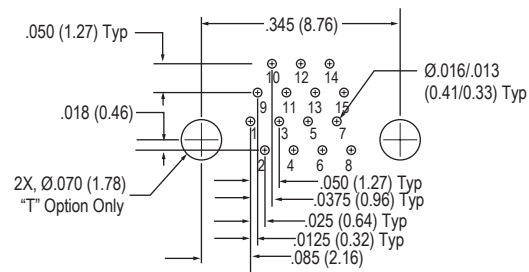
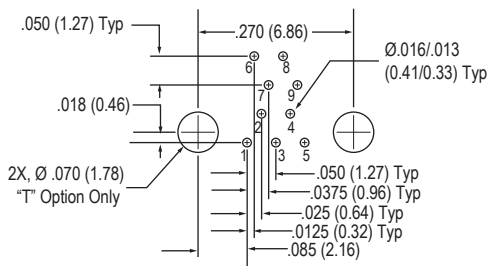
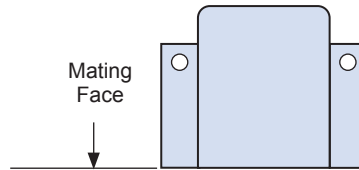
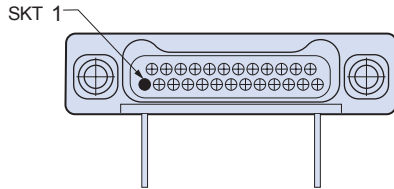

9 Contacts

15 Contacts

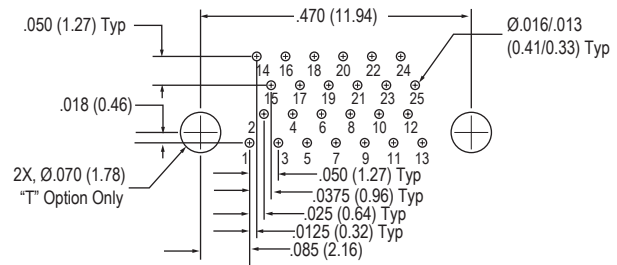
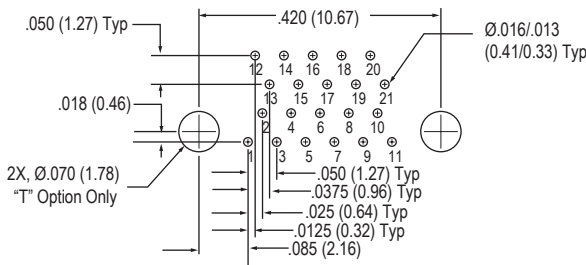

21 Contacts

25 Contacts

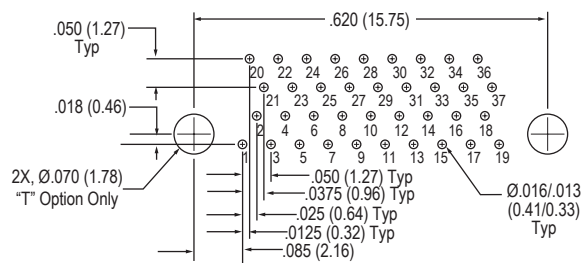
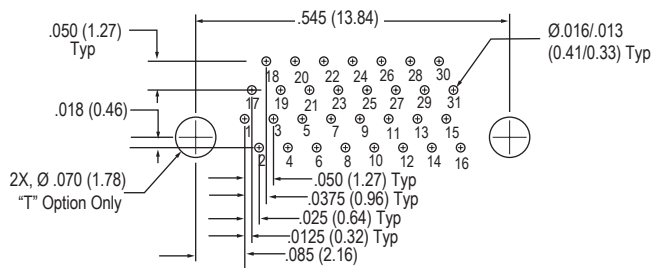

31 Contacts

37 Contacts

Layouts shown are for connector mounting side of PC Board.

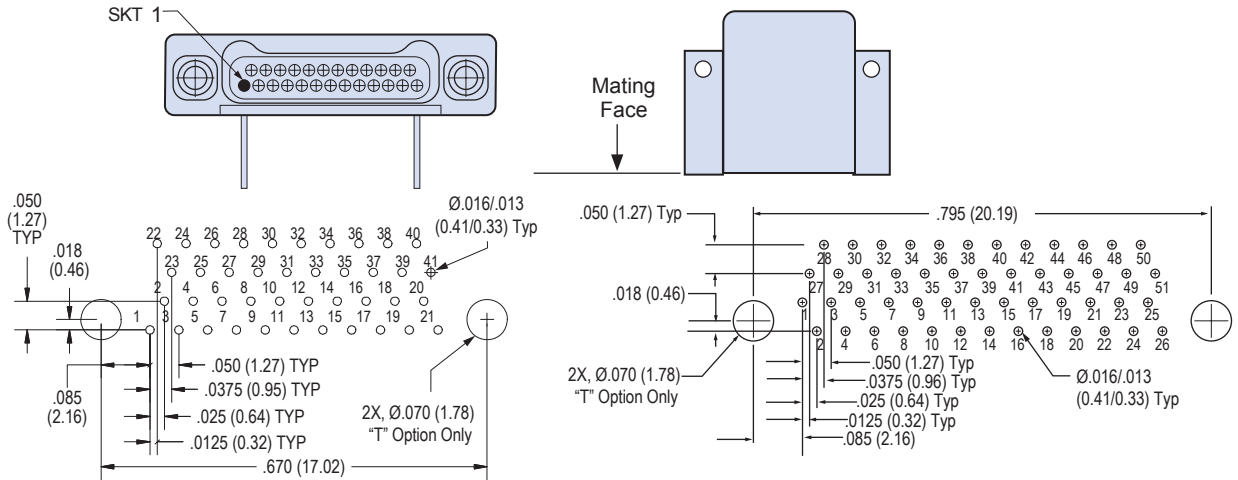

41 Contacts

51 Contacts

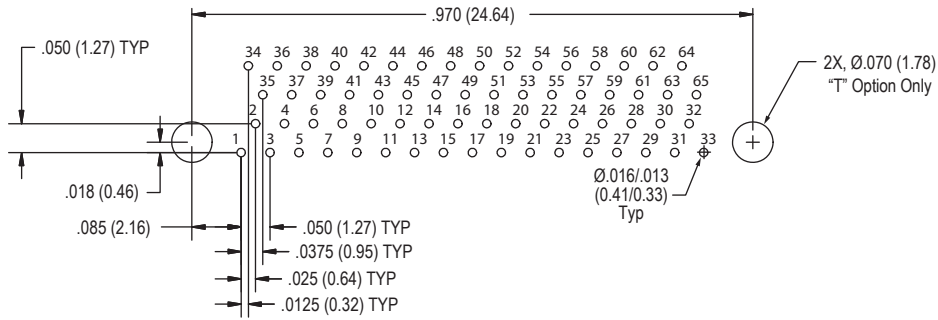

65 Contacts

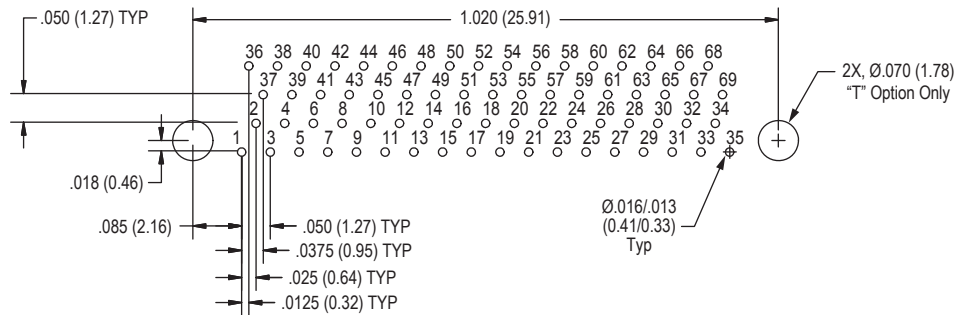

69 Contacts

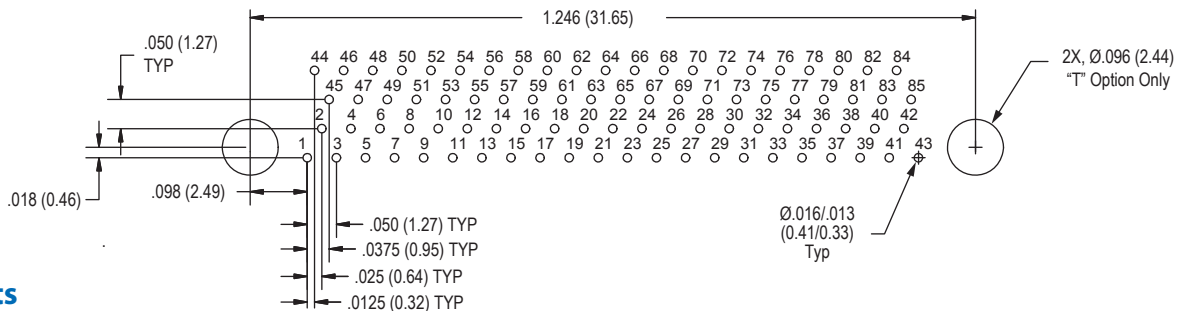

85 Contacts

Layouts shown are for connector mounting side of PC Board.

