



**High Performance, Hall Effect-Based  
Current Sensor IC with a Low-Resistance Conductor  
5A/10A/20A/25A/30A/40A/50A series**

---

**FEATURES**

- ◆ Zero current output voltage is 50%VCC
- ◆ Current sensing range available: 5A/10A/20A/25A/30A/40A/50A
- ◆ High isolation and withstand voltage (3500V<sub>RMS</sub> isolation voltage between pins 1-4 and 5-8)
- ◆ Less power loss, internal conductor's resistance is 0.9mΩ
- ◆ High bandwidth, up to 250KHz
- ◆ 1.2μs output rise time in response to step input current
- ◆ Total output error ±0.5% at T<sub>a</sub>=25°C and ±3% at T<sub>a</sub>=-40~125°C
- ◆ Tokmas<sup>®</sup> patented temperature compensation
- ◆ Outputs desensitized to mechanical stress
- ◆ Differential Hall structure, strong resistance to external magnetic interference
- ◆ ESD (HBM) 4000V
- ◆ Operating ambient temperature: -40~125°C

**APPLICATIONS**

- ◆ Motor controller
- ◆ Load detection and management
- ◆ Switch-mode power supplies
- ◆ Over-current fault protection
- ◆ Other applications requiring current detection

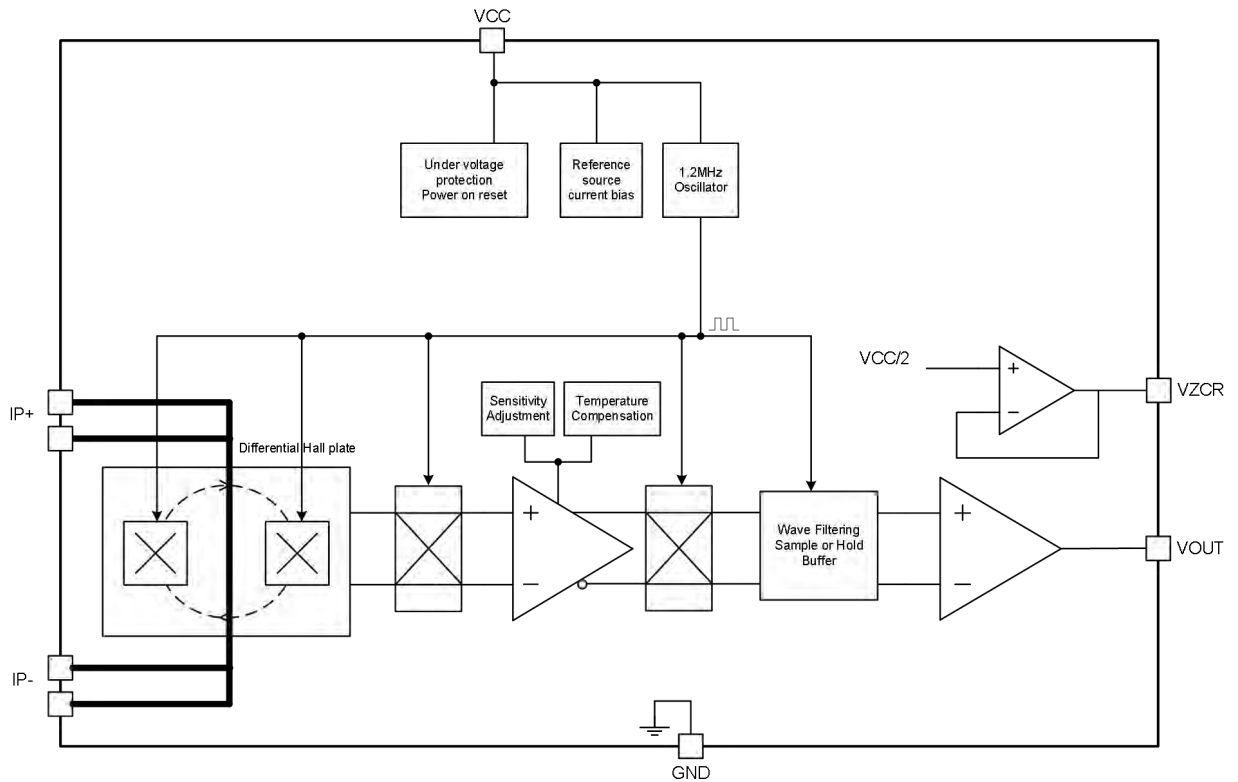
**FUNCTION BLOCK DIAGRAM**

**ORDERING INFORMATION**

Part No.	SENS. (mV/A)	Package	Packing Form
CI5930-5A	400	SOP8	tape reel, 2000 pcs/reel
CI5930-10A	200	SOP8	tape reel, 2000 pcs/reel
CI5930-20A	100	SOP8	tape reel, 2000 pcs/reel
CI5930-25A	80	SOP8	tape reel, 2000 pcs/reel
CI5930-30A	67	SOP8	tape reel, 2000 pcs/reel
CI5930-40A	50	SOP8	tape reel, 2000 pcs/reel
CI5930-50A	40	SOP8	tape reel, 2000 pcs/reel
CI5930-XXA(Note1)	-	SOP8	tape reel, 2000 pcs/reel

**Note 1:** When XXA is within the range of 50A, customers can customize the range according to their needs.

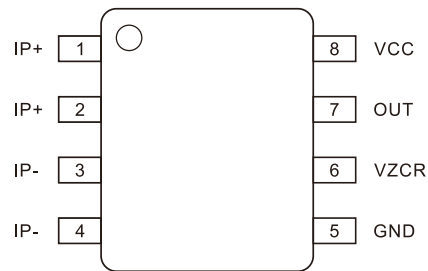
## PINOUT DIAGRAM



SOP8 Package

Name	Number	Description	Name	Number	Description
IP+	1	Current Sampled +	GND	5	Ground
IP+	2	Current Sampled +	VZCR	6	Zero Current Reference Signal Output
IP-	3	Current Sampled -	OUT	7	Analog Voltage Output
IP-	4	Current Sampled -	VCC	8	Power Supply

## ABSOLUTE MAXIMUM RATINGS

Parameter	Symbol	Value	Unit
Power Supply	$V_{CC}$	7	V
Output Voltage	$V_{OUT}$	-0.3~VCC+0.3	V
Output Source Current	$I_{OUT(SOURCE)}$	6	mA
Output Sink Current	$I_{OUT(SINK)}$	30	mA
Input current peak current (3 s)	$I_{PEAK}$	100	A
Input current continuous current	$I_{CON}$	40	A
Isolation Voltage	$V_{ISO}$	3500	VAC
Operating Ambient Temperature	$T_a$	-40~125	°C
Junction Temperature	$T_J$	165	°C
Storage Temperature	$T_s$	-55~150	°C
Magnetic Flux Density	B	Not Limited	mT
Electrostatic Discharge Voltage (HBM)	ESD(HBM)	4000	V

**Note:** Stresses beyond those listed under *Absolute Maximum Ratings* may cause permanent damage to the device. Exposure to absolute-maximum-rated conditions for extended periods may affect device reliability.

## ISOLATION CHARACTERISTICS

Parameter	Symbol	Test Conditions	Value	Unit
Withstand isolation voltage	$V_{ISO}$	Test method: 50 / 60Hz, 1min	3500	$V_{RMS}$
	$V_{TEST}$	t = 1s (100% production)	3900	$V_{RMS}$
Working voltage of basic insulation	$V_{WFSI}$	Basic insulation UL standard 62368-1:2014	600	$V_{PK}$
			424	$V_{RMS}$
Clearance	$D_{cl}$	minimum distance through air from IP leads to signal leads	3.8	mm

**Continued:**

Parameter	Symbol	Test Conditions	Value	Unit
Maximum repetitive peak isolation voltage	$V_{IORM}$	AC voltage (bipolar)	600	$V_{PK}$
Maximum working isolation voltage	$V_{IOWM}$	AC voltage (sine wave)	424	$V_{RMS}$
		DC voltage	600	$V_{DC}$
Maximum transient isolation voltage	$V_{IOTM}$	Test method: $t = 60s$ (qualification)	4949	$V_{PK}$
	$V_{TEST}$	$t = 1s$ (100% production)	5515	
Maximum surge isolation voltage (Note 1)	$V_{IOSM}$	Tested 1.2 $\mu s$ (rise) / 50 $\mu s$ (width) One time	7000	$V_{PK}$
Surge Current (Note 2)	$I_{SURGE}$	Tested in compliance to IEC 61000-4-5 8 $\mu s$ (rise) / 20 $\mu s$ (width)	7.5	kA

**Note1:** Testing is carried out in air to determine the intrinsic surge immunity of the isolation barrier.

**Note2:** Certification pending.

**RECOMMENDED OPERATING CONDITIONS**

Parameter	Symbol	Min.	Max.	Unit
Input voltage (Note 1)	VIN+, VIN- (Note 1)	-600	600	$V_{PK}$
Input current (DC / AC RMS) (Note 2)	IP	-50	50	A
Power Supply	$V_{CC}$	4.5	5.5	V
Operation Temperature	$T_A$	-40	125	$^{\circ}C$

**Note 1:** Vin +, VIN – refers to the voltage of current input pins IP + and IP -, relative to pin 5 (GND).

**Note 2:** Decrease due to higher ambient temperature.

**ELECTRICAL PARAMETERS** ( $T_a=25^{\circ}C$  and  $V_{CC}=5V$ , unless otherwise specified)

Parameter	Symbol	Conditions	Min.	Typ.	Max.	Unit
Power Supply	$V_{CC}$	-	4.5	-	5.5	V
Supply Current	$I_{CC}$	OUT pin floated	-	20	25	mA
Internal benchmark	VZCR		2.470	2.500	2.530	V
Zero Current Output Voltage	$V_{OUT(Q)}$	IP=0	2.490	2.500	2.510	V
Output Capacitance Load	$C_L$		-	-	1	nF
Output Resistive Load	$R_L$		1.5	-	-	k $\Omega$
Res. of Primary Conductor	$R_P$	IP=2A	-	0.9	1.2	m $\Omega$
Propagation Time	$t_D$			1	2	$\mu s$
Rise Time	$t_r$		-	1	2.2	$\mu s$
Common Mode Rejection Ratio	CMRR		38	-	-	dB
Bandwidth	BW	-3dB	250	-	-	kHz
Reference Output Source Current	$I_{ZCR(SOURCE)}$		-	-	400	$\mu A$
Reference Output Sink Current	$I_{ZCR(SINK)}$		-	-	3000	$\mu A$
Nonlinearity	$L_{INERR}$		-	0.1	0.5	%
Symmetry	$Sym_{ERR}$		-	0.5	1.5	%
Power-on Time	$T_{POR}$	Output rising from 0 to 90% of steady-state	-	10	-	$\mu s$

**5A PERFORMANCE CHARACTERISTICS**

Parameter	Symbol	Conditions	Min.	Typ.	Max.	Unit
Current Accuracy Range	$I_P$	-	-5	-	5	A
Sensitivity	Sens	full range of $I_P$	388	400	412	mV/A
Zero Current Differential Output Error	$V_{OE}$		-45		45	mV
Noise	$V_{NOISE(P-P)}$		-	70	-	mV
Zero Current Output Slope	$\Delta V_{OUT(Q)}$		-	0.34	-	mV/°C
Sensitivity Slope	$\Delta SENS$		-	0.03	-	mV/A /°C
Total Output Error	$E_{TOT}$		-3.0	-	3.0	%

**10A PERFORMANCE CHARACTERISTICS**

Parameter	Symbol	Conditions	Min.	Typ.	Max.	Unit
Current Accuracy Range	$I_P$	-	-10	-	10	A
Sensitivity	Sens	full range of $I_P$	194	200	206	mV/A
Zero Current Differential Output Error	$V_{OE}$		-40		40	mV
Noise	$V_{NOISE(P-P)}$		-	55	-	mV
Zero Current Output Slope	$\Delta V_{OUT(Q)}$		-	0.34	-	mV/°C
Sensitivity Slope	$\Delta SENS$		-	0.03	-	mV/A /°C
Total Output Error	$E_{TOT}$		-3.0	-	3.0	%

**20A PERFORMANCE CHARACTERISTICS**

Parameter	Symbol	Conditions	Min.	Typ.	Max.	Unit
Current Accuracy Range	$I_P$	-	-20	-	20	A
Sensitivity	Sens	full range of $I_P$	97	100	103	mV/A
Zero Current Differential Output Error	$V_{OE}$		-25		25	mV
Noise	$V_{NOISE(P-P)}$		-	35	-	mV
Zero Current Output Slope	$\Delta V_{OUT(Q)}$		-	0.34	-	mV/°C
Sensitivity Slope	$\Delta SENS$		-	0.02	-	mV/A /°C
Total Output Error	$E_{TOT}$		-3.0	-	3.0	%

**25A PERFORMANCE CHARACTERISTICS**

Parameter	Symbol	Conditions	Min.	Typ.	Max.	Unit
Current Accuracy Range	$I_P$	-	-25	-	25	A
Sensitivity	Sens	full range of $I_P$	77.6	80	82.4	mV/A
Zero Current Differential Output Error	$V_{OE}$		-20		20	mV
Noise	$V_{NOISE(P-P)}$		-	30	-	mV
Zero Current Output Slope	$\Delta V_{OUT(Q)}$		-	0.34	-	mV/°C
Sensitivity Slope	$\Delta SENS$		-	0.017	-	mV/A /°C
Total Output Error	$E_{TOT}$		-3.0	-	3.0	%

**30A PERFORMANCE CHARACTERISTICS**

Parameter	Symbol	Conditions	Min.	Typ.	Max.	Unit
Current Accuracy Range	$I_P$	-	-30	-	30	A
Sensitivity	Sens	full range of $I_P$	65	67	69	mV/A
Zero Current Differential Output Error	$V_{OE}$		-15		15	mV
Noise	$V_{NOISE(P-P)}$		-	30	-	mV
Zero Current Output Slope	$\Delta V_{OUT(Q)}$		-	0.28	-	mV/°C
Sensitivity Slope	$\Delta SENS$		-	0.015	-	mV/A /°C
Total Output Error	$E_{TOT}$		-3.0	-	3.0	%

**40A PERFORMANCE CHARACTERISTICS**

Parameter	Symbol	Conditions	Min.	Typ.	Max.	Unit
Current Accuracy Range	$I_P$	-	-40	-	40	A
Sensitivity	Sens	full range of $I_P$	48.5	50	51.5	mV/A
Zero Current Differential Output Error	$V_{OE}$		-10		10	mV
Noise	$V_{NOISE(P-P)}$		-	25	-	mV
Zero Current Output Slope	$\Delta V_{OUT(Q)}$		-	0.21	-	mV/°C
Sensitivity Slope	$\Delta SENS$		-	0.01	-	mV/A /°C
Total Output Error	$E_{TOT}$		-3.0	-	3.0	%

**50A PERFORMANCE CHARACTERISTICS**

Parameter	Symbol	Conditions	Min.	Typ.	Max.	Unit
Current Accuracy Range	$I_P$	-	-50	-	50	A
Sensitivity	Sens	full range of $I_P$	38.8	40	41.2	mV/A
Zero Current Differential Output Error	$V_{OE}$		-10		10	mV
Noise	$V_{NOISE(P-P)}$		-	25	-	mV
Zero Current Output Slope	$\Delta V_{OUT(Q)}$		-	0.17	-	mV/°C
Sensitivity Slope	$\Delta SENS$		-	0.01	-	mV/A /°C
Total Output Error	$E_{TOT}$		-3.0	-	3.0	%

TYPICAL APPLICATION CIRCUITS

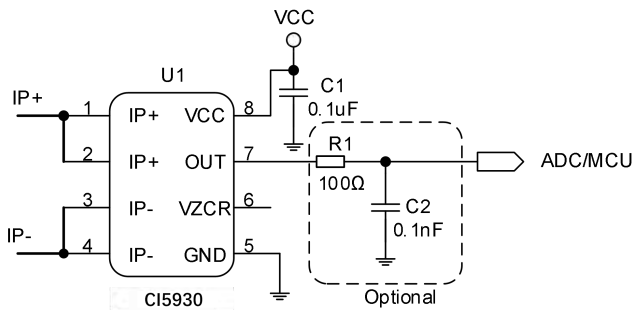

Typical Output Application

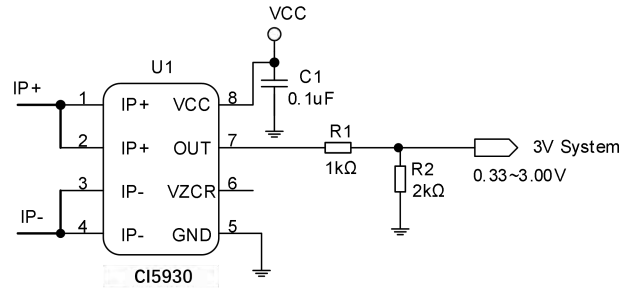

Signal Attenuation Circuit

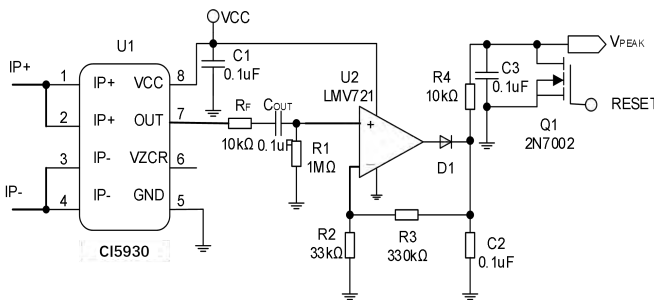

Peak Current Detection

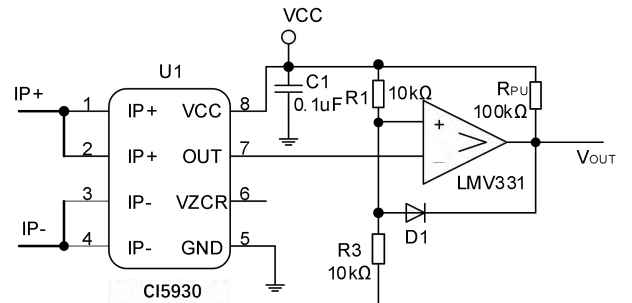

Over Current Fault Latch

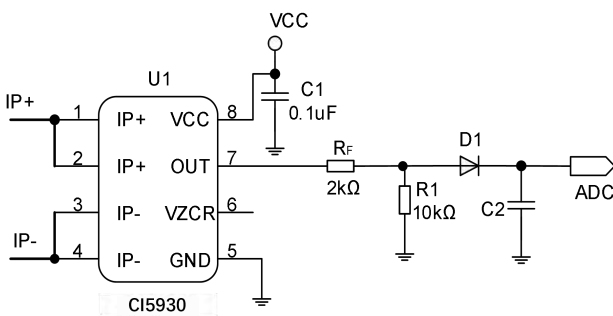

Rectifier output, instead of current transformer application

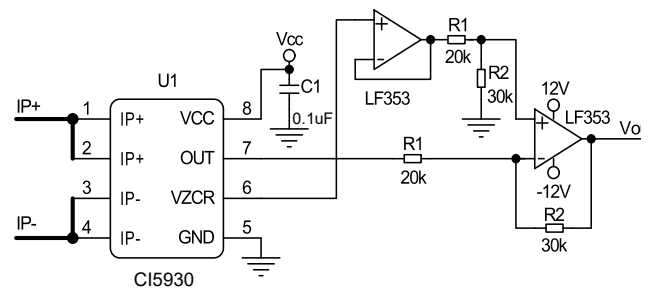

Zero Migration Application

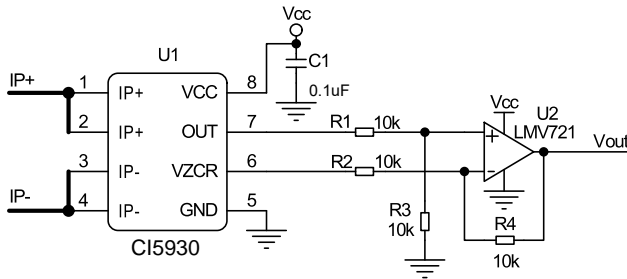
**TYPICAL APPLICATION CIRCUITS**

Application of single source zero shift with unidirectional current

**Note:** the output current of IZCR is < 0.4mA. It is suggested that 0.3mA should be reserved in design

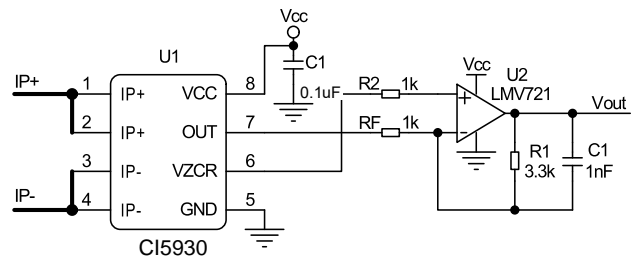

Gain amplifier application

**Note:** output direction of VOUT

## Function Description

The CI5930 device is a precision current sensor based on Hall sensor. It has 424V<sub>RMS</sub> basic isolated working voltage, less than 3% full scale error and zero current reference signal output in the whole temperature range, which can realize unidirectional or bidirectional current detection. The input current flows through a wire between isolated input current pins, which has a resistance of 0.9 mΩ at room temperature to reduce insertion loss. The magnetic field generated by the input current is sensed by Hall sensor and amplified by precise signal chain. It can be used for AC and DC current measurement with a bandwidth of 250kHz. The measuring current is 5-50A. There are 7 kinds of Current sensing range to choose. It can work under single power supply of 4.5V to 5.5V. CI5930 is optimized for high accuracy and temperature stability, compensating for misalignment and sensitivity over the entire range.

The input current of CI5930 flows through the primary side of the package through IP + and IP – pins, the current flowing through the chip generates a magnetic field proportional to the input current and is measured by an isolated Precision Hall sensor IC. Compared with other current measurement methods, the low impedance lead frame path reduces power consumption and does not require any external devices on the primary side. In addition, the internal integrated differential common mode suppression circuit can make the chip output not affected by external interference magnetic signal, and only measure the magnetic field generated by the input current, so as to suppress the interference of external magnetic field.

The typical resistance of the primary current input conductor at 25 ° C is 0.9 mΩ. The lead frame is made of copper. The temperature coefficient of the input wire is positive, and the wire resistance increases with the increase of temperature. The typical temperature coefficient is 3300 ppm/° C. For every 100 ° C increase in temperature, the primary side resistance will increase by 33%.

## Input Current

In use, the primary side of the chip (package pins 1-4) is connected in series at any position in the whole circuit. The input current flowing from IP + (package pins 1-2) to IP - (package pins 3-4) is positive, otherwise it is negative. Do not shunt resistors between IP + and IP -, unless there are very special reasons - such as minimizing insertion loss - which will reduce the current flowing through the chip, and the wire resistance will also be affected by temperature drift, which requires external temperature and precision correction of the whole system.

## Output Characteristic

The static output point (IP = 0A) of CI5930 is  $V_{CC} / 2$ .

When the current increases, the  $V_{OUT}$  increases until the saturation voltage of the output operational amplifier ( $V_{CC}$  – rail voltage); when the current decreases, the  $V_{OUT}$  decreases until the saturation voltage ( $GND$  + rail voltage) of the Output Op Amp. Crosschip ensures the accuracy and linearity of  $V_{OUT}$  in the range of 0.5 ~ 4.5V. In order to ensure the consistency of mass manufacturing, there is a certain margin in this range, but it is not recommended for customers to use this margin.

When the input current exceeds the range, the output of  $V_{OUT}$  is close to the rail voltage of the power supply. When the input current does not exceed the tolerance limit of the chip, the voltage will always be maintained. After the input current returns to the range, the output of  $V_{OUT}$  will return to normal without any damage to the chip.

Product Name	Input Current	Sensitivity (mV/A)	Calculation Formula (Note 1)
CI5930-05A	-5A ~ +5A	400	$V_{OUT} = V_{CC} / 2 + 0.400 \times I_P(A) \dots\dots(V)$
CI5930-10A	-10A ~ +10A	200	$V_{OUT} = V_{CC} / 2 + 0.200 \times I_P(A) \dots\dots(V)$
CI5930-20A	-20A ~ +20A	100	$V_{OUT} = V_{CC} / 2 + 0.100 \times I_P(A) \dots\dots(V)$
CI5930-25A	-25A ~ +25A	80	$V_{OUT} = V_{CC} / 2 + 0.080 \times I_P(A) \dots\dots(V)$
CI5930-30A	-30A ~ +30A	67	$V_{OUT} = V_{CC} / 2 + 0.067 \times I_P(A) \dots\dots(V)$
CI5930-40A	-40A ~ +40A	50	$V_{OUT} = V_{CC} / 2 + 0.050 \times I_P(A) \dots\dots(V)$
CI5930-50A	-50A ~ +50A	40	$V_{OUT} = V_{CC} / 2 + 0.040 \times I_P(A) \dots\dots(V)$

**Note:** the formula is only applicable to DC current calculation. When AC current is applied, pay attention to  $I_{PEAK} = 1.414 \times I_{RMS}$  and the positive & negative current direction.

**Relationship between Package Temperature & Input Current**

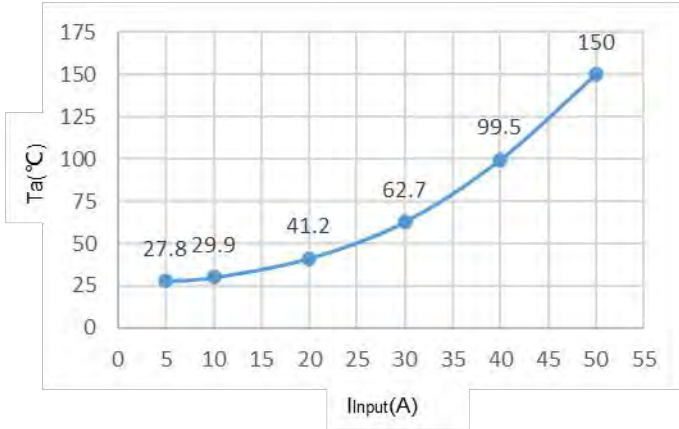

Input Current (IP) vs. Package temperature

Note: Based on the demo board test, for specific applications, it is necessary to strengthen the heat dissipation according to the actual application scenario or select the board with high Tg.

For example: Temperature tests shall be considered for the specific installation conditions in end system which needs a cooling system that can provide wind speeds of at least 10.8 m/s.

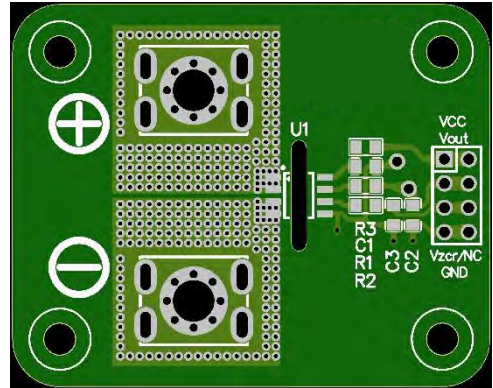

Thickness: 1.6mm, FR-4 double-sided plate, 2oz copper foil total 1200m2

Test environment: open environment, stagnant air

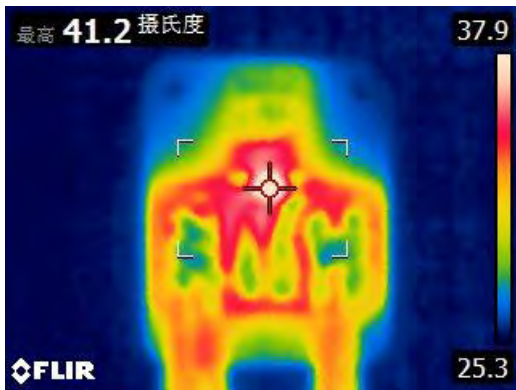

Package Thermography (Input Current 20A)

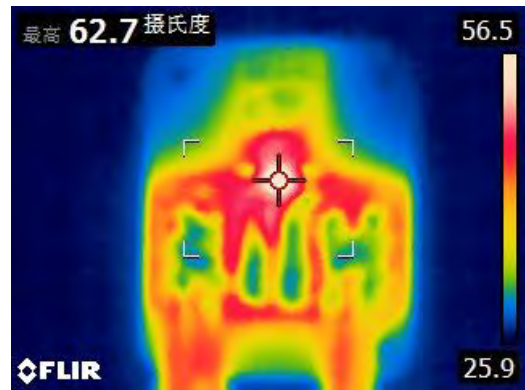

Package Thermography (Input Current 30A)



Package Thermography (Input Current 40A)

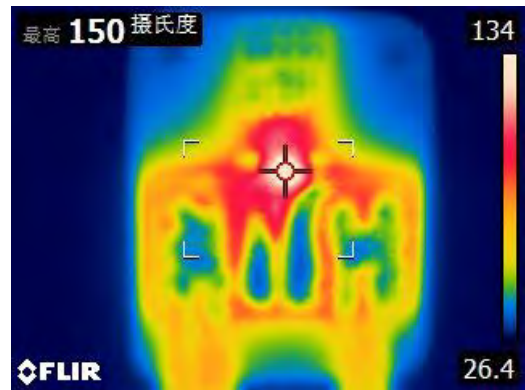

Package Thermography (Input Current 50A)

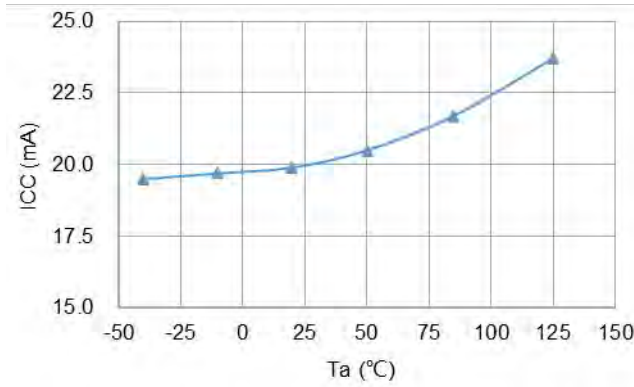
**OUTPUT WAVEFORMS AND CURVES**

Icc vs. Ta

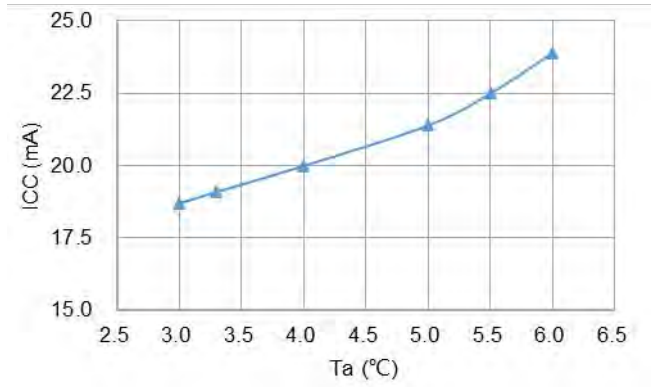

Icc vs. Vcc

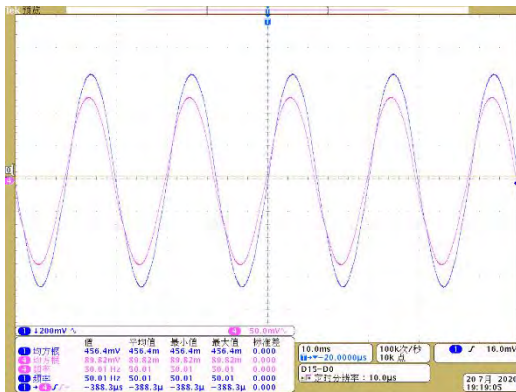

AC output voltage waveform (50Hz)

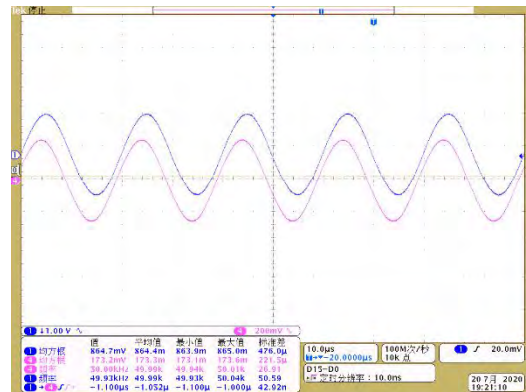

AC output voltage waveform (50kHz)

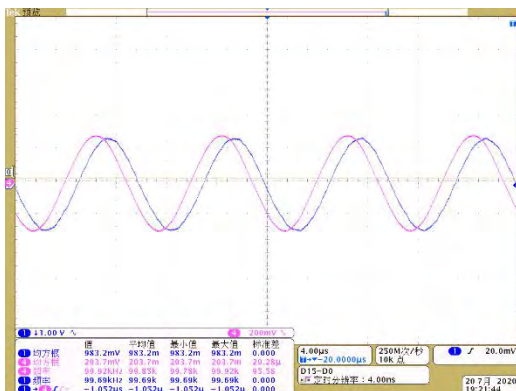

AC output voltage waveform (100kHz)

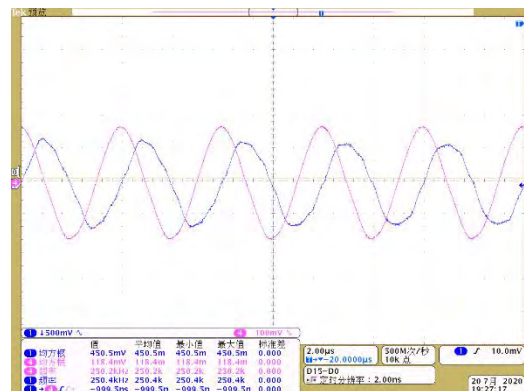

AC output voltage waveform (250kHz)

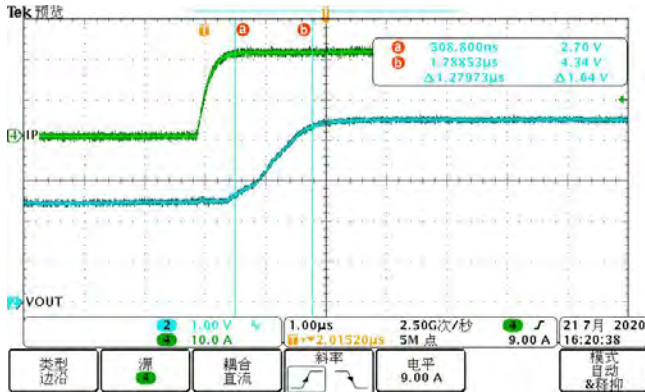
**OUTPUT WAVEFORMS AND CURVES**

 V<sub>OUT</sub> vs IP (20A)

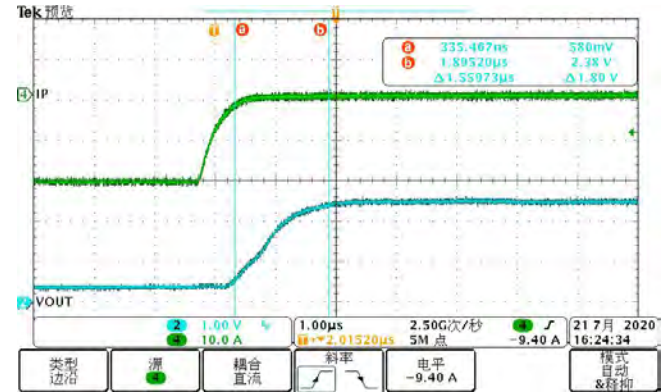
(Positive Current Rising Edge Response)

 V<sub>OUT</sub> vs IP (20A)

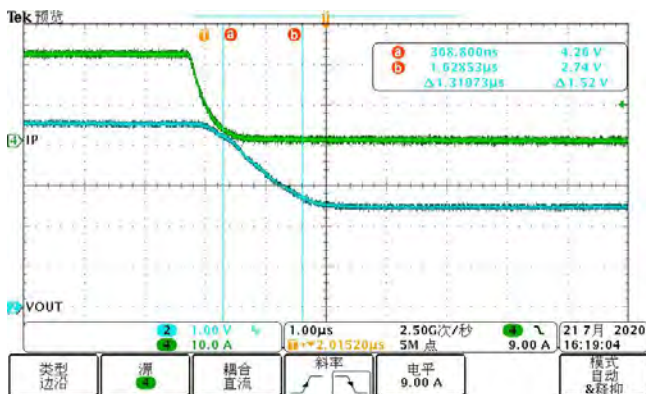
(Negative Current Rising Edge Response)

 V<sub>OUT</sub> vs IP (20A)

(Positive Current Falling Edge Response)

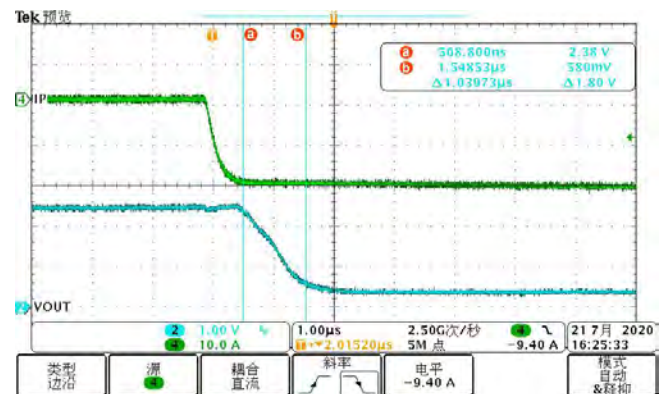
 V<sub>OUT</sub> vs IP (20A)

(Negative Current Falling Edge Response)

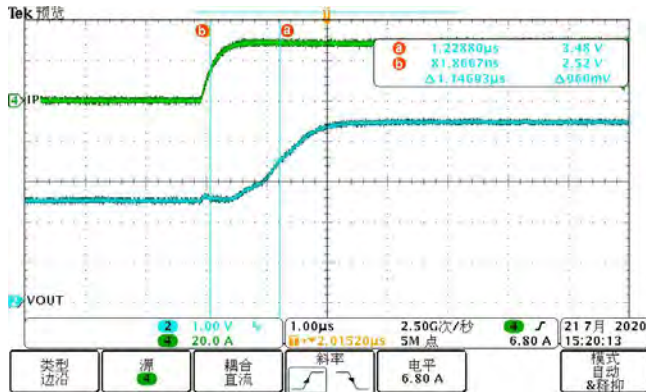
**OUTPUT WAVEFORMS AND CURVES**

 V<sub>OUT</sub> vs IP (30A)

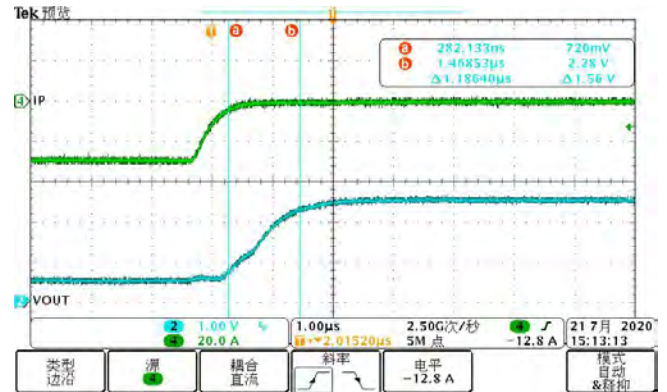
(Positive Current Rising Edge Response)

 V<sub>OUT</sub> vs IP (30A)

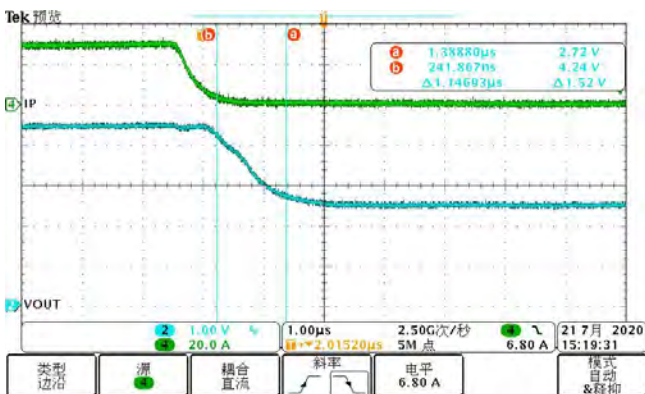
(Negative Current Rising Edge Response)

 V<sub>OUT</sub> vs IP (30A)

(Positive Current Falling Edge Response)

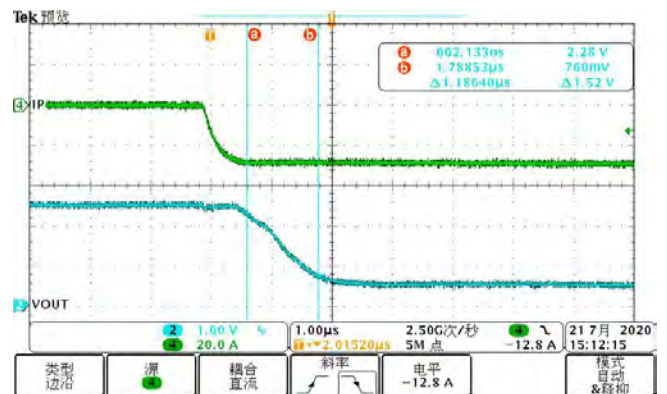
 V<sub>OUT</sub> vs IP (30A)

(Negative Current Falling Edge Response)

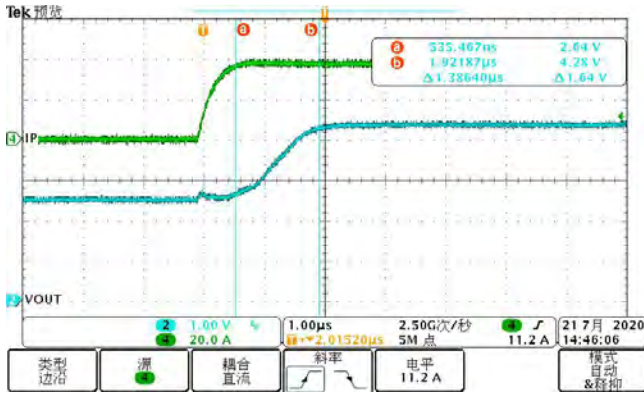
**OUTPUT WAVEFORMS AND CURVES**

 $V_{OUT}$  vs  $I_P$  (40A)

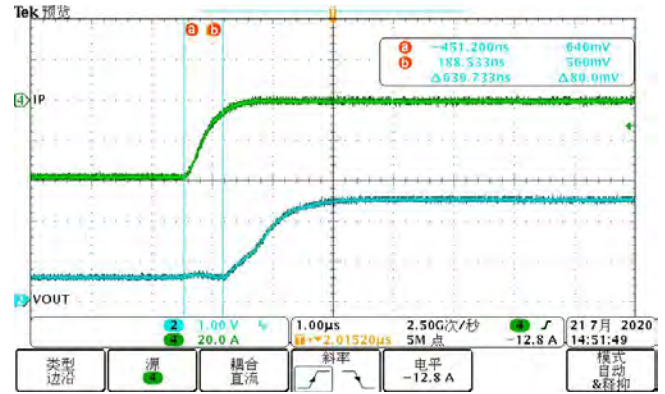
(Positive Current Rising Edge Response)

 $V_{OUT}$  vs  $I_P$  (40A)

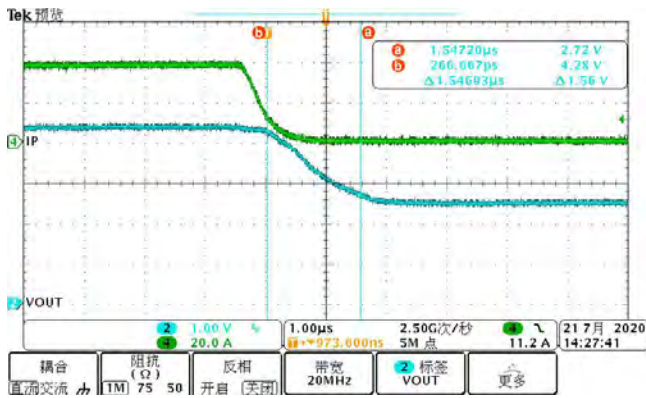
(Negative Current Rising Edge Response)

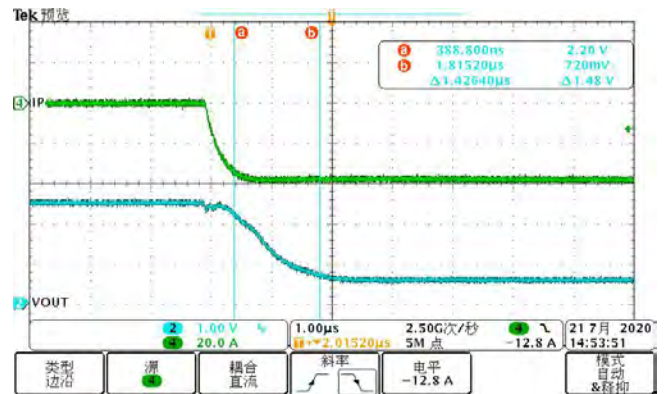

 $V_{OUT}$  vs  $I_P$  (40A)

(Positive Current Falling Edge Response)

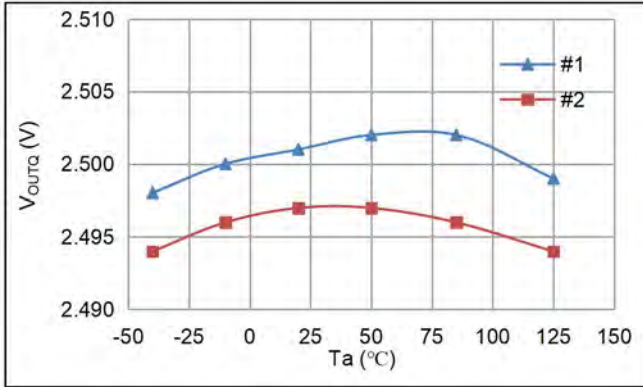
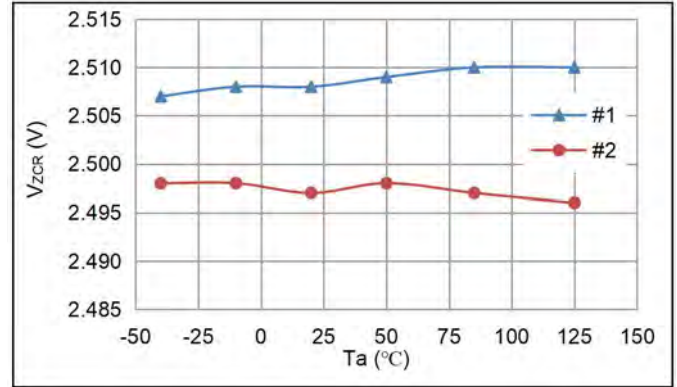
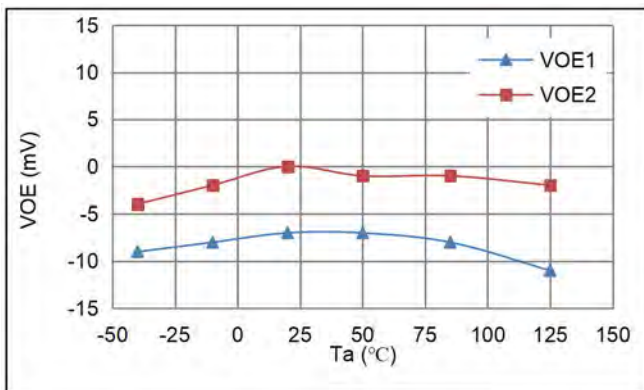
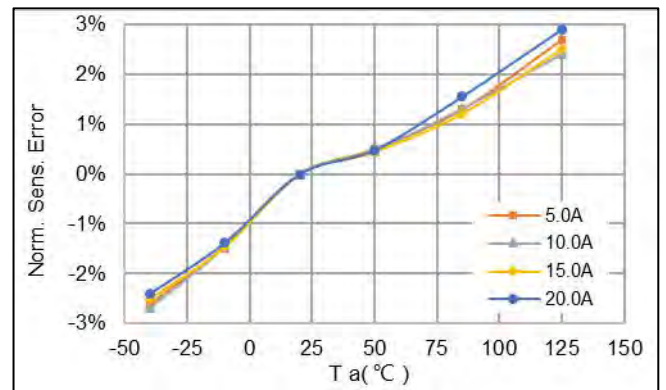
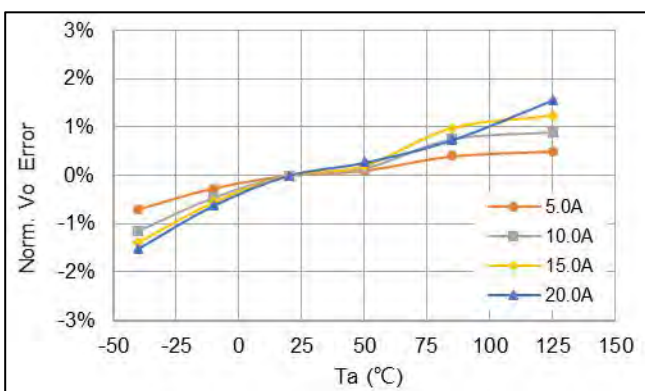
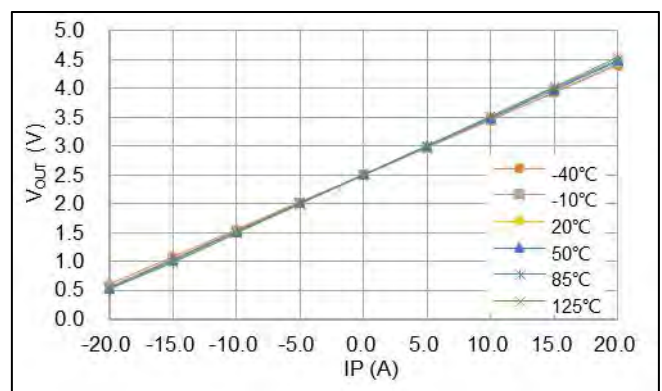

 $V_{OUT}$  vs  $I_P$  (40A)

(Negative Current Falling Edge Response)

## 20A

 V<sub>outQ</sub> vs. T<sub>a</sub>

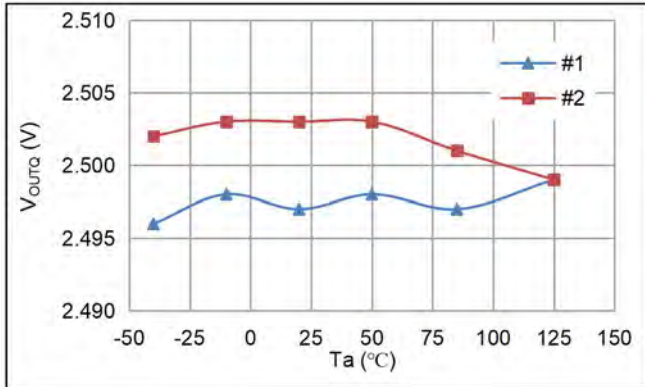
 V<sub>zCR</sub> vs. T<sub>a</sub>

 V<sub>OE</sub> vs. T<sub>a</sub>

 Sens error vs. T<sub>a</sub>

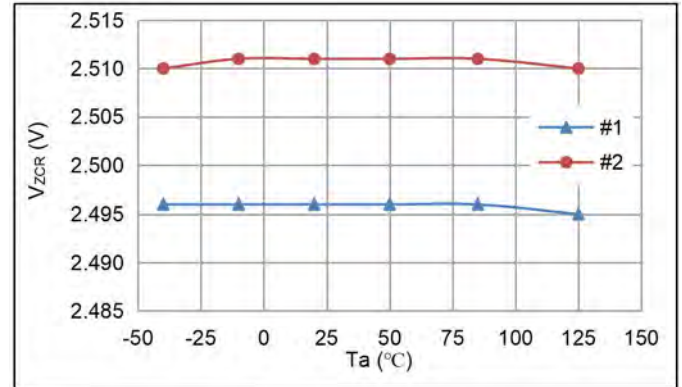
 V<sub>OUT</sub> error vs. T<sub>a</sub>

 V<sub>OUT</sub> vs. I<sub>P</sub>

## 30A



Voutq vs. Ta



Vzcr vs. Ta

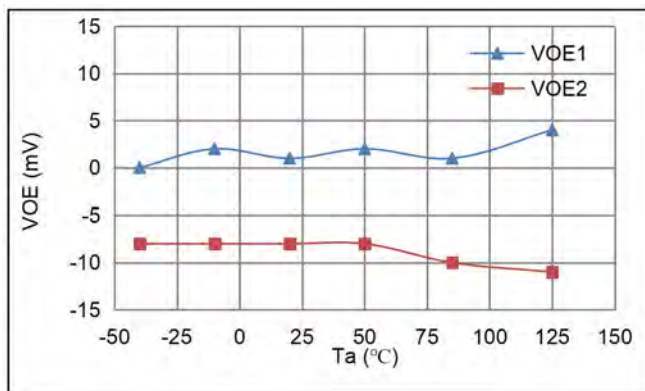

VOE vs. Ta

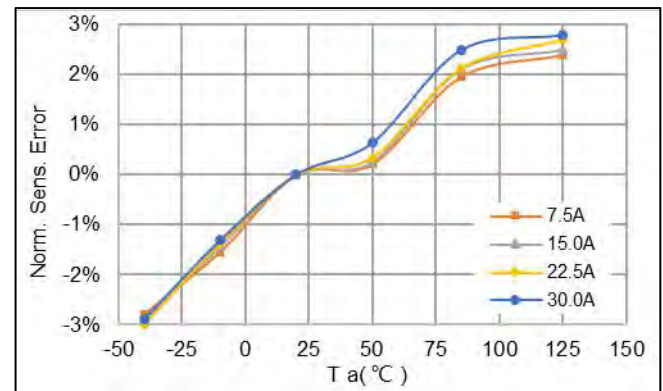

Sens error vs. Ta

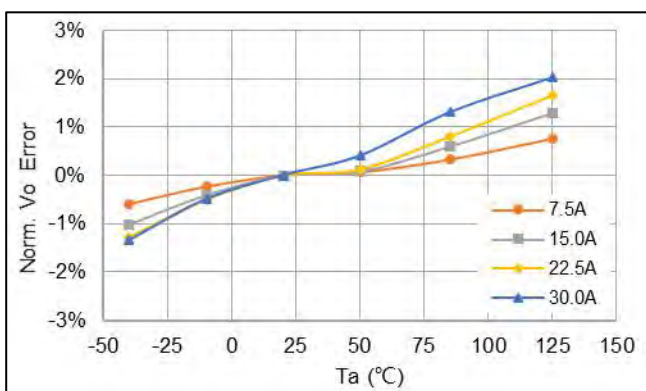

VOUT error vs. Ta

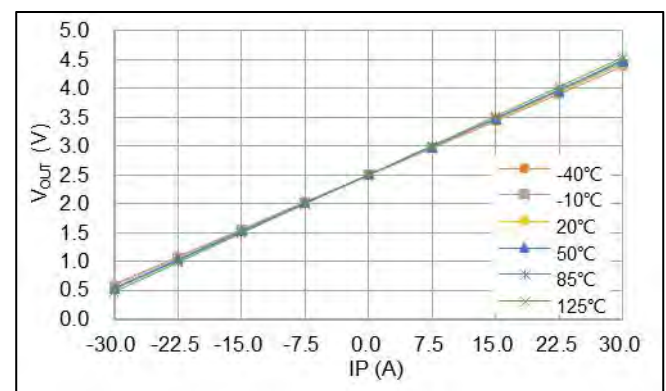

VOUT vs. IP

## 40A

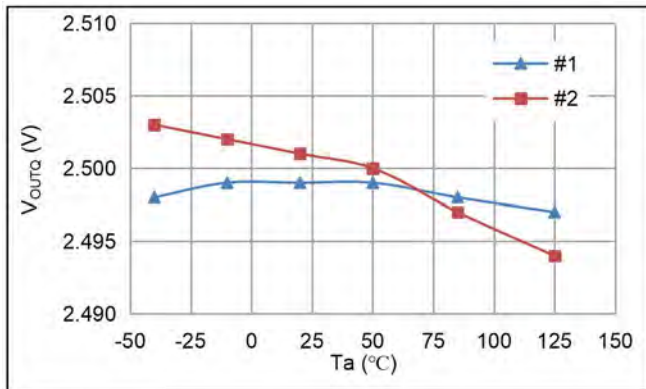
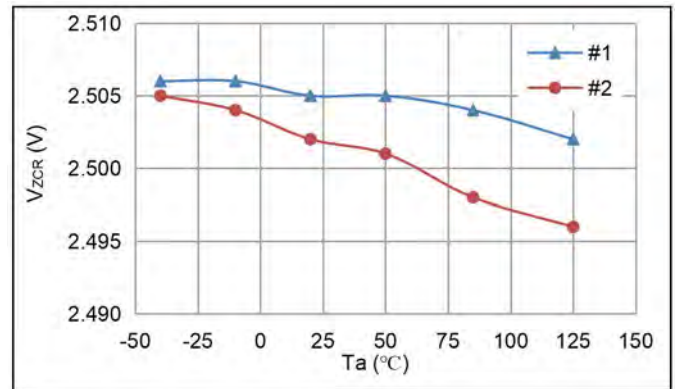
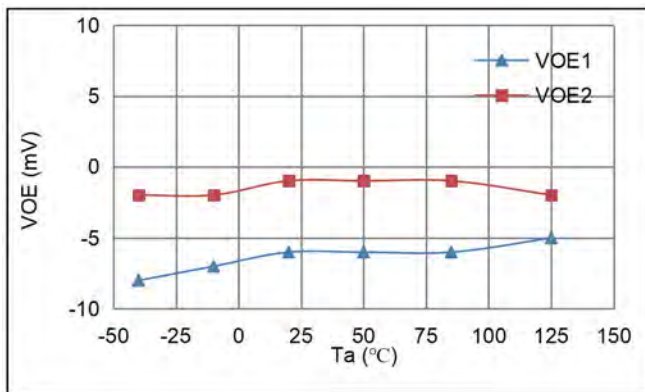
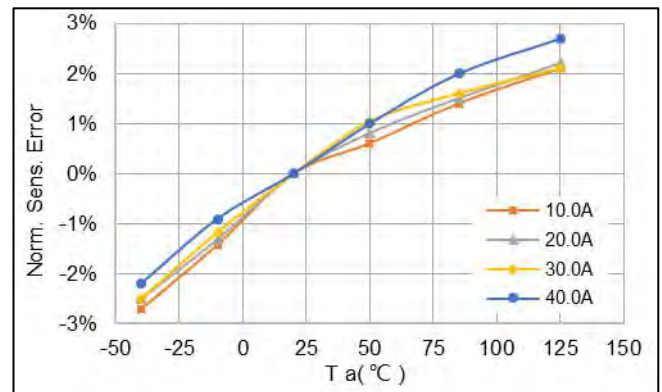
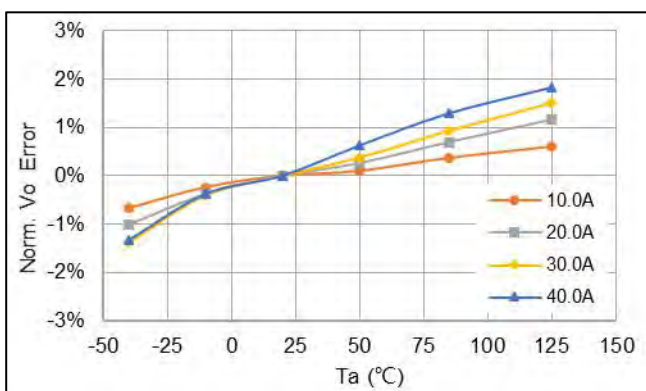
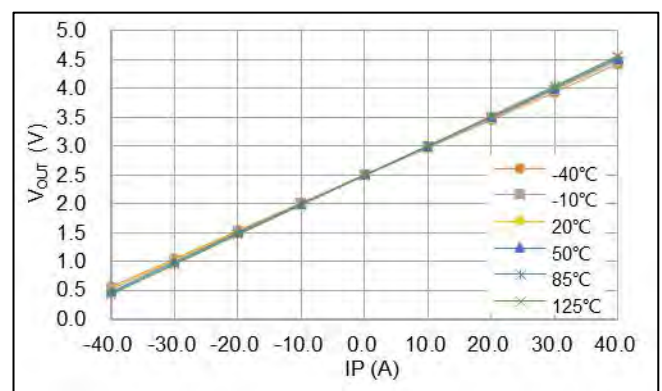

 V<sub>outQ</sub> vs. T<sub>a</sub>

 V<sub>zCR</sub> vs. T<sub>a</sub>

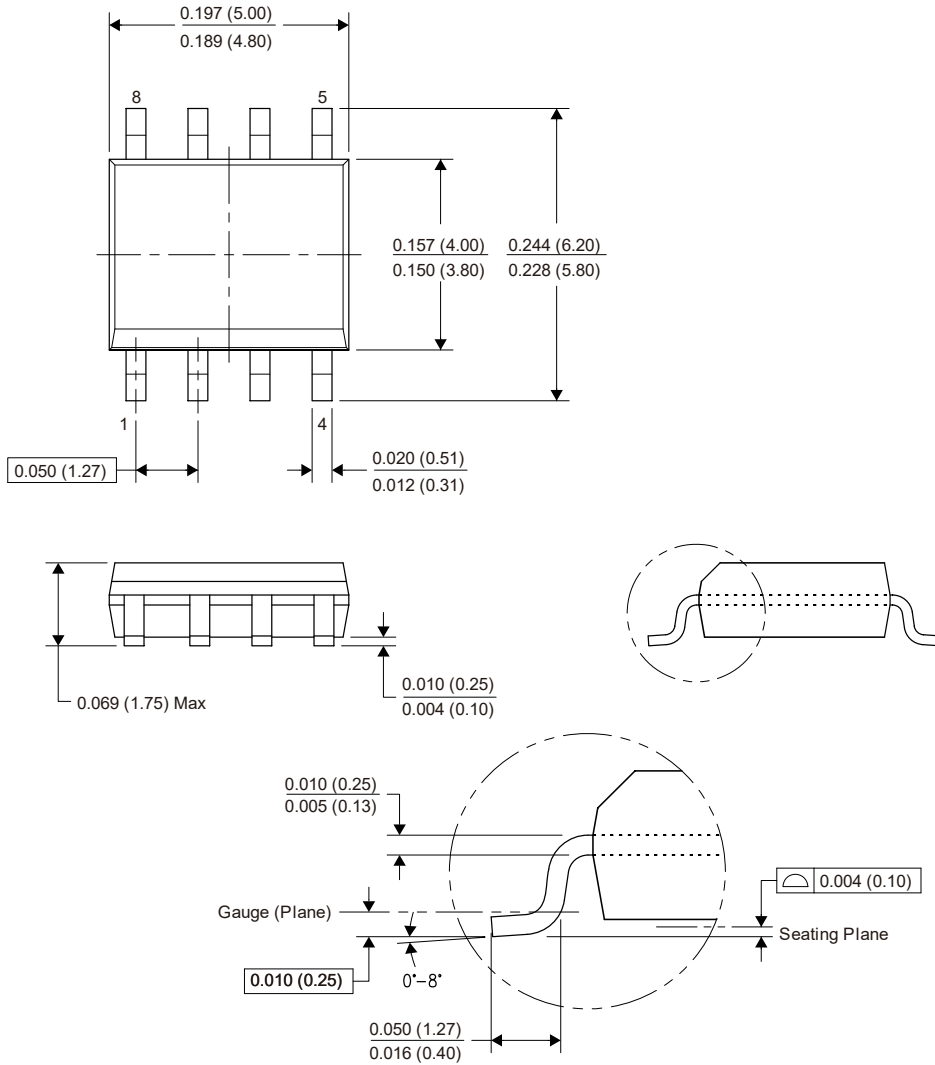
 V<sub>oE</sub> vs. T<sub>a</sub>

 Sens error vs. T<sub>a</sub>

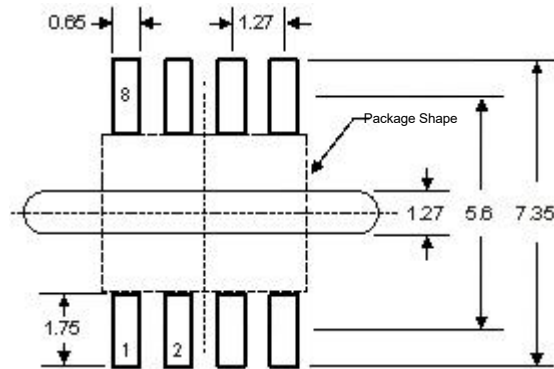
 V<sub>out</sub> error vs. T<sub>a</sub>

 V<sub>out</sub> vs. I<sub>P</sub>

**PACKAGE INFORMATION**

**SOP8 PACKAGE**



**Package Reference**



Reference 1: PCB slotting increases creepage distance

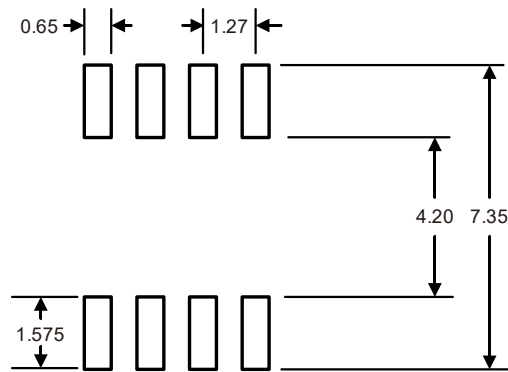

Reference 2: shorten pad length and increase creepage distance

**Packaging & Taping**

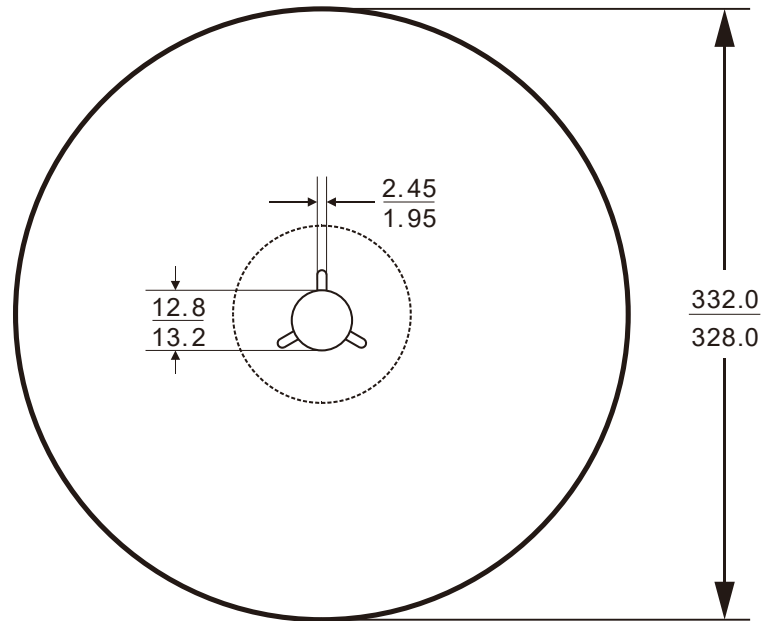

Information of Reel size

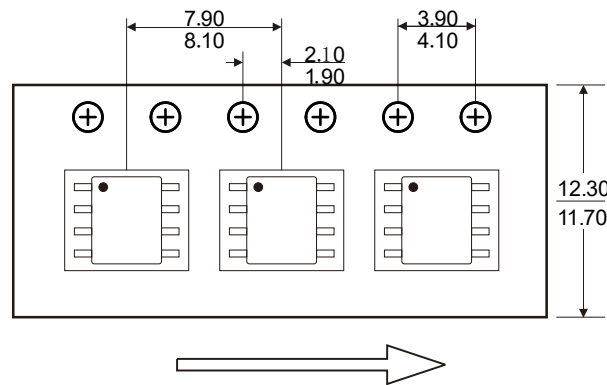

User Direction of Feed

Note: The space between the front and back of each tape is  $50 \pm 2$  grids