

Features

- Epitaxial planar die construction
- Built-in biasing resistors (R_1 : 22k Ω , R_2 : 22k Ω)
- Also available in lead free version
- RoHS compliant with Halogen-free

Mechanical Data

- Case: SOT-23
- Molding Compound: UL Flammability Classification Rating 94V-0
- Terminals: Matte tin-plated leads; solderability-per MIL-STD-202, Method 208

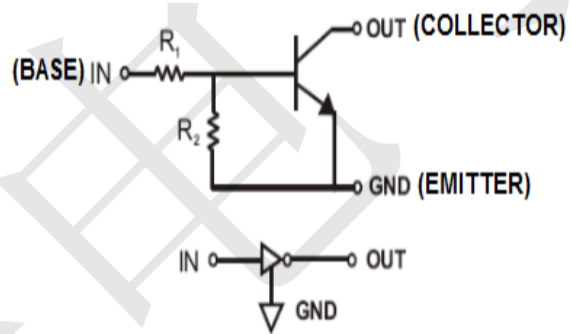
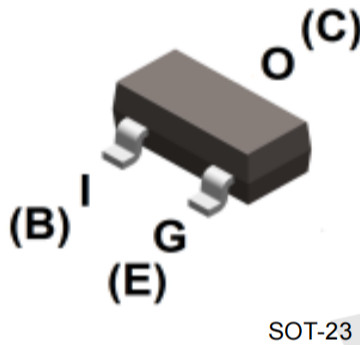

Maximum Ratings (@ $T_A = 25^\circ\text{C}$ unless otherwise specified)

Parameter	Symbol	Value	Unit
		SOT-23	
Supply Voltage	V_{CC}	50	V
Input Voltage	V_I	-10 to +40	V
Output Current	I_O	30	mA
Collector Current	$I_{C(Max)}$	100	mA
Power Dissipation	P_D	200	mW
Junction Temperature Range	T_J	-55 ~ +150	$^\circ\text{C}$
Storage Temperature Range	T_{STG}	-55 ~ +150	$^\circ\text{C}$

Electrical Characteristics (@ $T_A = 25^\circ\text{C}$ unless otherwise specified)

Parameter	Symbol	Test Condition	Min.	Typ.	Max.	Unit
Input Voltage	$V_{I(OFF)}$	$V_{CC} = 5V, I_O = 100\mu A$	0.5	-	-	V
Input Voltage	$V_{I(ON)}$	$V_O = 0.2V, I_O = 5mA$	-	-	3	V
Output Voltage	$V_{O(on)}$	$I_O = 10mA, I_I = 0.5mA$	-	-	0.3	V
Input Current	I_I	$V_I = 5V$	-	-	0.36	mA
Output Current	$I_{O(off)}$	$V_{CC} = 50V, V_I = 0V$	-	-	0.5	μA
DC Current Gain	G_I	$V_O = 5V, I_O = 5mA$	56	-	-	-
Input Resistor	R_I		15.4	22	28.6	k Ω
Resistance ratio	R_2/R_1		0.8	1.0	1.2	-
Gain-Bandwidth Product	f_T	$V_{CE} = 10V, I_E = 5mA$ $f = 100MHz$	-	250	-	MHz

Ratings and Characteristic Curves (@ $T_A = 25^\circ\text{C}$ unless otherwise specified)

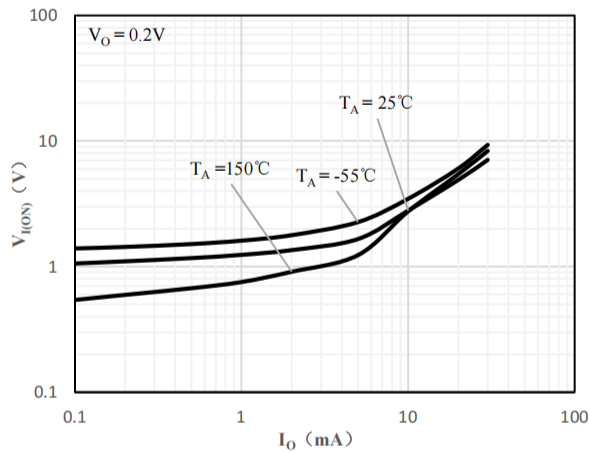

Fig 1 Input Voltage vs Output Current

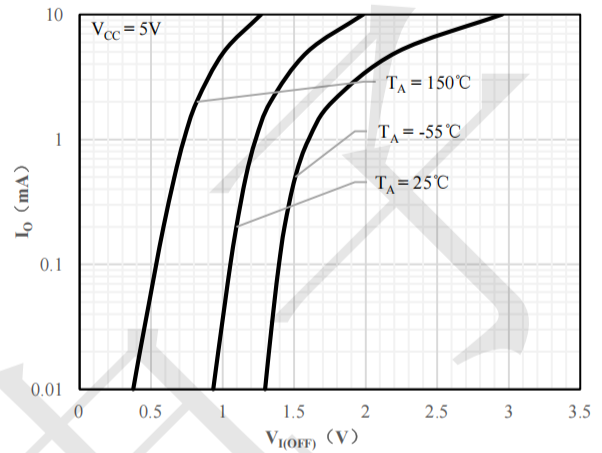

Fig 2 Output Current vs Input Voltage

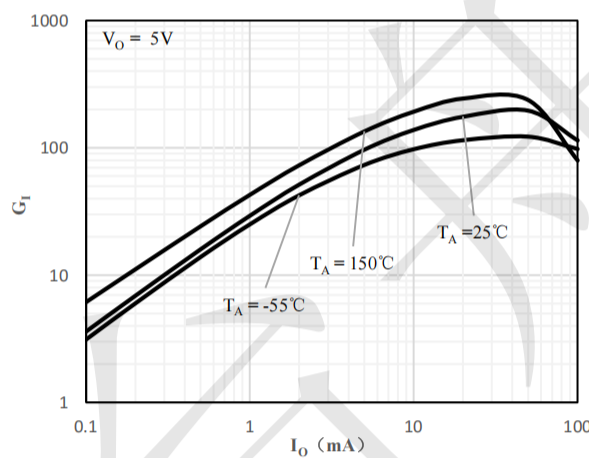

Fig 3 DC Current Gain vs Output Current

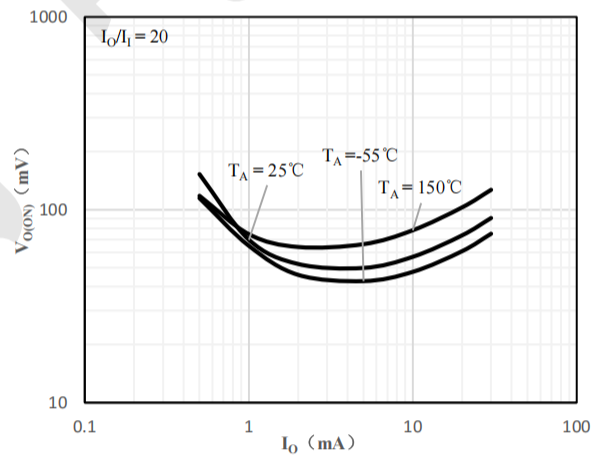

Fig 4 Output Voltage vs Output Current

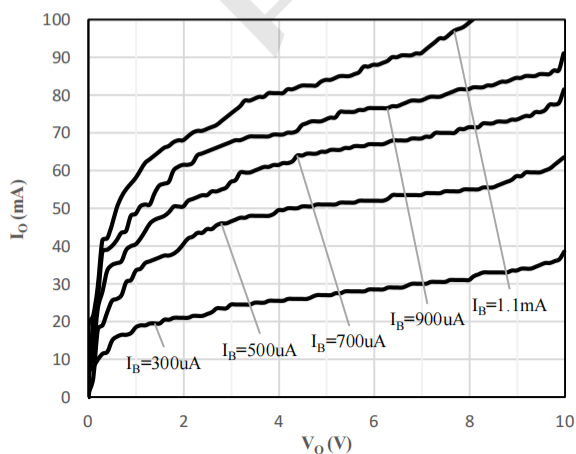
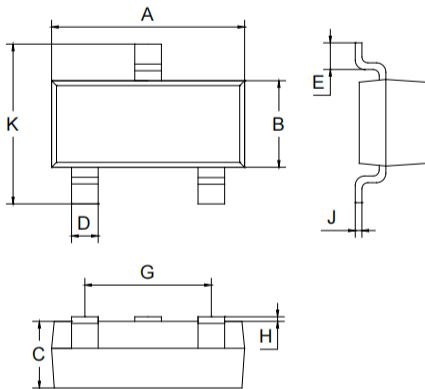

Fig 5 Output Current vs. Output Voltage

Package Outline Dimensions (Unit: mm)

SOT-23



SOT-23		
Dimension	Min.	Max.
A	2.70	3.10
B	1.10	1.50
C	0.90	1.10
D	0.30	0.50
E	0.35	0.48
G	1.80	2.00
H	0.02	0.10
J	0.05	0.15
K	2.20	2.60

Package Outline Dimensions (Unit: mm)

